

ON Semiconductor

Is Now

onsemi™

To learn more about onsemi™, please visit our website at
www.onsemi.com

onsemi and **onsemi** and other names, marks, and brands are registered and/or common law trademarks of Semiconductor Components Industries, LLC dba "**onsemi**" or its affiliates and/or subsidiaries in the United States and/or other countries. **onsemi** owns the rights to a number of patents, trademarks, copyrights, trade secrets, and other intellectual property. A listing of **onsemi** product/patent coverage may be accessed at www.onsemi.com/site/pdf/Patent-Marking.pdf. **onsemi** reserves the right to make changes at any time to any products or information herein, without notice. The information herein is provided "as-is" and **onsemi** makes no warranty, representation or guarantee regarding the accuracy of the information, product features, availability, functionality, or suitability of its products for any particular purpose, nor does **onsemi** assume any liability arising out of the application or use of any product or circuit, and specifically disclaims any and all liability, including without limitation special, consequential or incidental damages. Buyer is responsible for its products and applications using **onsemi** products, including compliance with all laws, regulations and safety requirements or standards, regardless of any support or applications information provided by **onsemi**. "Typical" parameters which may be provided in **onsemi** data sheets and/or specifications can and do vary in different applications and actual performance may vary over time. All operating parameters, including "Typicals" must be validated for each customer application by customer's technical experts. **onsemi** does not convey any license under any of its intellectual property rights nor the rights of others. **onsemi** products are not designed, intended, or authorized for use as a critical component in life support systems or any FDA Class 3 medical devices or medical devices with a same or similar classification in a foreign jurisdiction or any devices intended for implantation in the human body. Should Buyer purchase or use **onsemi** products for any such unintended or unauthorized application, Buyer shall indemnify and hold **onsemi** and its officers, employees, subsidiaries, affiliates, and distributors harmless against all claims, costs, damages, and expenses, and reasonable attorney fees arising out of, directly or indirectly, any claim of personal injury or death associated with such unintended or unauthorized use, even if such claim alleges that **onsemi** was negligent regarding the design or manufacture of the part. **onsemi** is an Equal Opportunity/Affirmative Action Employer. This literature is subject to all applicable copyright laws and is not for resale in any manner. Other names and brands may be claimed as the property of others.

NCP370GEVB

NCP370 Over Voltage Protection Controller with Reverse Charge Control Evaluation Board User's Manual



ON Semiconductor®

<http://onsemi.com>

Description

The NCP370 is an overvoltage, overcurrent and reverse control device. Two main modes are available by setting logic pins.

First mode is Direct Mode from Wall Adapter to the system. In this mode the system is both positive and negative overvoltage protected up to +28 V and down to -28 V. The wall adapter is disconnected from the system if the input voltage exceeds the overvoltage (OVLO) or undervoltage (UVLO) thresholds. At powerup, the V_{out} turns on 30 ms after the V_{in} exceeds the undervoltage threshold.

The second mode, called the Reverse Mode, allows an external accessory to be powered by the system battery or a boost converter. Here, the external accessory would be connected to the device input (bottom connector of system) and the device battery would be at the device output. In this case, overcurrent protection is activated to prevent accessory faults and battery discharge. Thanks to the NCP370 using an internal NMOS, the system cost and the PCB area of the application board are minimized. The NCP370 provides a negative going flag (FLAG(BAR)) output which alerts the system that a fault has occurred. In addition, the device has ESD protected input (15 kV Air) when bypassed with a 1.0 μ F or larger capacitor.

EVAL BOARD USER'S MANUAL

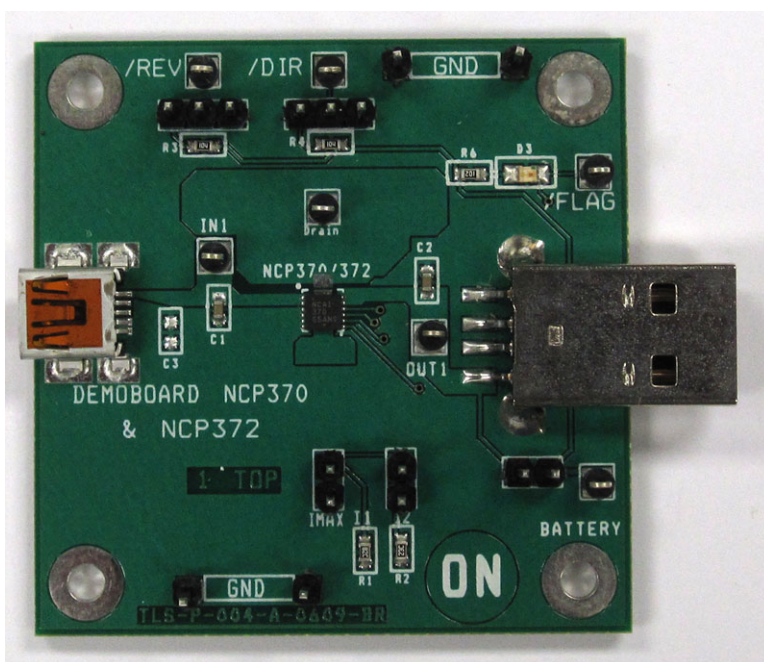

Figure 1. NCP370GEVB Board Picture

NCP370GEVB

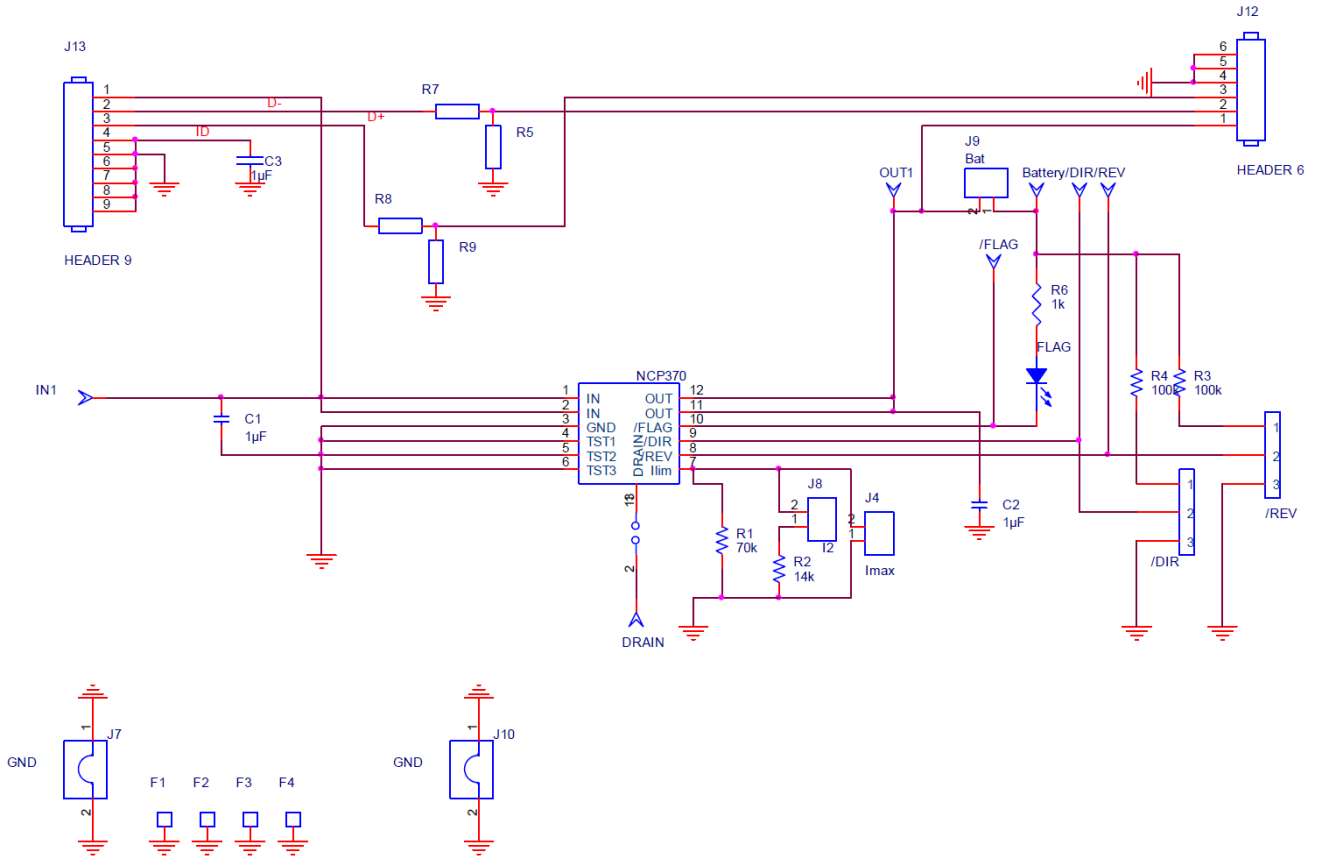

Figure 2. NCP370GEVB Board Schematic

NCP370GEVB

Table 1. BILL OF MATERIALS

Quantity	Designation	Manufacturer	Digi key	Specifications
1	NCP370 LLGA3x3	ON Semiconductor		Over voltage protection
2	C1 (Cin), C2 (Cout)	Murata – GRM188R61E105KA12D	490-3897-1-ND	1 μ F 25V X5R CMS0805
1	C3 (ID): not mounted			
13	Test points:IN1, OUT1, BATTERY, FLAG, DRAIN, REV, DIR		5001K-ND	Hole diameter: 1.3mm
1	J13 (USB IN)	Molex	WM17116CT-ND	5 pins USB miniB
1	J12. (USB OUT)	Molex	WM17118-ND	4 pins USB A
1	FLAG	rohm	511-1287-ND	Green LED 0805
1	R6	susumu	Rr08p(value)dct-nd	1 k Ω . CMS0603 0.5%
2	R3, R4	susumu	Rr08p(value)dct-nd	100 k Ω . CMS0603 0.5%
Not mounted	R5,R7,R8,R9 (USB data)			
1	R1	susumu	Rr08p(value)bct-nd	69.8k Ω . CMS0603 0.5%
1	R2	susumu	Rr08p(value)bct-nd	16.9k Ω . CMS0603 0.5%
4	GND jumper: J7, J10		WM8083-ND	Jumper Ground 1mm pitch 10.16 mm
1x3	REV		WM8083-ND	SMB R 114 665 PCB Plated Gold
1x3	DIR		WM8083-ND	SMB R 114 665 PCB Plated Gold
1x2	lmax		WM8083-ND	SMB R 114 665 PCB Plated Gold
1x2	l2		WM8083-ND	SMB R 114 665 PCB Plated Gold
1x2	Battery		WM8083-ND	SMB R 114 665 PCB Plated Gold

NCP370GEVB

PCB

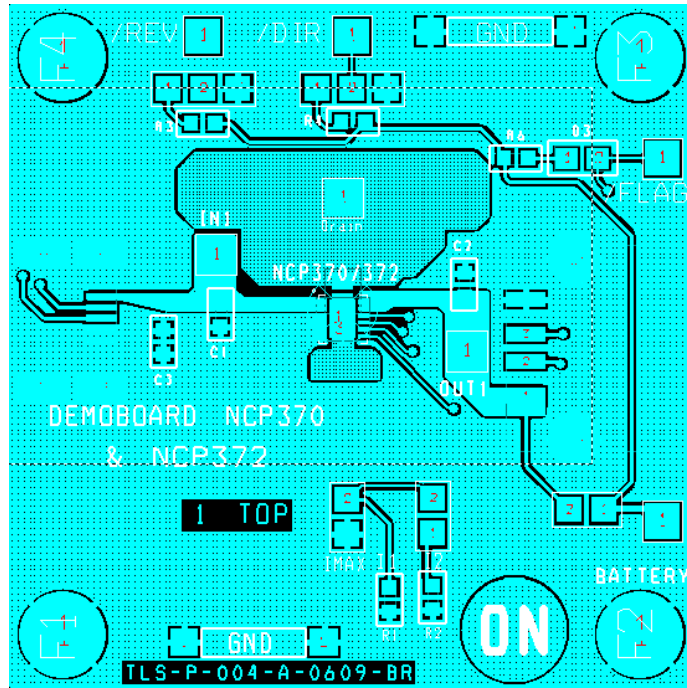

Figure 3. NCP370GEVB Board Layout (Top View)

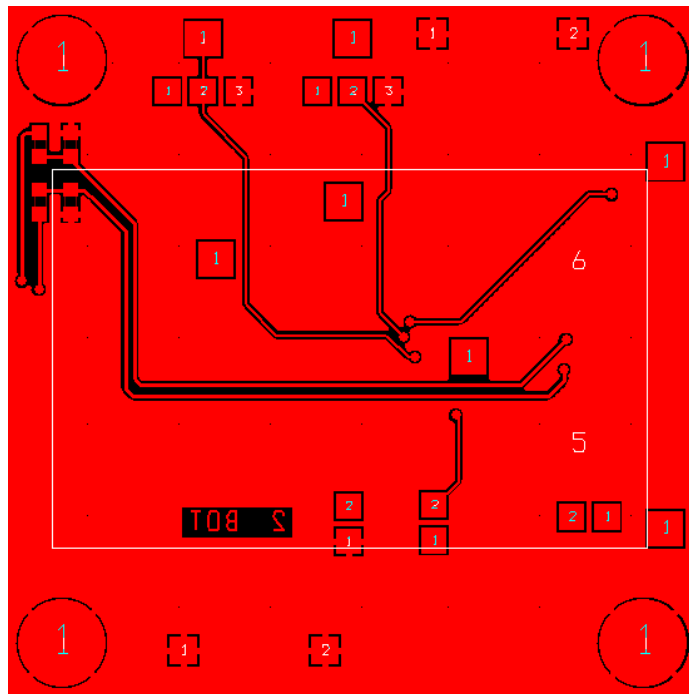
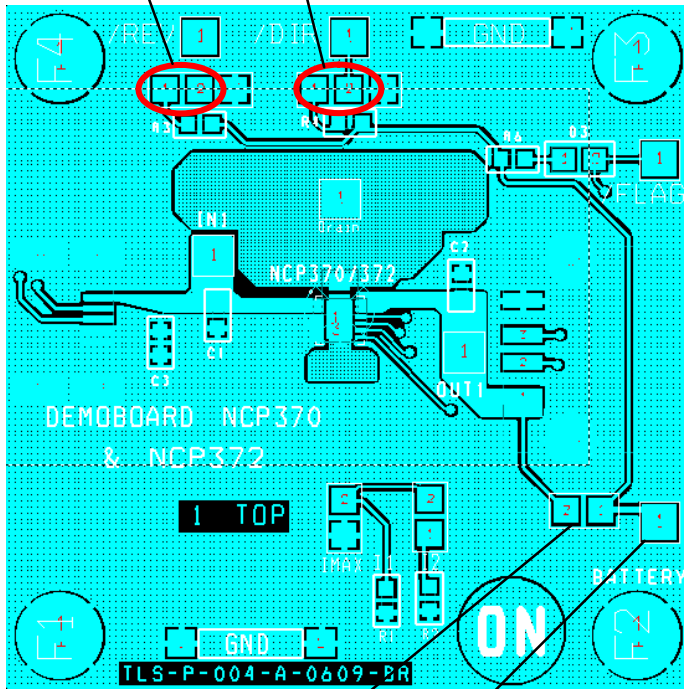

Figure 4. NCP370GEVB Board Layout (Bottom View)

NCP370GEVB

CONNECTING PROCESS

1. Place /REV strap and /DIR strap on left side ("1" logic) (connected to Vbat, through pull up resistor)



2. Let Battery strap opened.
3. Connect a Battery or power supply (4.2 V) on Battery test point (min 2 A capability).

NCP370GEVB

4. Connect strap on lim.

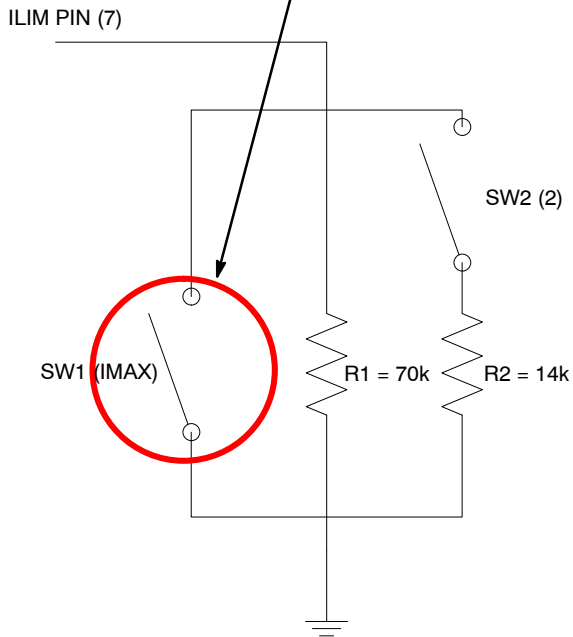
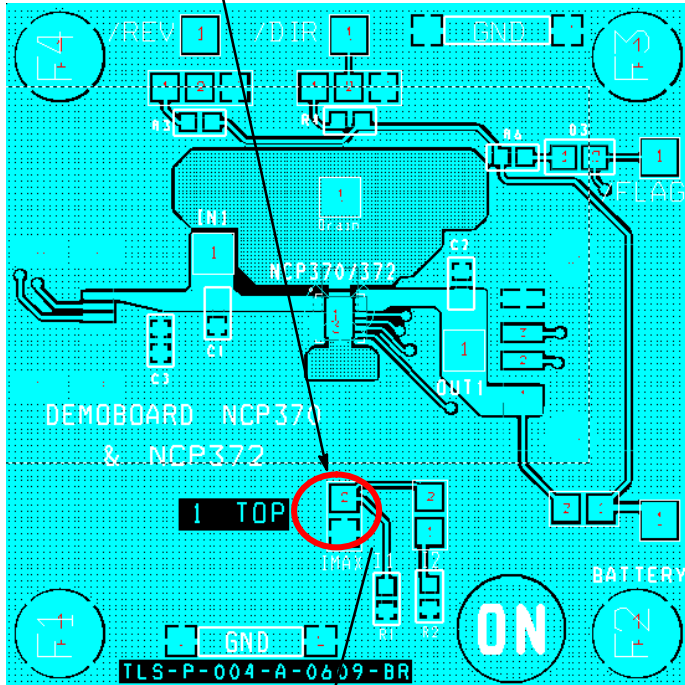

NCP370GEVB

5. Select I limit threshold with pull down resistors connected on pin 7:

SW1	SW2	IOCP
0	0	500 mA
0	1	1 A
1	0	1.5 A
1	1	1.5 A

R1 = 70K

R2 = 14K

Disable Mode:

6. Connect 10 V capability Vin Supply on IN1 test point.

a.) Set power supply to 5 V ⇒ Check Vout = 0 V and LED = off

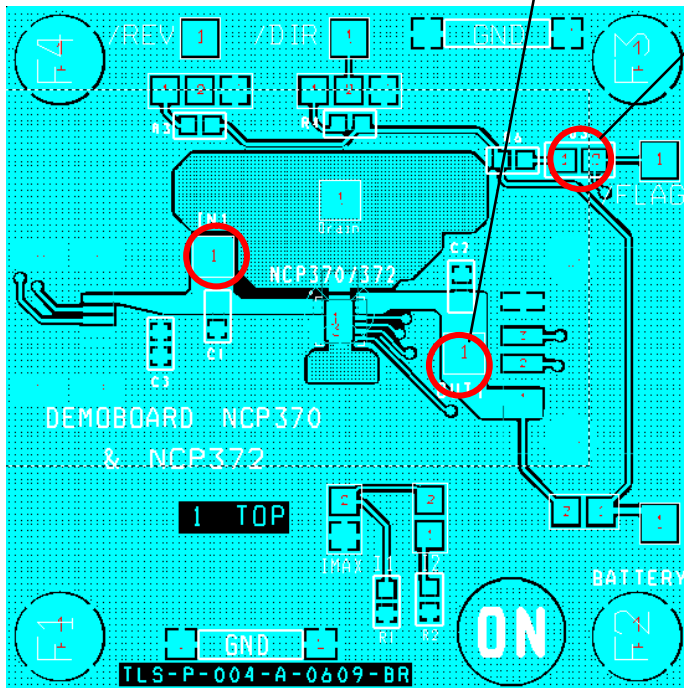

NCP370GEVB

Direct Mode:

7. Switch /DIR from left to right, 1 logic level to 0 logic level

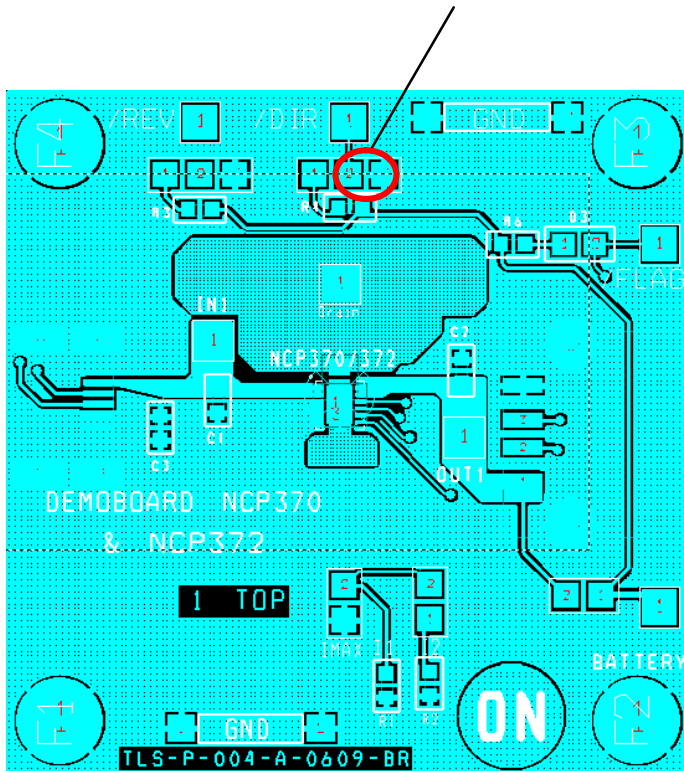

8. Check $V_{out} = 5\text{ V}$ and Flag LED is still off

9. Set $V_{in} = 7\text{ V}$

10. Check Flag LED = on, and V_{out} is 0 V.

11. Switch /REV from left to right, 1 logic level to 0 logic level

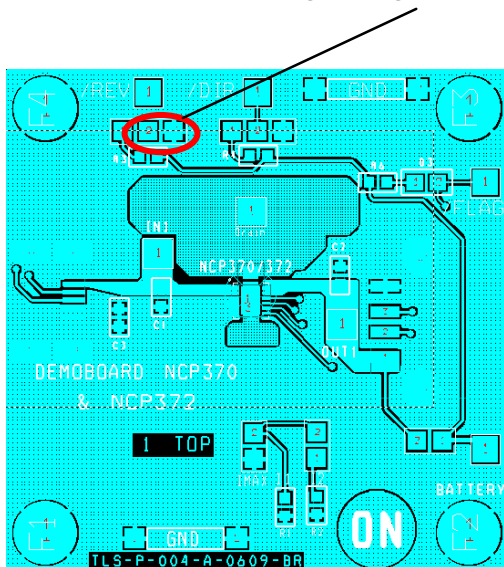

12. Check Flag LED = off, and $V_{out} = V_{in} = 7\text{ V}$.
Disconnect V_{in} Supply.

NCP370GEVB

Reverse Mode:

13. Connect Set /DIR = 1, /REV = 1
Disconnect Vin Power Supply from IN test points.
Connect accessory on IN1 or IN2 test points.

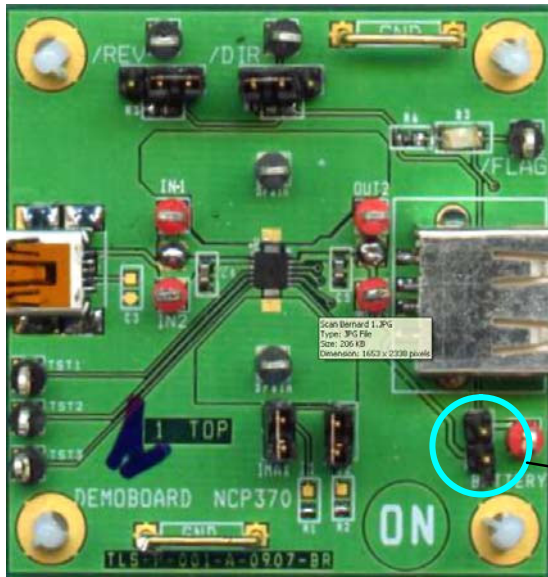

Put strap to connect Battery to Vout

14. Set /DIR = 1, /REV = 0: $V_{out} = V_{in}$

If $I_{accessory} < I_{limit}$ then $V_{in} = V_{out} - R_{dson} \times I$

If $I_{accessory} > I_{limit}$ then $V_{in} = 0$ (Current regulation)

Power off.

15. Set /DIR = 1, /REV = 1
16. Disconnect accessory
17. Disconnect Battery

ON Semiconductor and the ON Semiconductor logo are trademarks of Semiconductor Components Industries, LLC dba ON Semiconductor or its subsidiaries in the United States and/or other countries. ON Semiconductor owns the rights to a number of patents, trademarks, copyrights, trade secrets, and other intellectual property. A listing of ON Semiconductor's product/patent coverage may be accessed at www.onsemi.com/site/pdf/Patent-Marking.pdf. ON Semiconductor is an Equal Opportunity/Affirmative Action Employer. This literature is subject to all applicable copyright laws and is not for resale in any manner.

The evaluation board/kit (research and development board/kit) (hereinafter the "board") is not a finished product and is as such not available for sale to consumers. The board is only intended for research, development, demonstration and evaluation purposes and should as such only be used in laboratory/development areas by persons with an engineering/technical training and familiar with the risks associated with handling electrical/mechanical components, systems and subsystems. This person assumes full responsibility/liability for proper and safe handling. Any other use, resale or redistribution for any other purpose is strictly prohibited.

The board is delivered "AS IS" and without warranty of any kind including, but not limited to, that the board is production-worthy, that the functions contained in the board will meet your requirements, or that the operation of the board will be uninterrupted or error free. ON Semiconductor expressly disclaims all warranties, express, implied or otherwise, including without limitation, warranties of fitness for a particular purpose and non-infringement of intellectual property rights.

ON Semiconductor reserves the right to make changes without further notice to any board.

You are responsible for determining whether the board will be suitable for your intended use or application or will achieve your intended results. Prior to using or distributing any systems that have been evaluated, designed or tested using the board, you agree to test and validate your design to confirm the functionality for your application. Any technical, applications or design information or advice, quality characterization, reliability data or other services provided by ON Semiconductor shall not constitute any representation or warranty by ON Semiconductor, and no additional obligations or liabilities shall arise from ON Semiconductor having provided such information or services.

The boards are not designed, intended, or authorized for use in life support systems, or any FDA Class 3 medical devices or medical devices with a similar or equivalent classification in a foreign jurisdiction, or any devices intended for implantation in the human body. Should you purchase or use the board for any such unintended or unauthorized application, you shall indemnify and hold ON Semiconductor and its officers, employees, subsidiaries, affiliates, and distributors harmless against all claims, costs, damages, and expenses, and reasonable attorney fees arising out of, directly or indirectly, any claim of personal injury or death associated with such unintended or unauthorized use, even if such claim alleges that ON Semiconductor was negligent regarding the design or manufacture of the board.

This evaluation board/kit does not fall within the scope of the European Union directives regarding electromagnetic compatibility, restricted substances (RoHS), recycling (WEEE), FCC, CE or UL, and may not meet the technical requirements of these or other related directives.

FCC WARNING – This evaluation board/kit is intended for use for engineering development, demonstration, or evaluation purposes only and is not considered by ON Semiconductor to be a finished end product fit for general consumer use. It may generate, use, or radiate radio frequency energy and has not been tested for compliance with the limits of computing devices pursuant to part 15 of FCC rules, which are designed to provide reasonable protection against radio frequency interference. Operation of this equipment may cause interference with radio communications, in which case the user shall be responsible, at its expense, to take whatever measures may be required to correct this interference.

ON Semiconductor does not convey any license under its patent rights nor the rights of others.

LIMITATIONS OF LIABILITY: ON Semiconductor shall not be liable for any special, consequential, incidental, indirect or punitive damages, including, but not limited to the costs of requalification, delay, loss of profits or goodwill, arising out of or in connection with the board, even if ON Semiconductor is advised of the possibility of such damages. In no event shall ON Semiconductor's aggregate liability from any obligation arising out of or in connection with the board, under any theory of liability, exceed the purchase price paid for the board, if any.

For more information and documentation, please visit www.onsemi.com.

PUBLICATION ORDERING INFORMATION

LITERATURE FULFILLMENT:

Email Requests to: orderlit@onsemi.com

ON Semiconductor Website: www.onsemi.com

TECHNICAL SUPPORT

North American Technical Support:

Voice Mail: 1 800-282-9855 Toll Free USA/Canada

Phone: 011 421 33 790 2910

Europe, Middle East and Africa Technical Support:

Phone: 00421 33 790 2910

For additional information, please contact your local Sales Representative