

MC74HC374A

Octal 3-State Non-Inverting D Flip-Flop

High-Performance Silicon-Gate CMOS

The MC74HC374A is identical in pinout to the LS374. The device inputs are compatible with standard CMOS outputs; with pullup resistors, they are compatible with LSTTL outputs.

Data meeting the setup time is clocked to the outputs with the rising edge of the clock. The Output Enable input does not affect the states of the flip-flops, but when Output Enable is high, the outputs are forced to the high-impedance state; thus, data may be stored even when the outputs are not enabled.

The HC374A is identical in function to the HC574A which has the input pins on the opposite side of the package from the output. This device is similar in function to the HC534A which has inverting outputs.

Features

- Output Drive Capability: 15 LSTTL Loads
- Outputs Directly Interface to CMOS, NMOS, and TTL
- Operating Voltage Range: 2.0 to 6.0 V
- Low Input Current: 1.0 μ A
- High Noise Immunity Characteristic of CMOS Devices
- In Compliance with the Requirements Defined by JEDEC Standard No. 7A
- Chip Complexity: 266 FETs or 66.5 Equivalent Gates
- Pb-Free Packages are Available*



ON Semiconductor®

<http://onsemi.com>

MARKING DIAGRAMS

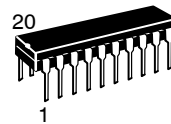

PDIP-20
N SUFFIX
CASE 738

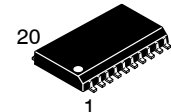
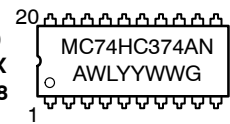

SOIC-20
DW SUFFIX
CASE 751D

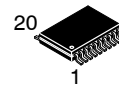
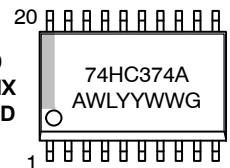

TSSOP-20
DT SUFFIX
CASE 948E

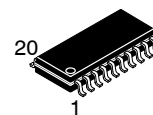
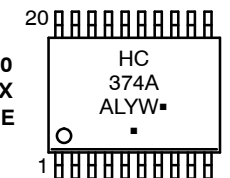

SOEIAJ-20
F SUFFIX
CASE 967



A = Assembly Location
WL, L = Wafer Lot
YY, Y = Year
WW, W = Work Week
G or ▪ = Pb-Free Package
(Note: Microdot may be in either location)

ORDERING INFORMATION

See detailed ordering and shipping information in the package dimensions section on page 2 of this data sheet.

*For additional information on our Pb-Free strategy and soldering details, please download the ON Semiconductor Soldering and Mounting Techniques Reference Manual, SOLDERRM/D.

MC74HC374A

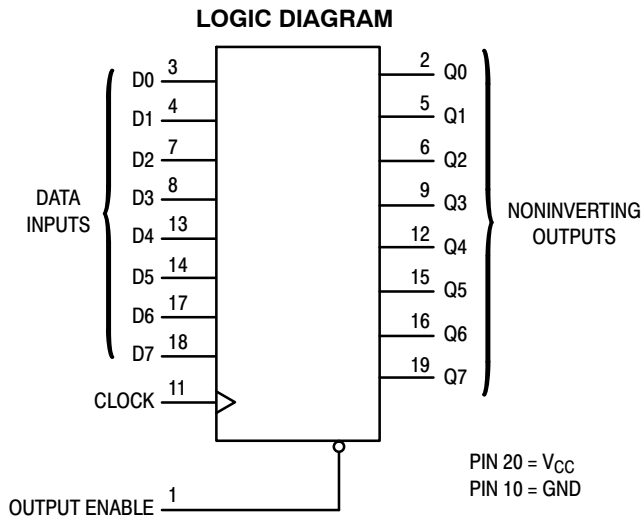

PIN ASSIGNMENT

OUTPUT ENABLE	1 ●	20	V _{CC}
Q0	2	19	Q7
D0	3	18	D7
D1	4	17	D6
Q1	5	16	Q6
Q2	6	15	Q5
D2	7	14	D5
D3	8	13	D4
Q3	9	12	Q4
GND	10	11	CLOCK

FUNCTION TABLE

Output Enable	Inputs		Output
	Clock	D	Q
L		H	H
L		L	L
L	L, H,	X	No Change
H	X	X	Z

X = don't care

Z = high impedance

ORDERING INFORMATION

Device	Package	Shipping†
MC74HC374AN	PDIP-20	18 Units / Box
MC74HC374ANG	PDIP-20 (Pb-Free)	18 Units / Box
MC74HC374ADW	SOIC-20 WIDE	38 Units / Rail
MC74HC374ADWG	SOIC-20 WIDE (Pb-Free)	38 Units / Rail
MC74HC374ADWR2	SOIC-20 WIDE	1000 Tape & Reel
MC74HC374ADWR2G	SOIC-20 WIDE (Pb-Free)	1000 Tape & Reel
MC74HC374ADT	TSSOP-20*	75 Units / Rail
MC74HC374ADTG	TSSOP-20*	75 Units / Rail
MC74HC374ADTR2	TSSOP-20*	2500 Tape & Reel
MC74HC374ADTR2G	TSSOP-20*	2500 Tape & Reel
MC74HC374AFG	SOEIAJ-20 (Pb-Free)	40 Units / Rail
MC74HC374AFELG	SOEIAJ-20 (Pb-Free)	2000 Tape & Reel

†For information on tape and reel specifications, including part orientation and tape sizes, please refer to our Tape and Reel Packaging Specifications Brochure, BRD8011/D.

*This package is inherently Pb-Free.

MC74HC374A

MAXIMUM RATINGS

Symbol	Parameter	Value	Unit
V_{CC}	DC Supply Voltage (Referenced to GND)	- 0.5 to + 7.0	V
V_{in}	DC Input Voltage (Referenced to GND)	- 0.5 to $V_{CC} + 0.5$	V
V_{out}	DC Output Voltage (Referenced to GND)	- 0.5 to $V_{CC} + 0.5$	V
I_{in}	DC Input Current, per Pin	± 20	mA
I_{out}	DC Output Current, per Pin	± 35	mA
I_{CC}	DC Supply Current, V_{CC} and GND Pins	± 75	mA
P_D	Power Dissipation in Still Air, Plastic DIP† SOIC Package† TSSOP Package†	750 500 450	mW
T_{stg}	Storage Temperature	- 65 to + 150	°C
T_L	Lead Temperature, 1 mm from Case for 10 Seconds (Plastic DIP, SOIC, SSOP or TSSOP Package)	260	°C

This device contains protection circuitry to guard against damage due to high static voltages or electric fields. However, precautions must be taken to avoid applications of any voltage higher than maximum rated voltages to this high-impedance circuit. For proper operation, V_{in} and V_{out} should be constrained to the range $GND \leq (V_{in} \text{ or } V_{out}) \leq V_{CC}$. Unused inputs must always be tied to an appropriate logic voltage level (e.g., either GND or V_{CC}). Unused outputs must be left open.

Stresses exceeding Maximum Ratings may damage the device. Maximum Ratings are stress ratings only. Functional operation above the Recommended Operating Conditions is not implied. Extended exposure to stresses above the Recommended Operating Conditions may affect device reliability.

†Derating — Plastic DIP: - 10 mW/°C from 65° to 125°C
SOIC Package: - 7 mW/°C from 65° to 125°C
TSSOP Package: - 6.1 mW/°C from 65° to 125°C

For high frequency or heavy load considerations, see Chapter 2 of the ON Semiconductor High-Speed CMOS Data Book (DL129/D).

RECOMMENDED OPERATING CONDITIONS

Symbol	Parameter	Min	Max	Unit
V_{CC}	DC Supply Voltage (Referenced to GND)	2.0	6.0	V
V_{in}, V_{out}	DC Input Voltage, Output Voltage (Referenced to GND)	0	V_{CC}	V
T_A	Operating Temperature, All Package Types	- 55	+ 125	°C
t_r, t_f	Input Rise and Fall Time (Figure 1)	$V_{CC} = 2.0 \text{ V}$ $V_{CC} = 4.5 \text{ V}$ $V_{CC} = 6.0 \text{ V}$	0 1000 500 400	ns

DC ELECTRICAL CHARACTERISTICS (Voltages Referenced to GND)

Symbol	Parameter	Test Conditions	V_{CC} V	Guaranteed Limit			Unit	
				- 55 to 25°C	≤ 85°C	≤ 125°C		
V_{IH}	Minimum High-Level Input Voltage	$V_{out} = 0.1 \text{ V or } V_{CC} - 0.1 \text{ V}$ $ I_{out} \leq 20 \mu\text{A}$	2.0	1.50	1.50	1.50	V	
			3.0	2.10	2.10	2.10		
			4.5	3.15	3.15	3.15		
			6.0	4.20	4.20	4.20		
V_{IL}	Maximum Low-Level Input Voltage	$V_{out} = 0.1 \text{ V or } V_{CC} - 0.1 \text{ V}$ $ I_{out} \leq 20 \mu\text{A}$	2.0	0.50	0.50	0.50	V	
			3.0	0.90	0.90	0.90		
			4.5	1.35	1.35	1.35		
			6.0	1.80	1.80	1.80		
V_{OH}	Minimum High-Level Output Voltage	$V_{in} = V_{IH} \text{ or } V_{IL}$ $ I_{out} \leq 20 \mu\text{A}$	2.0	1.90	1.90	1.90	V	
			4.5	4.40	4.40	4.40		
			6.0	5.90	5.90	5.90		
		$V_{in} = V_{IH} \text{ or } V_{IL}$	$ I_{out} \leq 2.4 \text{ mA}$	3.0	2.48	2.34	2.20	V
			$ I_{out} \leq 6.0 \text{ mA}$	4.5	2.98	3.84	3.70	
			$ I_{out} \leq 7.8 \text{ mA}$	6.0	5.48	5.34	5.20	
V_{OL}	Maximum Low-Level Output Voltage	$V_{in} = V_{IH} \text{ or } V_{IL}$ $ I_{out} \leq 20 \mu\text{A}$	2.0	0.10	0.10	0.10	V	
			4.5	0.10	0.10	0.10		
			6.0	0.10	0.10	0.10		
		$V_{in} = V_{IH} \text{ or } V_{IL}$	$ I_{out} \leq 2.4 \text{ mA}$	3.0	0.26	0.33	0.40	V
			$ I_{out} \leq 6.0 \text{ mA}$	4.5	0.26	0.33	0.40	
			$ I_{out} \leq 7.8 \text{ mA}$	6.0	0.26	0.33	0.40	

MC74HC374A

DC ELECTRICAL CHARACTERISTICS (Voltages Referenced to GND)

Symbol	Parameter	Test Conditions	V _{CC} V	Guaranteed Limit			Unit
				- 55 to 25°C	≤ 85°C	≤ 125°C	
I _{in}	Maximum Input Leakage Current	V _{in} = V _{CC} or GND	6.0	± 0.1	± 1.0	± 1.0	μA
I _{oz}	Maximum Three-State Leakage Current	Output in High-Impedance State V _{in} = V _{IL} or V _{IH} V _{out} = V _{CC} or GND	6.0	± 0.5	± 5.0	± 10	μA
I _{CC}	Maximum Quiescent Supply Current (per Package)	V _{in} = V _{CC} or GND I _{out} = 0 μA	6.0	4	40	160	μA

NOTE: Information on typical parametric values can be found in Chapter 2 of the ON Semiconductor High-Speed CMOS Data Book (DL129/D).

AC ELECTRICAL CHARACTERISTICS (C_L = 50 pF, Input t_r = t_f = 6.0 ns)

Symbol	Parameter	V _{CC} V	Guaranteed Limit			Unit
			- 55 to 25°C	≤ 85°C	≤ 125°C	
f _{max}	Maximum Clock Frequency (50% Duty Cycle)	2.0	6	5	4	MHz
		3.0	15	10	8	
		4.5	30	24	20	
		6.0	35	28	24	
t _{PLH} t _{PHL}	Maximum Propagation Delay, Input Clock to Q (Figures 1 and 5)	2.0	125	155	190	ns
		3.0	80	110	130	
		4.5	25	31	38	
		6.0	21	26	32	
t _{PLZ} t _{PHZ}	Maximum Propagation Delay, Output Enable to Q (Figures 3 and 6)	2.0	150	190	225	ns
		3.0	100	125	150	
		4.5	30	38	45	
		6.0	26	33	38	
t _{PZL} t _{PZH}	Maximum Propagation Delay, Output Enable to Q (Figures 3 and 6)	2.0	150	190	225	ns
		3.0	100	125	150	
		4.5	30	38	45	
		6.0	26	33	38	
t _{TLH} t _{THL}	Maximum Output Transition Time, Any Output (Figures 1 and 5)	2.0	75	95	110	ns
		3.0	27	32	36	
		4.5	15	19	22	
		6.0	13	16	19	
C _{in}	Maximum Input Capacitance		10	10	10	pF
C _{out}	Maximum Three-State Output Capacitance (Output in High-Impedance State)		15	15	15	pF

NOTE: For propagation delays with loads other than 50 pF, and information on typical parametric values, see Chapter 2 of the ON Semiconductor High-Speed CMOS Data Book (DL129/D).

C _{PD}	Power Dissipation Capacitance (Per Enabled Output)*	Typical @ 25°C, V _{CC} = 5.0 V	
			34

* Used to determine the no-load dynamic power consumption: P_D = C_{PD} V_{CC}²f + I_{CC} V_{CC}. For load considerations, see Chapter 2 of the ON Semiconductor High-Speed CMOS Data Book (DL129/D).

MC74HC374A

TIMING REQUIREMENTS ($C_L = 50$ pF, Input $t_r = t_f = 6.0$ ns)

Symbol	Parameter	Figure	V _{CC} Volts	Guaranteed Limit						Unit
				- 55 to 25 °C		≤ 85 °C		≤ 125 °C		
				Min	Max	Min	Max	Min	Max	
t _{su}	Minimum Setup Time, Data to Clock	3	2.0	50		65		75		ns
			3.0	40		50		60		
			4.5	10		13		15		
			6.0	9		11		13		
t _h	Minimum Hold Time, Clock to Data	3	2.0	5.0		5.0		5.0		ns
			3.0	5.0		5.0		5.0		
			4.5	5.0		5.0		5.0		
			6.0	5.0		5.0		5.0		
t _w	Minimum Pulse Width, Clock	1	2.0	60		75		90		ns
			3.0	23		27		32		
			4.5	12		15		18		
			6.0	10		13		15		
t _r , t _f	Maximum Input Rise and Fall Times	1	2.0		1000		1000		1000	ns
			3.0		800		800		800	
			4.5		500		500		500	
			6.0		400		400		400	

SWITCHING WAVEFORMS

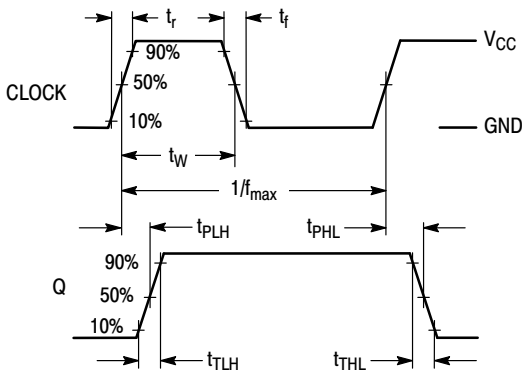

Figure 1.

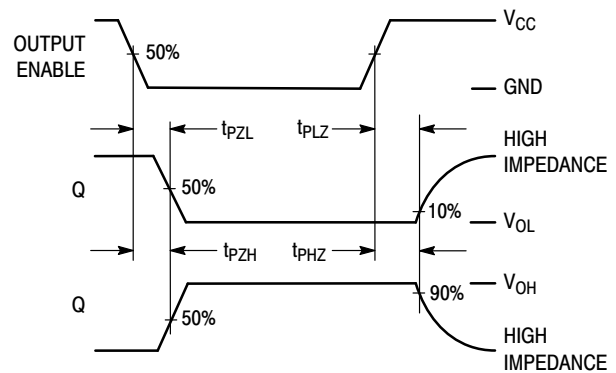

Figure 2.

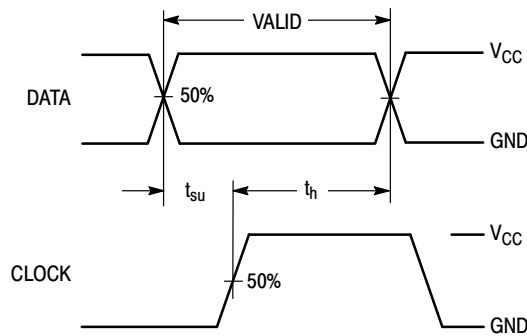
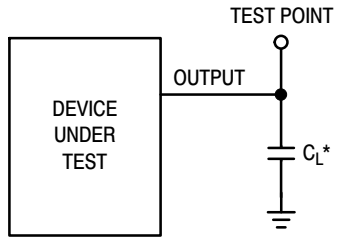

Figure 3.

MC74HC374A

TEST CIRCUITS



*Includes all probe and jig capacitance

Figure 4.

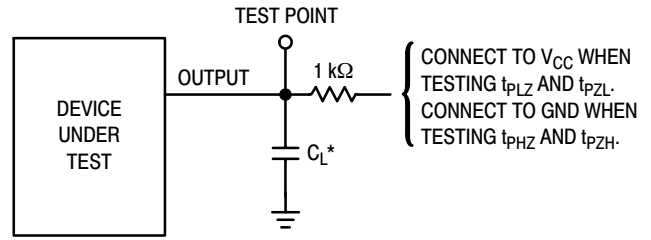

*Includes all probe and jig capacitance

Figure 5.

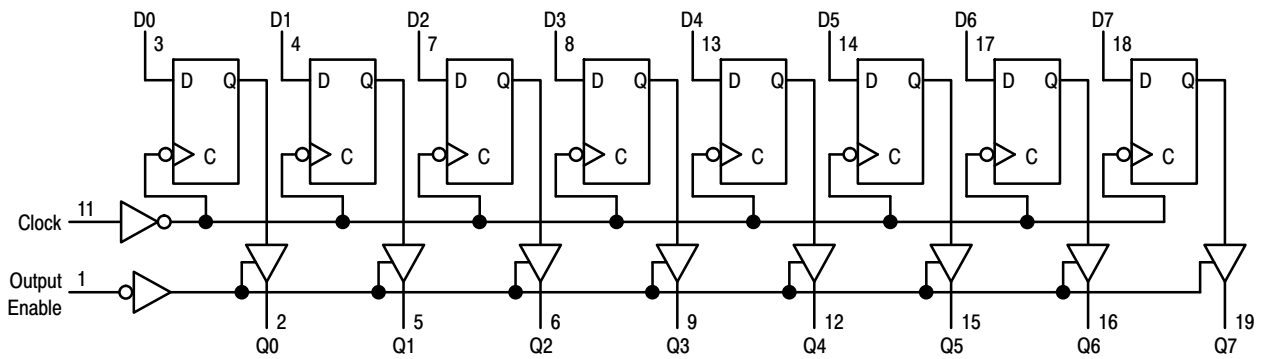
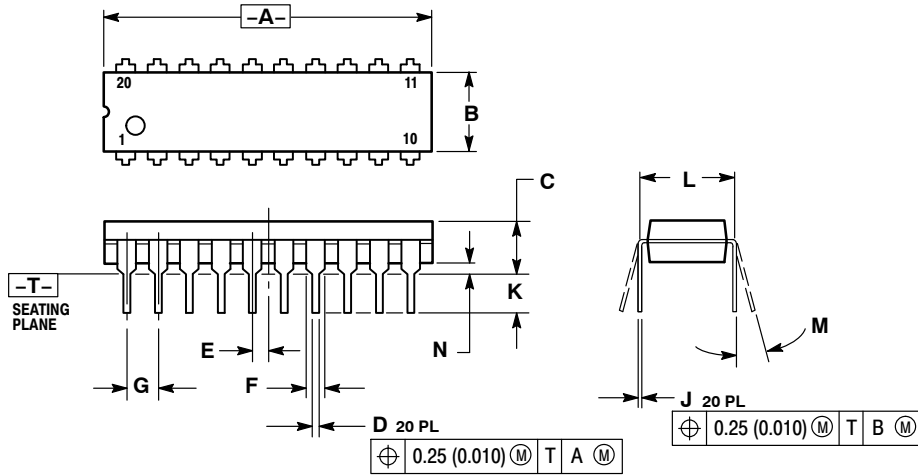

Figure 6. Expanded Logic Diagram

MC74HC374A

PACKAGE DIMENSIONS

PDIP-20
N SUFFIX
PLASTIC DIP PACKAGE
CASE 738-03
ISSUE E



NOTES:

1. DIMENSIONING AND TOLERANCING PER ANSI Y14.5M, 1982.
2. CONTROLLING DIMENSION: INCH.
3. DIMENSION L TO CENTER OF LEAD WHEN FORMED PARALLEL.
4. DIMENSION B DOES NOT INCLUDE MOLD FLASH.

DIM	INCHES		MILLIMETERS	
	MIN	MAX	MIN	MAX
A	1.010	1.070	25.66	27.17
B	0.240	0.260	6.10	6.60
C	0.150	0.180	3.81	4.57
D	0.015	0.022	0.39	0.55
E	0.050 BSC		1.27 BSC	
F	0.050	0.070	1.27	1.77
G	0.100 BSC		2.54 BSC	
J	0.008	0.015	0.21	0.38
K	0.110	0.140	2.80	3.55
L	0.300 BSC		7.62 BSC	
M	0°	15°	0°	15°
N	0.020	0.040	0.51	1.01

SOIC-20
DW SUFFIX
CASE 751D-05
ISSUE G

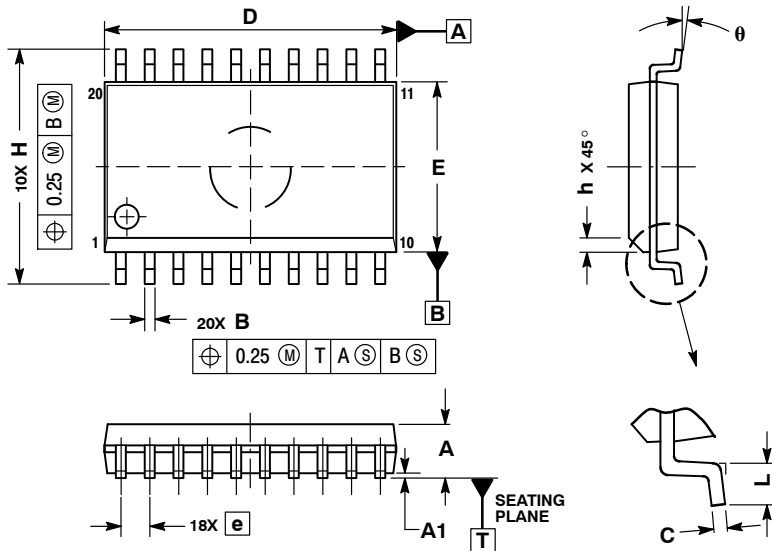

NOTES:

1. DIMENSIONS ARE IN MILLIMETERS.
2. INTERPRET DIMENSIONS AND TOLERANCES PER ASME Y14.5M, 1994.
3. DIMENSIONS D AND E DO NOT INCLUDE MOLD PROTRUSION.
4. MAXIMUM MOLD PROTRUSION 0.15 PER SIDE.
5. DIMENSION B DOES NOT INCLUDE DAMBAR PROTRUSION. ALLOWABLE PROTRUSION SHALL BE 0.13 TOTAL IN EXCESS OF B DIMENSION AT MAXIMUM MATERIAL CONDITION.

DIM	MILLIMETERS	
	MIN	MAX
A	2.35	2.65
A1	0.10	0.25
B	0.35	0.49
C	0.23	0.32
D	12.65	12.95
E	7.40	7.60
e	1.27 BSC	
H	10.05	10.55
h	0.25	0.75
L	0.50	0.90
theta	0°	7°

MC74HC374A

PACKAGE DIMENSIONS

TSSOP-20
DT SUFFIX
CASE 948E-02
ISSUE C

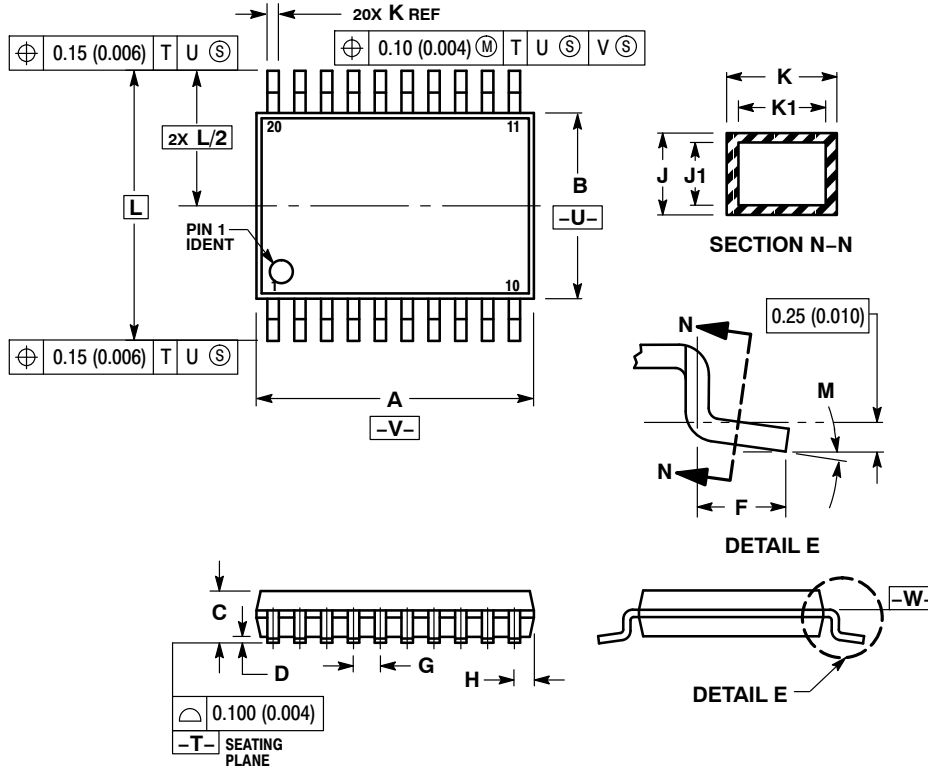

NOTES:

1. DIMENSIONING AND TOLERANCING PER ANSI Y14.5M, 1982.
2. CONTROLLING DIMENSION: MILLIMETER.
3. DIMENSION A DOES NOT INCLUDE MOLD FLASH, PROTRUSIONS OR GATE BURRS. MOLD FLASH OR GATE BURRS SHALL NOT EXCEED 0.15 (0.006) PER SIDE.
4. DIMENSION B DOES NOT INCLUDE INTERLEAD FLASH OR PROTRUSION. INTERLEAD FLASH OR PROTRUSION SHALL NOT EXCEED 0.25 (0.010) PER SIDE.
5. DIMENSION K DOES NOT INCLUDE DAMBAR PROTRUSION. ALLOWABLE DAMBAR PROTRUSION SHALL BE 0.08 (0.003) TOTAL IN EXCESS OF THE K DIMENSION AT MAXIMUM MATERIAL CONDITION.
6. TERMINAL NUMBERS ARE SHOWN FOR REFERENCE ONLY.
7. DIMENSION A AND B ARE TO BE DETERMINED AT DATUM PLANE -W-.

DIM	MILLIMETERS		INCHES	
	MIN	MAX	MIN	MAX
A	6.40	6.60	0.252	0.260
B	4.30	4.50	0.169	0.177
C	---	1.20	---	0.047
D	0.05	0.15	0.002	0.006
F	0.50	0.75	0.020	0.030
G	0.65 BSC		0.026 BSC	
H	0.27	0.37	0.011	0.015
J	0.09	0.20	0.004	0.008
J1	0.09	0.16	0.004	0.006
K	0.19	0.30	0.007	0.012
K1	0.19	0.25	0.007	0.010
L	6.40 BSC		0.252 BSC	
M	0°	8°	0°	8°

SOLDERING FOOTPRINT

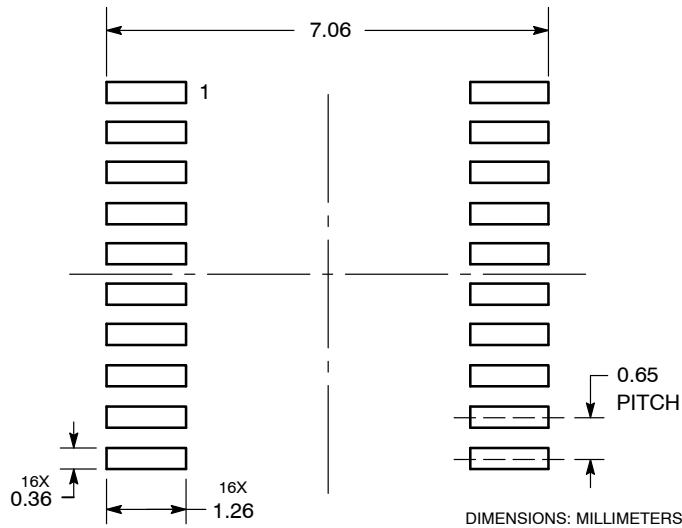

MC74HC374A

PACKAGE DIMENSIONS

SOEIAJ-20
F SUFFIX
CASE 967-01
ISSUE A

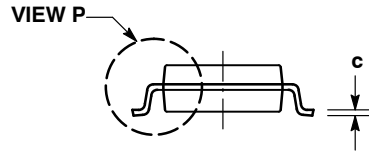
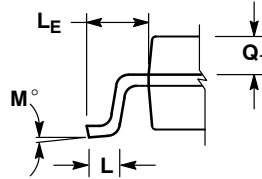
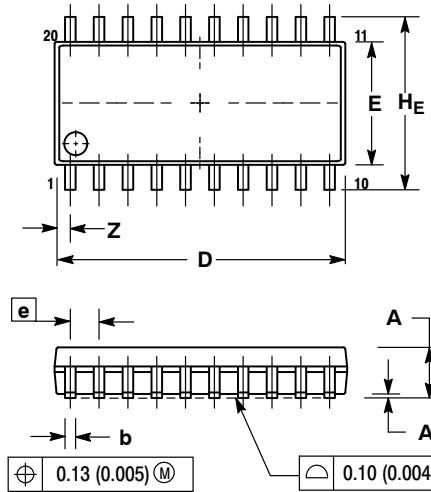

NOTES:

1. DIMENSIONING AND TOLERANCING PER ANSI Y14.5M, 1982.
2. CONTROLLING DIMENSION: MILLIMETER.
3. DIMENSIONS D AND E DO NOT INCLUDE MOLD FLASH OR PROTRUSIONS AND ARE MEASURED AT THE PARTING LINE. MOLD FLASH OR PROTRUSIONS SHALL NOT EXCEED 0.15 (0.006) PER SIDE.
4. TERMINAL NUMBERS ARE SHOWN FOR REFERENCE ONLY.
5. THE LEAD WIDTH DIMENSION (b) DOES NOT INCLUDE DAMBAR PROTRUSION. ALLOWABLE DAMBAR PROTRUSION SHALL BE 0.08 (0.003) TOTAL IN EXCESS OF THE LEAD WIDTH DIMENSION AT MAXIMUM MATERIAL CONDITION. DAMBAR CANNOT BE LOCATED ON THE LOWER RADIUS OR THE FOOT. MINIMUM SPACE BETWEEN PROTRUSIONS AND ADJACENT LEAD TO BE 0.46 (0.018).

DIM	MILLIMETERS		INCHES	
	MIN	MAX	MIN	MAX
A	---	2.05	---	0.081
A ₁	0.05	0.20	0.002	0.008
b	0.35	0.50	0.014	0.020
c	0.15	0.25	0.006	0.010
D	12.35	12.90	0.486	0.504
E	5.10	5.45	0.201	0.215
e	1.27 BSC		0.050 BSC	
H _E	7.40	8.20	0.291	0.323
L	0.50	0.85	0.020	0.033
L _E	1.10	1.50	0.043	0.059
M	0 °	10 °	0 °	10 °
Q ₁	0.70	0.90	0.028	0.035
Z	---	0.81	---	0.032

ON Semiconductor and are registered trademarks of Semiconductor Components Industries, LLC (SCILLC). SCILLC reserves the right to make changes without further notice to any products herein. SCILLC makes no warranty, representation or guarantee regarding the suitability of its products for any particular purpose, nor does SCILLC assume any liability arising out of the application or use of any product or circuit, and specifically disclaims any and all liability, including without limitation special, consequential or incidental damages. "Typical" parameters which may be provided in SCILLC data sheets and/or specifications can and do vary in different applications and actual performance may vary over time. All operating parameters, including "Typicals" must be validated for each customer application by customer's technical experts. SCILLC does not convey any license under its patent rights nor the rights of others. SCILLC products are not designed, intended, or authorized for use as components in systems intended for surgical implant into the body, or other applications intended to support or sustain life, or for any other application in which the failure of the SCILLC product could create a situation where personal injury or death may occur. Should Buyer purchase or use SCILLC products for any such unintended or unauthorized application, Buyer shall indemnify and hold SCILLC and its officers, employees, subsidiaries, affiliates, and distributors harmless against all claims, costs, damages, and expenses, and reasonable attorney fees arising out of, directly or indirectly, any claim of personal injury or death associated with such unintended or unauthorized use, even if such claim alleges that SCILLC was negligent regarding the design or manufacture of the part. SCILLC is an Equal Opportunity/Affirmative Action Employer. This literature is subject to all applicable copyright laws and is not for resale in any manner.

PUBLICATION ORDERING INFORMATION

LITERATURE FULFILLMENT:
Literature Distribution Center for ON Semiconductor
P.O. Box 5163, Denver, Colorado 80217 USA
Phone: 303-675-2175 or 800-344-3860 Toll Free USA/Canada
Fax: 303-675-2176 or 800-344-3867 Toll Free USA/Canada
Email: orderlit@onsemi.com

N. American Technical Support: 800-282-9855 Toll Free
USA/Canada
Europe, Middle East and Africa Technical Support:
Phone: 421 33 790 2910
Japan Customer Focus Center
Phone: 81-3-5773-3850

ON Semiconductor Website: www.onsemi.com

Order Literature: <http://www.onsemi.com/orderlit>

For additional information, please contact your local Sales Representative

MC74HC374A/D