

TinyLogic UHS Dual Buffer (Open-Drain Outputs)

NC7WZ07

Description

The NC7WZ07 is a dual buffer with open-drain outputs from onsemi's Ultra-High Speed (UHS) series of TinyLogic. The device is fabricated with advanced CMOS technology to achieve ultra-high speed with high output drive, while maintaining low static power dissipation over a broad V_{CC} operating range. The device is specified to operate over a very broad V_{CC} operating range. The device is specified to operate over the 1.65 V to 5.5 V V_{CC} range. The inputs and outputs are high impedance when V_{CC} is 0 V. Inputs tolerate voltages up to 5.5 V independent of V_{CC} operating voltage.

Features

- Ultra-High Speed: $t_{PZL} = 2.3$ ns (Typical)
- High I_{OL} Output Drive: ± 24 mA at 3 V V_{CC}
- Broad V_{CC} Operating Range: 1.65 V to 5.50 V
- Power Down High-Impedance Inputs / Outputs
- Over-Voltage Tolerance Inputs Facilitate 5 V to 3 V Translation
- Proprietary Noise / EMI Reduction Circuitry
- Ultra-Small MicroPak™ Packages
- These Devices are Pb-Free, Halogen Free/BFR Free and are RoHS Compliant

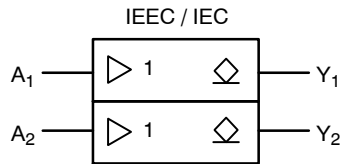
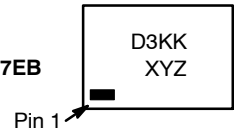

Figure 1. Logic Symbol

MARKING DIAGRAMS



SIP6
CASE 127EB



UDFN6
CASE 517DP

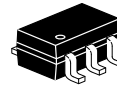
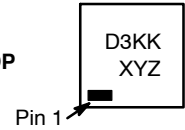

SC-88
CASE 419B-02

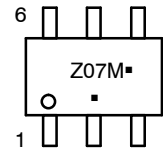

D3, Z07 = Specific Device Code
KK = 2-Digit Lot Run Traceability Code
XY = 2-Digit Date Code Format
Z = Assembly Plant Code
M = Date Code*
▪ = Pb-Free Package

(Note: Microdot may be in either location)

*Date Code orientation and/or position may vary depending upon manufacturing location.

ORDERING INFORMATION

See detailed ordering, marking and shipping information in the package dimensions section on page 5 of this data sheet.

NC7WZ07

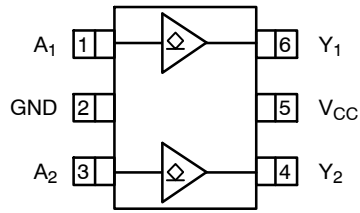

Figure 2. SC-88 (Top View)

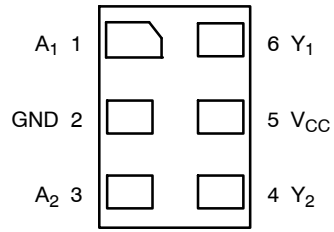
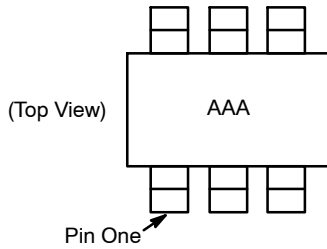

Figure 3. MicroPak (Top Through View)



NOTES:

1. AAA represents product code top mark (see Ordering Information).
2. Orientation of top mark determines pin one location.
3. Read the top mark left to right, pin one is the lower left pin.

Figure 4. Pin 1 Orientation

PIN DEFINITIONS

Pin # SC-88	Pin # MicroPak	Name	Description
1	1	A ₁	Input
2	2	GND	Ground
3	3	A ₂	Input
4	4	Y ₂	Output
5	5	V _{CC}	Supply Voltage
6	6	Y ₁	Output

FUNCTION TABLE (Y = A)

Inputs	Output
A	Y
LOW Logic Level	LOW Logic Level
HIGH Logic Level	HIGH Impedance Output State, Open Drain

NC7WZ07

ABSOLUTE MAXIMUM RATINGS

Symbol	Parameter		Min	Max	Unit
V _{CC}	Supply Voltage		-0.5	6.5	V
V _{IN}	DC Input Voltage		-0.5	6.5	V
V _{OUT}	DC Output Voltage		-0.5	6.5	V
I _{IK}	DC Input Diode Current	V _{IN} < 0 V	-	-50	mA
I _{OK}	DC Output Diode Current	V _{OUT} < 0 V	-	-50	mA
I _{OUT}	DC Output Current		-	±50	mA
I _{CC} or I _{GND}	DC V _{CC} or Ground Current		-	±100	mA
T _{STG}	Storage Temperature Range		-65	+150	°C
T _J	Junction Temperature Under Bias		-	+150	°C
T _L	Junction Lead Temperature (Soldering, 10 Seconds)		-	+260	°C
P _D	Power Dissipation in Still Air	SC-88	-	332	mW
		MicroPak-6	-	812	
		MicroPak2™-6	-	812	
ESD	Human Body Model, JEDEC: JESD22-A114		-	4000	V
	Charge Device Model, JEDEC: JESD22-C101		-	2000	

Stresses exceeding those listed in the Maximum Ratings table may damage the device. If any of these limits are exceeded, device functionality should not be assumed, damage may occur and reliability may be affected.

RECOMMENDED OPERATING CONDITIONS

Symbol	Parameter	Conditions	Min	Max	Unit
V _{CC}	Supply Voltage Operating		1.65	5.5	V
	Supply Voltage Data Retention		1.5	5.5	
V _{IN}	Input Voltage		0	5.5	V
V _{OUT}	Output Voltage		0	5.5	V
t _r , t _f	Input Rise and Fall Times	V _{CC} at 1.8 V ±0.15 V, 2.5 V ±0.2 V	0	20	ns/V
		V _{CC} at 3.3 V ±0.3 V	0	10	
		V _{CC} at 5.0 V ±0.5 V	0	5	
T _A	Operating Temperature		-40	+85	°C
θ _{JA}	Thermal Resistance	SC-88-6	-	377	°C/W
		MicroPak-6	-	154	
		MicroPak2-6	-	154	

Functional operation above the stresses listed in the Recommended Operating Ranges is not implied. Extended exposure to stresses beyond the Recommended Operating Ranges limits may affect device reliability.

4. Unused inputs must be held HIGH or LOW. They may not float.

NC7WZ07

DC ELECTRICAL CHARACTERISTICS

Symbol	Parameter	V _{CC} (V)	Conditions	T _A = +25°C			T _A = -40 to +85°C		Unit	
				Min	Typ	Max	Min	Max		
V _{IH}	HIGH Level Input Voltage	1.65 to 1.95		0.65 V _{CC}	-	-	0.65 V _{CC}	-	V	
		2.30 to 5.50		0.70 V _{CC}	-	-	0.70 V _{CC}	-		
V _{IL}	LOW Level Input Voltage	1.65 to 1.95		-	-	0.35 V _{CC}	-	0.35 V _{CC}	V	
		2.30 to 5.50		-	-	0.30 V _{CC}	-	0.30 V _{CC}		
I _{LKG}	HIGH Level Output Leakage Current	1.65 to 1.95	V _{IN} = V _{IH} or V _{IL} , V _{OUT} = V _{CC} or GND	-	-	±5	-	±10	µA	
V _{OL}	LOW Level Output Voltage	1.65	V _{IN} = V _{IH} or V _{IL} , I _{OL} = 100 µA	-	0.00	0.10	-	0.00	V	
		1.80		-	0.00	0.10	-	0.10		
		2.30		-	0.00	0.10	-	0.10		
		3.00		-	0.00	0.10	-	0.10		
		4.50		-	0.00	0.10	-	0.10		
		1.65	I _{OL} = 4 mA	-	0.80	0.24	-	0.24		
		2.30		I _{OL} = 8 mA	-	0.10	0.30	-		0.30
		3.00			I _{OL} = 16 mA	-	0.16	0.40		-
		3.00		I _{OL} = 24 mA		-	0.24	0.55		-
		4.50			I _{OL} = 32 mA	-	0.25	0.55		-
I _{IN}	Input Leakage Current	1.65 to 5.5	0 ≤ V _{IN} ≤ 5.5 V	-	-	±0.1	-	±1.0	µA	
I _{OFF}	Power Off Leakage Current	0	V _{IN} or V _{OUT} = 5.5 V	-	-	1	-	10	µA	
I _{CC}	Quiescent Supply Current	1.65 to 5.50	V _{IN} = 5.5 V, GND	-	-	1	-	10	µA	

AC ELECTRICAL CHARACTERISTICS

Symbol	Parameter	V _{CC} (V)	Conditions	T _A = +25°C			T _A = -40 to +85°C		Unit
				Min	Typ	Max	Min	Max	
t _{PZL}	Propagation Delay (Figure 5, 6)	1.65	C _L = 50 pF, R _U = 500 Ω, R _D = 500 Ω, V _I = 2 × V _{CC}	-	6.6	11.5	-	12.6	ns
		1.80		-	5.5	9.5	-	10.5	
		2.50 ±0.20		-	3.7	5.8	-	6.4	
		3.30 ±0.30		-	2.9	4.4	-	4.8	
		5.00 ±0.50		-	2.3	3.5	-	3.9	
t _{PLZ}		1.65	C _L = 50 pF, R _U = 500 Ω, R _D = 500 Ω, V _I = 2 × V _{CC}	-	5.5	11.5	-	12.6	
		1.80		-	4.3	9.5	-	10.5	
		2.50 ±0.20		-	2.8	5.8	-	6.4	
		3.30 ±0.30		-	2.1	4.4	-	4.8	
		5.00 ±0.50		-	1.4	3.5	-	3.9	
C _{IN}	Input Capacitance	0		-	2.5	-	-	-	pF
C _{OUT}	Output Capacitance	0		-	4.0	-	-	-	pF
C _{PD}	Power Dissipation Capacitance (Note 5) (Figure 7)	3.30		-	3	-	-	-	pF
		5.00		-	4	-	-	-	

5. C_{PD} is defined as the value of the internal equivalent capacitance which is derived from dynamic operating current consumption (I_{CCD}) at no output loading and operating at 50% duty cycle. C_{PD} is related to I_{CCD} dynamic operating current by the expression:
I_{CCD} = (C_{PD}) (V_{CC}) (f_{IN}) + (I_{CC}static).

NC7WZ07

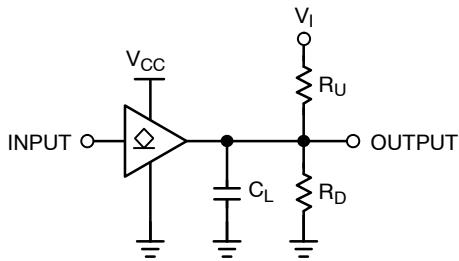

- NOTE:
 6. C_L includes load and stray capacitance.
 7. Input PRR = 1.0 MHz, t_W = 500 ns.

Figure 5. AC Test Circuit

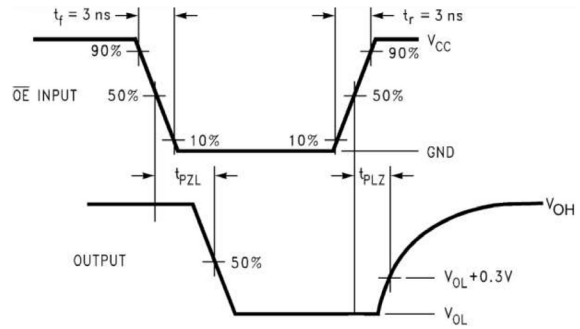
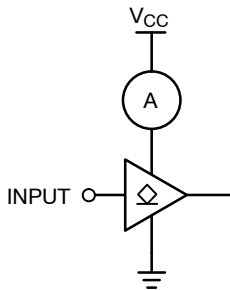

Figure 6. AC Waveforms



- NOTE:
 8. Input = AC Waveform; $t_r = t_f = 1.8$ ns;
 PRR = Variable; Duty Cycle = 50%.

Figure 7. I_{CCD} Test Circuit

ORDERING INFORMATION

Part Number	Top Mark	Package	Shipping [†]
NC7WZ07P6X	Z07	SC-88	3000 / Tape & Reel
NC7WZ07P6X-L22347	Z07	SC-88	3000 / Tape & Reel
NC7WZ07L6X	D3	MicroPak	5000 / Tape & Reel
NC7WZ07L6X-L22175	D3	MicroPak	5000 / Tape & Reel
NC7WZ07FHX	D3	MicroPak2	5000 / Tape & Reel
NC7WZ07FHX-L22175	D3	MicroPak2	5000 / Tape & Reel

[†]For information on tape and reel specifications, including part orientation and tape sizes, please refer to our Tape and Reel Packaging Specifications Brochure, BRD8011/D.

MicroPak and MicroPak2 are trademarks of Semiconductor Components Industries, LLC dba "onsemi" or its affiliates and/or subsidiaries in the United States and/or other countries.

SIP6 1.45X1.0
CASE 127EB
ISSUE O

DATE 31 AUG 2016

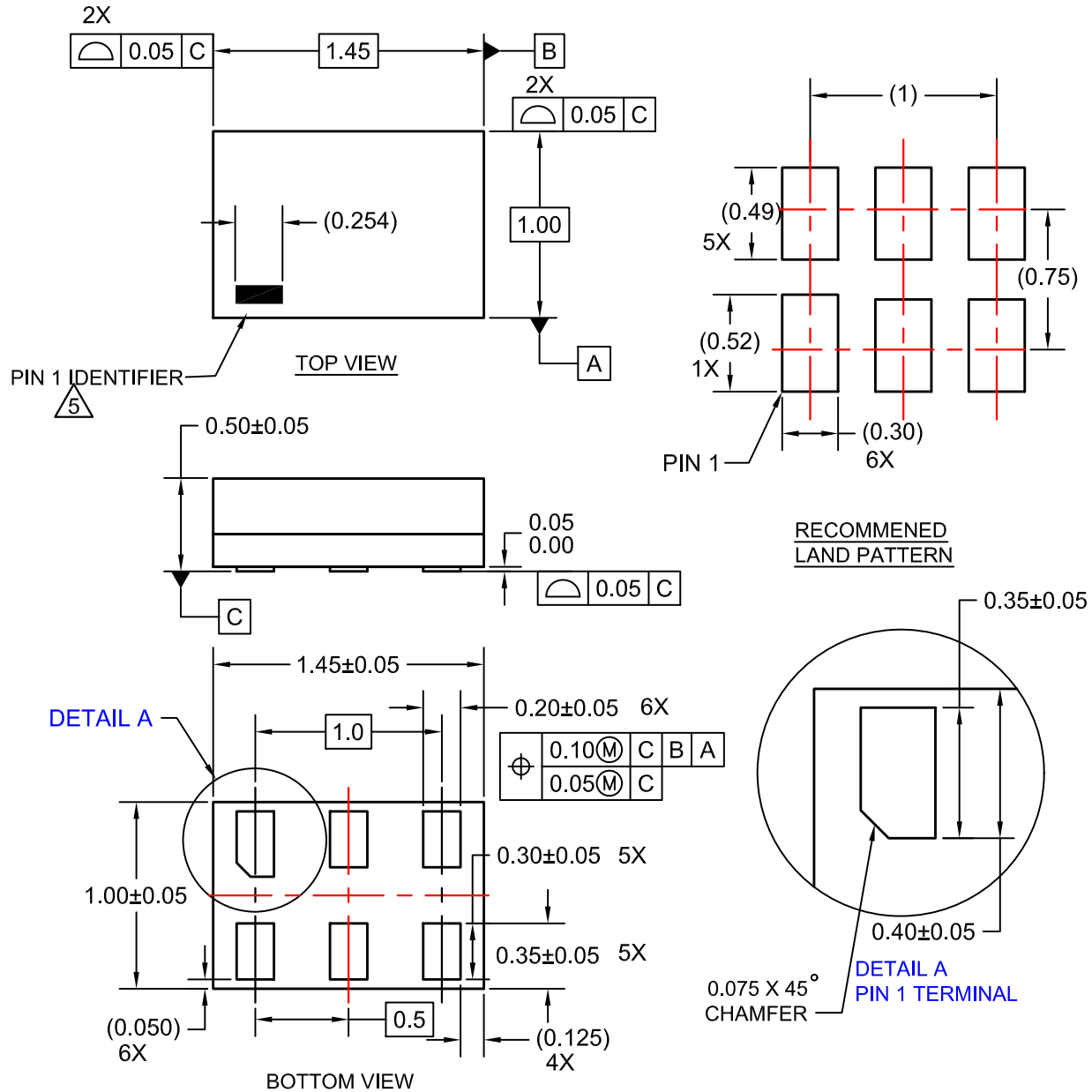

NOTES:

1. CONFORMS TO JEDEC STANDARD MO-252 VARIATION UAAD
2. DIMENSIONS ARE IN MILLIMETERS
3. DRAWING CONFORMS TO ASME Y14.5M-2009
4. PIN ONE IDENTIFIER IS 2X LENGTH OF ANY OTHER LINE IN THE MARK CODE LAYOUT.

DOCUMENT NUMBER:	98AON13590G	Electronic versions are uncontrolled except when accessed directly from the Document Repository. Printed versions are uncontrolled except when stamped "CONTROLLED COPY" in red.
DESCRIPTION:	SIP6 1.45X1.0	PAGE 1 OF 1

ON Semiconductor and **ON** are trademarks of Semiconductor Components Industries, LLC dba ON Semiconductor or its subsidiaries in the United States and/or other countries. ON Semiconductor reserves the right to make changes without further notice to any products herein. ON Semiconductor makes no warranty, representation or guarantee regarding the suitability of its products for any particular purpose, nor does ON Semiconductor assume any liability arising out of the application or use of any product or circuit, and specifically disclaims any and all liability, including without limitation special, consequential or incidental damages. ON Semiconductor does not convey any license under its patent rights nor the rights of others.

MECHANICAL CASE OUTLINE
PACKAGE DIMENSIONS

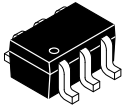

1

SC-88 (SC-70 6 Lead), 1.25x2
CASE 419AD
ISSUE A

DATE 07 JUL 2010

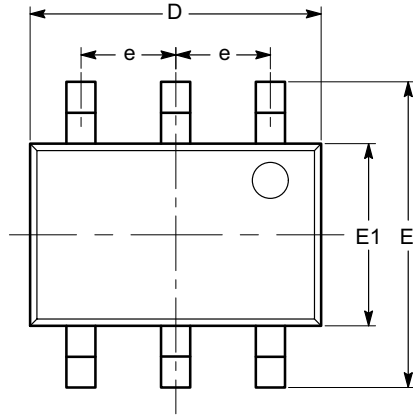

TOP VIEW

SYMBOL	MIN	NOM	MAX
A	0.80		1.10
A1	0.00		0.10
A2	0.80		1.00
b	0.15		0.30
c	0.10		0.18
D	1.80	2.00	2.20
E	1.80	2.10	2.40
E1	1.15	1.25	1.35
e	0.65 BSC		
L	0.26	0.36	0.46
L1	0.42 REF		
L2	0.15 BSC		
θ	0°		8°
θ_1	4°		10°

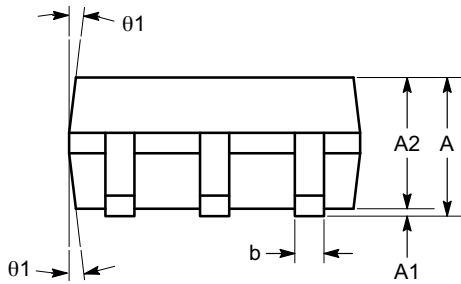

SIDE VIEW



END VIEW

Notes:

- (1) All dimensions are in millimeters. Angles in degrees.
- (2) Complies with JEDEC MO-203.

DOCUMENT NUMBER:	98AON34266E	Electronic versions are uncontrolled except when accessed directly from the Document Repository. Printed versions are uncontrolled except when stamped "CONTROLLED COPY" in red.
DESCRIPTION:	SC-88 (SC-70 6 LEAD), 1.25X2	PAGE 1 OF 1

onsemi and ONSEMI are trademarks of Semiconductor Components Industries, LLC dba onsemi or its subsidiaries in the United States and/or other countries. onsemi reserves the right to make changes without further notice to any products herein. onsemi makes no warranty, representation or guarantee regarding the suitability of its products for any particular purpose, nor does onsemi assume any liability arising out of the application or use of any product or circuit, and specifically disclaims any and all liability, including without limitation special, consequential or incidental damages. onsemi does not convey any license under its patent rights nor the rights of others.



1
SCALE 2:1

SC-88/SC70-6/SOT-363
CASE 419B-02
ISSUE Y

DATE 11 DEC 2012

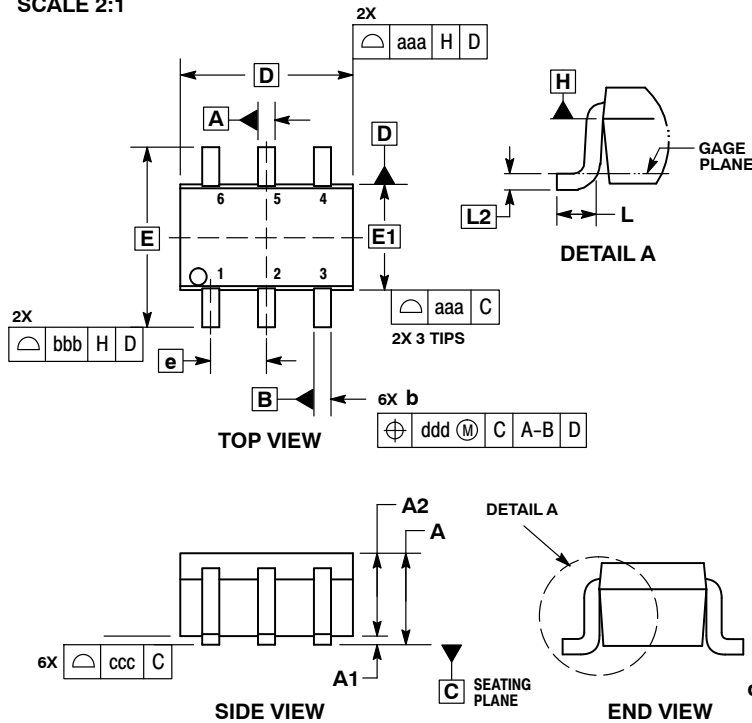

- NOTES:
1. DIMENSIONING AND TOLERANCING PER ASME Y14.5M, 1994.
 2. CONTROLLING DIMENSION: MILLIMETERS.
 3. DIMENSIONS D AND E1 DO NOT INCLUDE MOLD FLASH, PROTRUSIONS, OR GATE BURRS. MOLD FLASH, PROTRUSIONS, OR GATE BURRS SHALL NOT EXCEED 0.20 PER END.
 4. DIMENSIONS D AND E1 AT THE OUTERMOST EXTREMES OF THE PLASTIC BODY AND DATUM H.
 5. DATUMS A AND B ARE DETERMINED AT DATUM H.
 6. DIMENSIONS b AND c APPLY TO THE FLAT SECTION OF THE LEAD BETWEEN 0.08 AND 0.15 FROM THE TIP.
 7. DIMENSION b DOES NOT INCLUDE DAMBAR PROTRUSION. ALLOWABLE DAMBAR PROTRUSION SHALL BE 0.08 TOTAL IN EXCESS OF DIMENSION b AT MAXIMUM MATERIAL CONDITION. THE DAMBAR CANNOT BE LOCATED ON THE LOWER RADIUS OF THE FOOT.

DIM	MILLIMETERS			INCHES		
	MIN	NOM	MAX	MIN	NOM	MAX
A	---	---	1.10	---	---	0.043
A1	0.00	---	0.10	0.000	---	0.004
A2	0.70	0.90	1.00	0.027	0.035	0.039
b	0.15	0.20	0.25	0.006	0.008	0.010
C	0.08	0.15	0.22	0.003	0.006	0.009
D	1.80	2.00	2.20	0.070	0.078	0.086
E	2.00	2.10	2.20	0.078	0.082	0.086
E1	1.15	1.25	1.35	0.045	0.049	0.053
e	0.65 BSC			0.026 BSC		
L	0.26	0.36	0.46	0.010	0.014	0.018
L2	0.15 BSC			0.006 BSC		
aaa	0.15			0.006		
bbb	0.30			0.012		
ccc	0.10			0.004		
ddd	0.10			0.004		

GENERIC MARKING DIAGRAM*

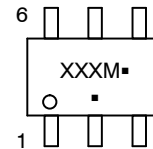

- XXX = Specific Device Code
- M = Date Code*
- = Pb-Free Package

(Note: Microdot may be in either location)

*Date Code orientation and/or position may vary depending upon manufacturing location.

*This information is generic. Please refer to device data sheet for actual part marking. Pb-Free indicator, "G" or microdot "▪", may or may not be present. Some products may not follow the Generic Marking.

RECOMMENDED SOLDERING FOOTPRINT*

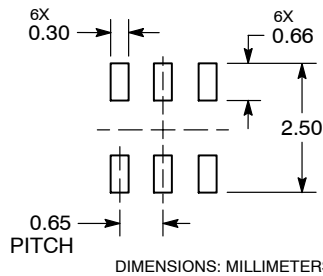

DIMENSIONS: MILLIMETERS

*For additional information on our Pb-Free strategy and soldering details, please download the ON Semiconductor Soldering and Mounting Techniques Reference Manual, SOLDERRM/D.

STYLES ON PAGE 2

DOCUMENT NUMBER:	98ASB42985B	Electronic versions are uncontrolled except when accessed directly from the Document Repository. Printed versions are uncontrolled except when stamped "CONTROLLED COPY" in red.
DESCRIPTION:	SC-88/SC70-6/SOT-363	PAGE 1 OF 2

ON Semiconductor and ON are trademarks of Semiconductor Components Industries, LLC dba ON Semiconductor or its subsidiaries in the United States and/or other countries. ON Semiconductor reserves the right to make changes without further notice to any products herein. ON Semiconductor makes no warranty, representation or guarantee regarding the suitability of its products for any particular purpose, nor does ON Semiconductor assume any liability arising out of the application or use of any product or circuit, and specifically disclaims any and all liability, including without limitation special, consequential or incidental damages. ON Semiconductor does not convey any license under its patent rights nor the rights of others.

SC-88/SC70-6/SOT-363
CASE 419B-02
ISSUE Y

DATE 11 DEC 2012

STYLE 1: PIN 1. EMITTER 2 2. BASE 2 3. COLLECTOR 1 4. EMITTER 1 5. BASE 1 6. COLLECTOR 2	STYLE 2: CANCELLED	STYLE 3: CANCELLED	STYLE 4: PIN 1. CATHODE 2. CATHODE 3. COLLECTOR 4. EMITTER 5. BASE 6. ANODE	STYLE 5: PIN 1. ANODE 2. ANODE 3. COLLECTOR 4. EMITTER 5. BASE 6. CATHODE	STYLE 6: PIN 1. ANODE 2 2. N/C 3. CATHODE 1 4. ANODE 1 5. N/C 6. CATHODE 2
STYLE 7: PIN 1. SOURCE 2 2. DRAIN 2 3. GATE 1 4. SOURCE 1 5. DRAIN 1 6. GATE 2	STYLE 8: CANCELLED	STYLE 9: PIN 1. EMITTER 2 2. EMITTER 1 3. COLLECTOR 1 4. BASE 1 5. BASE 2 6. COLLECTOR 2	STYLE 10: PIN 1. SOURCE 2 2. SOURCE 1 3. GATE 1 4. DRAIN 1 5. DRAIN 2 6. GATE 2	STYLE 11: PIN 1. CATHODE 2 2. CATHODE 2 3. ANODE 1 4. CATHODE 1 5. CATHODE 1 6. ANODE 2	STYLE 12: PIN 1. ANODE 2 2. ANODE 2 3. CATHODE 1 4. ANODE 1 5. ANODE 1 6. CATHODE 2
STYLE 13: PIN 1. ANODE 2. N/C 3. COLLECTOR 4. EMITTER 5. BASE 6. CATHODE	STYLE 14: PIN 1. VREF 2. GND 3. GND 4. IOUT 5. VEN 6. VCC	STYLE 15: PIN 1. ANODE 1 2. ANODE 2 3. ANODE 3 4. CATHODE 3 5. CATHODE 2 6. CATHODE 1	STYLE 16: PIN 1. BASE 1 2. EMITTER 2 3. COLLECTOR 2 4. BASE 2 5. EMITTER 1 6. COLLECTOR 1	STYLE 17: PIN 1. BASE 1 2. EMITTER 1 3. COLLECTOR 2 4. BASE 2 5. EMITTER 2 6. COLLECTOR 1	STYLE 18: PIN 1. VIN1 2. VCC 3. VOUT2 4. VIN2 5. GND 6. VOUT1
STYLE 19: PIN 1. IOUT 2. GND 3. GND 4. V CC 5. V EN 6. V REF	STYLE 20: PIN 1. COLLECTOR 2. COLLECTOR 3. BASE 4. EMITTER 5. COLLECTOR 6. COLLECTOR	STYLE 21: PIN 1. ANODE 1 2. N/C 3. ANODE 2 4. CATHODE 2 5. N/C 6. CATHODE 1	STYLE 22: PIN 1. D1 (i) 2. GND 3. D2 (i) 4. D2 (c) 5. VBUS 6. D1 (c)	STYLE 23: PIN 1. Vn 2. CH1 3. Vp 4. N/C 5. CH2 6. N/C	STYLE 24: PIN 1. CATHODE 2. ANODE 3. CATHODE 4. CATHODE 5. CATHODE 6. CATHODE
STYLE 25: PIN 1. BASE 1 2. CATHODE 3. COLLECTOR 2 4. BASE 2 5. EMITTER 6. COLLECTOR 1	STYLE 26: PIN 1. SOURCE 1 2. GATE 1 3. DRAIN 2 4. SOURCE 2 5. GATE 2 6. DRAIN 1	STYLE 27: PIN 1. BASE 2 2. BASE 1 3. COLLECTOR 1 4. EMITTER 1 5. EMITTER 2 6. COLLECTOR 2	STYLE 28: PIN 1. DRAIN 2. DRAIN 3. GATE 4. SOURCE 5. DRAIN 6. DRAIN	STYLE 29: PIN 1. ANODE 2. ANODE 3. COLLECTOR 4. EMITTER 5. BASE/ANODE 6. CATHODE	STYLE 30: PIN 1. SOURCE 1 2. DRAIN 2 3. DRAIN 2 4. SOURCE 2 5. GATE 1 6. DRAIN 1

Note: Please refer to datasheet for style callout. If style type is not called out in the datasheet refer to the device datasheet pinout or pin assignment.

DOCUMENT NUMBER:	98ASB42985B	Electronic versions are uncontrolled except when accessed directly from the Document Repository. Printed versions are uncontrolled except when stamped "CONTROLLED COPY" in red.
DESCRIPTION:	SC-88/SC70-6/SOT-363	PAGE 2 OF 2

ON Semiconductor and  are trademarks of Semiconductor Components Industries, LLC dba ON Semiconductor or its subsidiaries in the United States and/or other countries. ON Semiconductor reserves the right to make changes without further notice to any products herein. ON Semiconductor makes no warranty, representation or guarantee regarding the suitability of its products for any particular purpose, nor does ON Semiconductor assume any liability arising out of the application or use of any product or circuit, and specifically disclaims any and all liability, including without limitation special, consequential or incidental damages. ON Semiconductor does not convey any license under its patent rights nor the rights of others.

MECHANICAL CASE OUTLINE

PACKAGE DIMENSIONS

ON Semiconductor®



UDFN6 1.0X1.0, 0.35P
CASE 517DP
ISSUE O

DATE 31 AUG 2016

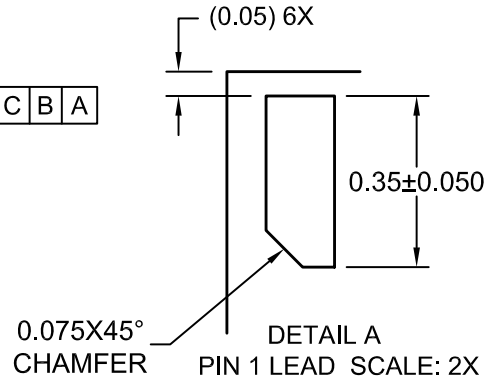
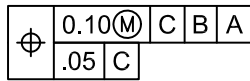
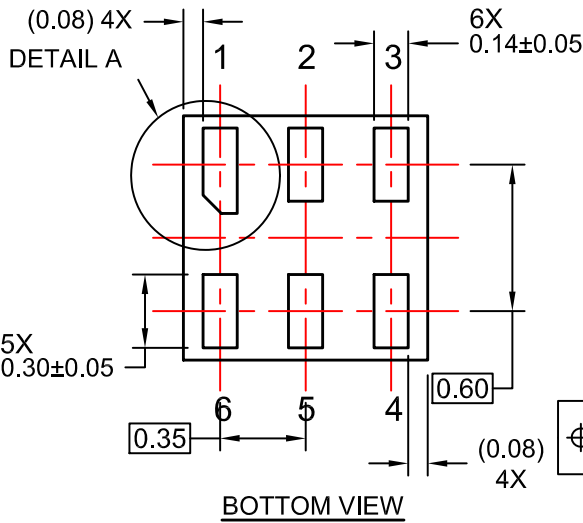
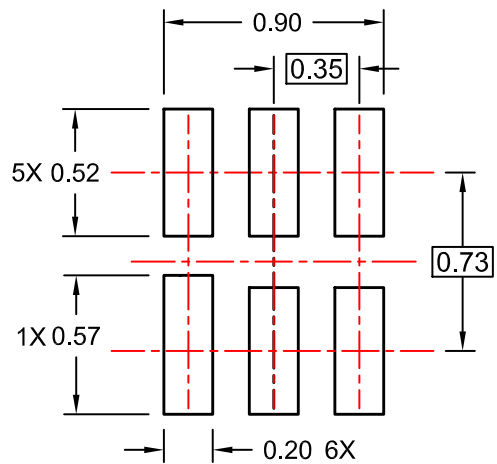
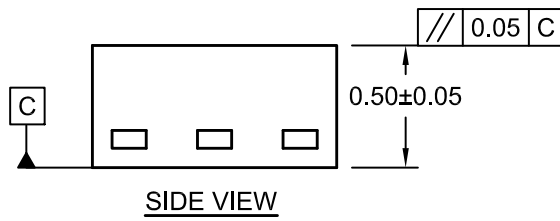
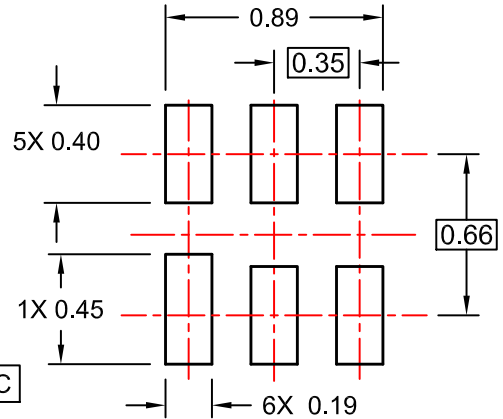
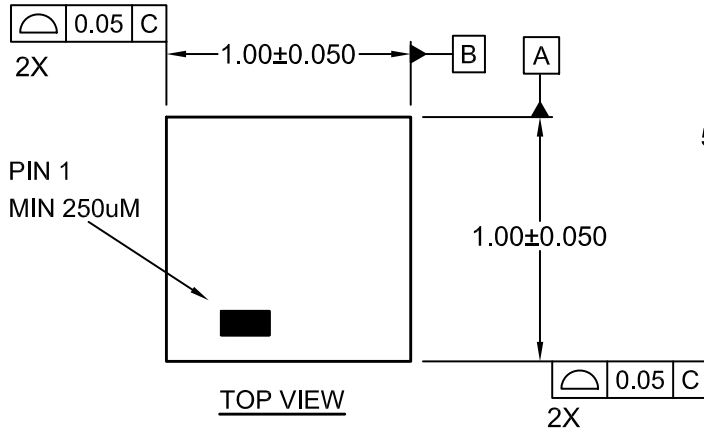

- NOTES:
- A. COMPLIES TO JEDEC MO-252 STANDARD
 - B. DIMENSIONS ARE IN MILLIMETERS.
 - C. DIMENSIONS AND TOLERANCES PER ASME Y14.5M, 2009

DOCUMENT NUMBER:	98AON13593G	Electronic versions are uncontrolled except when accessed directly from the Document Repository. Printed versions are uncontrolled except when stamped "CONTROLLED COPY" in red.
DESCRIPTION:	UDFN6 1.0X1.0, 0.35P	PAGE 1 OF 1

ON Semiconductor and are trademarks of Semiconductor Components Industries, LLC dba ON Semiconductor or its subsidiaries in the United States and/or other countries. ON Semiconductor reserves the right to make changes without further notice to any products herein. ON Semiconductor makes no warranty, representation or guarantee regarding the suitability of its products for any particular purpose, nor does ON Semiconductor assume any liability arising out of the application or use of any product or circuit, and specifically disclaims any and all liability, including without limitation special, consequential or incidental damages. ON Semiconductor does not convey any license under its patent rights nor the rights of others.

onsemi, **Onsemi**, and other names, marks, and brands are registered and/or common law trademarks of Semiconductor Components Industries, LLC dba "**onsemi**" or its affiliates and/or subsidiaries in the United States and/or other countries. **onsemi** owns the rights to a number of patents, trademarks, copyrights, trade secrets, and other intellectual property. A listing of **onsemi**'s product/patent coverage may be accessed at www.onsemi.com/site/pdf/Patent-Marking.pdf. **onsemi** reserves the right to make changes at any time to any products or information herein, without notice. The information herein is provided "as-is" and **onsemi** makes no warranty, representation or guarantee regarding the accuracy of the information, product features, availability, functionality, or suitability of its products for any particular purpose, nor does **onsemi** assume any liability arising out of the application or use of any product or circuit, and specifically disclaims any and all liability, including without limitation special, consequential or incidental damages. Buyer is responsible for its products and applications using **onsemi** products, including compliance with all laws, regulations and safety requirements or standards, regardless of any support or applications information provided by **onsemi**. "Typical" parameters which may be provided in **onsemi** data sheets and/or specifications can and do vary in different applications and actual performance may vary over time. All operating parameters, including "Typicals" must be validated for each customer application by customer's technical experts. **onsemi** does not convey any license under any of its intellectual property rights nor the rights of others. **onsemi** products are not designed, intended, or authorized for use as a critical component in life support systems or any FDA Class 3 medical devices or medical devices with a same or similar classification in a foreign jurisdiction or any devices intended for implantation in the human body. Should Buyer purchase or use **onsemi** products for any such unintended or unauthorized application, Buyer shall indemnify and hold **onsemi** and its officers, employees, subsidiaries, affiliates, and distributors harmless against all claims, costs, damages, and expenses, and reasonable attorney fees arising out of, directly or indirectly, any claim of personal injury or death associated with such unintended or unauthorized use, even if such claim alleges that **onsemi** was negligent regarding the design or manufacture of the part. **onsemi** is an Equal Opportunity/Affirmative Action Employer. This literature is subject to all applicable copyright laws and is not for resale in any manner.

PUBLICATION ORDERING INFORMATION

LITERATURE FULFILLMENT:

Email Requests to: orderlit@onsemi.com

onsemi Website: www.onsemi.com

TECHNICAL SUPPORT

North American Technical Support:
Voice Mail: 1 800-282-9855 Toll Free USA/Canada
Phone: 011 421 33 790 2910

Europe, Middle East and Africa Technical Support:

Phone: 00421 33 790 2910

For additional information, please contact your local Sales Representative

