

MC74AC157, MC74ACT157

Quad 2-Input Multiplexer

The MC74AC157/74ACT157 is a high-speed quad 2-input multiplexer. Four bits of data from two sources can be selected using the common Select and Enable inputs. The four outputs present the selected data in the true (non-inverted) form.

The MC74AC157/74ACT157 can also be used as a function generator.

Features

- Outputs Source/Sink 24 mA
- 'ACT157 Has TTL Compatible Inputs
- These are Pb-Free Devices

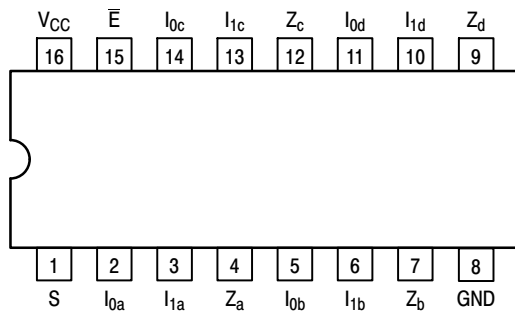

Figure 1. Pinout: 16-Lead Packages Conductors (Top View)

TRUTH TABLE

Inputs				Outputs
E	S	I ₀	I ₁	Z
H	X	X	X	L
L	H	X	L	L
L	H	X	H	H
L	L	L	X	L
L	L	H	X	H

H = HIGH Voltage Level
L = LOW Voltage Level
X = Immaterial



ON Semiconductor®

www.onsemi.com

MARKING DIAGRAMS

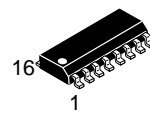

SOIC-16
D SUFFIX
CASE 751B

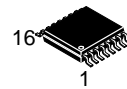
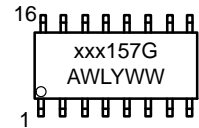

TSSOP-16
DT SUFFIX
CASE 948F

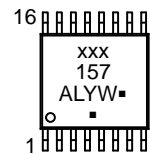

xxx = AC or ACT
A = Assembly Location
WL or L = Wafer Lot
Y = Year
WW or W = Work Week
G or ■ = Pb-Free Package

(Note: Microdot may be in either location)

PIN NAMES

PIN	FUNCTION
I _{0a} -I _{0d}	Source 0 Data Inputs
I _{1a} -I _{1d}	Source 1 Data Inputs
E	Enable Input
S	Select Input
Z _a -Z _d	Outputs

ORDERING INFORMATION

See detailed ordering and shipping information in the package dimensions section on page 6 of this data sheet.

MC74AC157, MC74ACT157

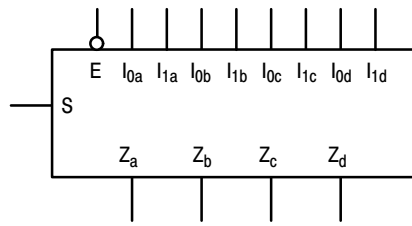

Figure 2. Logic Symbol

FUNCTIONAL DESCRIPTION

The MC74AC157/74ACT157 is a quad 2-input multiplexer. It selects four bits of data from two sources under the control of a common Select input (S). The Enable input (\bar{E}) is active-LOW. When \bar{E} is HIGH, all of the outputs (Z) are forced LOW regardless of all other inputs. The MC74AC157/74ACT157 is the logic implementation of a 4-pole, 2-position switch where the position of the switch is determined by the logic levels supplied to the Select input. The logic equations for the outputs are shown below:

$$Z_a = \bar{E} \cdot (I_{1a} \cdot S + I_{0a} \cdot \bar{S})$$

$$Z_b = \bar{E} \cdot (I_{1b} \cdot S + I_{0b} \cdot \bar{S})$$

$$Z_c = \bar{E} \cdot (I_{1c} \cdot S + I_{0c} \cdot \bar{S})$$

$$Z_d = \bar{E} \cdot (I_{1d} \cdot S + I_{0d} \cdot \bar{S})$$

A common use of the MC74AC157/74ACT157 is the moving of data from two groups of registers to four common output busses. The particular register from which the data comes is determined by the state of the Select input. A less obvious use is as a function generator. The MC74AC157/74ACT157 can generate any four of the sixteen different functions of two variables with one variable common. This is useful for implementing gating functions.

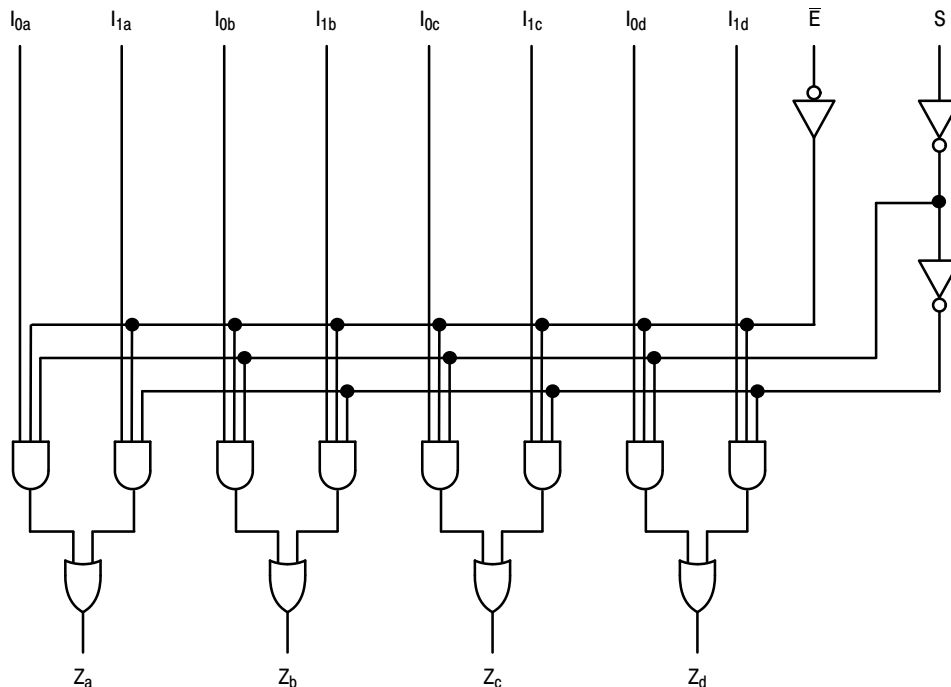

NOTE: This diagram is provided only for the understanding of logic operations and should not be used to estimate propagation delays.

Figure 3. Logic Diagram

MC74AC157, MC74ACT157

MAXIMUM RATINGS

Symbol	Parameter	Value	Unit
V _{CC}	DC Supply Voltage	-0.5 to +7.0	V
V _I	DC Input Voltage	-0.5 ≤ V _I ≤ V _{CC} + 0.5	V
V _O	DC Output Voltage (Note 1)	-0.5 ≤ V _O ≤ V _{CC} + 0.5	V
I _{IK}	DC Input Diode Current	±20	mA
I _{OK}	DC Output Diode Current	±50	mA
I _O	DC Output Sink/Source Current	±50	mA
I _{CC}	DC Supply Current per Output Pin	±50	mA
I _{GND}	DC Ground Current per Output Pin	±50	mA
T _{STG}	Storage Temperature Range	-65 to +150	°C
T _L	Lead temperature, 1 mm from Case for 10 Seconds	260	°C
T _J	Junction temperature under Bias	+150	°C
θ _{JA}	Thermal Resistance (Note 2)	SOIC TSSOP 69.1 103.8	°C/W
P _D	Power Dissipation in Still Air at 65°C (Note 3)	SOIC TSSOP 500 500	mW
MSL	Moisture Sensitivity	Level 1	
F _R	Flammability Rating	Oxygen Index: 30% – 35% UL 94 V-0 @ 0.125 in	
V _{ESD}	ESD Withstand Voltage	Human Body Model (Note 4) Machine Model (Note 5) Charged Device Model (Note 6) > 2000 > 200 > 1000	V
I _{Latch-Up}	Latch-Up Performance Above V _{CC} and Below GND at 85°C (Note 7)	±100	mA

Stresses exceeding those listed in the Maximum Ratings table may damage the device. If any of these limits are exceeded, device functionality should not be assumed, damage may occur and reliability may be affected.

1. I_O absolute maximum rating must be observed.
2. The package thermal impedance is calculated in accordance with JEDEC51-7.
3. 500 mW at 65°C; derate to 300 mW by 10 mW/°C from 65°C to 85°C.
4. Tested to EIA/JESD22-A114-A.
5. Tested to EIA/JESD22-A115-A.
6. Tested to JESD22-C101-A.
7. Tested to EIA/JESD78.

RECOMMENDED OPERATING CONDITIONS

Symbol	Parameter	Min	Typ	Max	Unit	
V _{CC}	Supply Voltage	'AC	2.0	5.0	6.0	V
		'ACT	4.5	5.0	5.5	
V _{IN} , V _{OUT}	DC Input Voltage, Output Voltage (Ref. to GND)	0	-	V _{CC}	V	
t _r , t _f	Input Rise and Fall Time (Note 1) 'AC Devices except Schmitt Inputs	V _{CC} @ 3.0 V	-	150	-	ns/V
		V _{CC} @ 4.5 V	-	40	-	
		V _{CC} @ 5.5 V	-	25	-	
t _r , t _f	Input Rise and Fall Time (Note 2) 'ACT Devices except Schmitt Inputs	V _{CC} @ 4.5 V	-	10	-	ns/V
		V _{CC} @ 5.5 V	-	8.0	-	
T _J	Junction Temperature (PDIP)	-	-	140	°C	
T _A	Operating Ambient Temperature Range	-40	25	85	°C	
I _{OH}	Output Current – High	-	-	-24	mA	
I _{OL}	Output Current – Low	-	-	24	mA	

Functional operation above the stresses listed in the Recommended Operating Ranges is not implied. Extended exposure to stresses beyond the Recommended Operating Ranges limits may affect device reliability.

1. V_{IN} from 30% to 70% V_{CC}; see individual Data Sheets for devices that differ from the typical input rise and fall times.
2. V_{IN} from 0.8 V to 2.0 V; see individual Data Sheets for devices that differ from the typical input rise and fall times.

MC74AC157, MC74ACT157

DC CHARACTERISTICS

Symbol	Parameter	V _{CC} (V)	74AC		74AC		Unit	Conditions
			T _A = +25°C		T _A = -40°C to +85°C			
			Typ	Guaranteed Limits				
V _{IH}	Minimum High Level Input Voltage	3.0	1.5	2.1	2.1	V	V _{OUT} = 0.1 V or V _{CC} - 0.1 V	
		4.5	2.25	3.15	3.15			
		5.5	2.75	3.85	3.85			
V _{IL}	Maximum Low Level Input Voltage	3.0	1.5	0.9	0.9	V	V _{OUT} = 0.1 V or V _{CC} - 0.1 V	
		4.5	2.25	1.35	1.35			
		5.5	2.75	1.65	1.65			
V _{OH}	Minimum High Level Output Voltage	3.0	2.99	2.9	2.9	V	I _{OUT} = -50 μA	
		4.5	4.49	4.4	4.4			
		5.5	5.49	5.4	5.4			
	3.0	-	-	2.56	2.46	V	*V _{IN} = V _{IL} or V _{IH} -12 mA I _{OH} = -24 mA -24 mA	
				4.5	3.86			3.76
				5.5	4.86			4.76
V _{OL}	Maximum Low Level Output Voltage	3.0	0.002	0.1	0.1	V	I _{OUT} = 50 μA	
		4.5	0.001	0.1	0.1			
		5.5	0.001	0.1	0.1			
	3.0	-	-	0.36	0.44	V	*V _{IN} = V _{IL} or V _{IH} 12 mA I _{OL} = 24 mA 24 mA	
				4.5	0.36			0.44
				5.5	0.36			0.44
I _{IN}	Maximum Input Leakage Current	5.5	-	±0.1	±1.0	μA	V _I = V _{CC} , GND	
I _{OLD}	†Minimum Dynamic Output Current	5.5	-	-	75	mA	V _{OLD} = 1.65 V Max	
I _{OHD}		5.5	-	-	-75	mA	V _{OHD} = 3.85 V Min	
I _{CC}	Maximum Quiescent Supply Current	5.5	-	8.0	80	μA	V _{IN} = V _{CC} or GND	

*All outputs loaded; thresholds on input associated with output under test.

†Maximum test duration 2.0 ms, one output loaded at a time.

NOTE: I_{IN} and I_{CC} @ 3.0 V are guaranteed to be less than or equal to the respective limit @ 5.5 V V_{CC}.

AC CHARACTERISTICS (For Figures and Waveforms – See Section 3 of the ON Semiconductor FACT Data Book, DL138/D)

Symbol	Parameter	V _{CC} * (V)	74AC			74AC		Unit	Fig. No.
			T _A = +25°C C _L = 50 pF			T _A = -40°C to +85°C C _L = 50 pF			
			Min	Typ	Max	Min	Max		
t _{PLH}	Propagation Delay S to Z _n	3.3	1.5	7.0	11.5	1.5	13.0	ns	3-6
		5.0	1.5	5.5	9.0	1.5	10.0		
t _{PHL}	Propagation Delay S to Z _n	3.3	1.5	6.5	11.0	1.5	12.0	ns	3-6
		5.0	1.5	5.0	8.5	1.0	9.5		
t _{PLH}	Propagation Delay \bar{E} to Z _n	3.3	1.5	7.0	11.5	1.5	13.0	ns	3-6
		5.0	1.5	5.5	9.0	1.5	10.0		
t _{PHL}	Propagation Delay \bar{E}_n to Z _n	3.3	1.5	6.5	11.0	1.5	12	ns	3-6
		5.0	1.5	5.5	9.0	1.0	9.5		
t _{PLH}	Propagation Delay I _n to Z _n	3.3	1.5	5.0	8.5	1.0	9.0	ns	3-5
		5.0	1.5	4.0	6.5	1.0	7.0		
t _{PHL}	Propagation Delay I _n to Z _n	3.3	1.5	5.0	8.0	1.0	9.0	ns	3-5
		5.0	1.5	4.0	6.5	1.0	7.0		

*Voltage Range 3.3 V is 3.3 V ±0.3 V.

*Voltage Range 5.0 V is 5.0 V ±0.5 V.

MC74AC157, MC74ACT157

DC CHARACTERISTICS

Symbol	Parameter	V _{CC} (V)	74ACT		74ACT		Unit	Conditions
			T _A = +25°C		T _A = -40°C to +85°C			
			Typ	Guaranteed Limits				
V _{IH}	Minimum High Level Input Voltage	4.5	1.5	2.0	2.0		V	V _{OUT} = 0.1 V or V _{CC} - 0.1 V
		5.5	1.5	2.0	2.0			
V _{IL}	Maximum Low Level Input Voltage	4.5	1.5	0.8	0.8		V	V _{OUT} = 0.1 V or V _{CC} - 0.1 V
		5.5	1.5	0.8	0.8			
V _{OH}	Minimum High Level Output Voltage	4.5	4.49	4.4	4.4		V	I _{OUT} = -50 μA
		5.5	5.49	5.4	5.4			
		4.5	-	3.86	3.76		V	*V _{IN} = V _{IL} or V _{IH} -24 mA I _{OH} -24 mA
		5.5	-	4.86	4.76			
V _{OL}	Maximum Low Level Output Voltage	4.5	0.001	0.1	0.1		V	I _{OUT} = 50 μA
		5.5	0.001	0.1	0.1			
		4.5	-	0.36	0.44		V	*V _{IN} = V _{IL} or V _{IH} 24 mA I _{OL} 24 mA
		5.5	-	0.36	0.44			
I _{IN}	Maximum Input Leakage Current	5.5	-	±0.1	±1.0		μA	V _I = V _{CC} , GND
ΔI _{CCT}	Additional Max. I _{CC} /Input	5.5	0.6	-	1.5		mA	V _I = V _{CC} - 2.1 V
I _{OLD}	†Minimum Dynamic Output Current	5.5	-	-	75		mA	V _{OLD} = 1.65 V Max
I _{OHD}		5.5	-	-	-75		mA	V _{OHD} = 3.85 V Min
I _{CC}	Maximum Quiescent Supply Current	5.5	-	8.0	80		μA	V _{IN} = V _{CC} or GND

*All outputs loaded; thresholds on input associated with output under test.

†Maximum test duration 2.0 ms, one output loaded at a time.

AC CHARACTERISTICS (For Figures and Waveforms – See Section 3 of the ON Semiconductor FACT Data Book, DL138/D)

Symbol	Parameter	V _{CC} * (V)	74ACT			74ACT		Unit	Fig. No.
			T _A = +25°C C _L = 50 pF			T _A = -40°C to +85°C C _L = 50 pF			
			Min	Typ	Max	Min	Max		
t _{PLH}	Propagation Delay S to Z _n	5.0	2.0	-	9.0	1.5	10.0	ns	3-6
t _{PHL}	Propagation Delay S to Z _n	5.0	2.0	-	9.5	2.0	10.5	ns	3-6
t _{PLH}	Propagation Delay E _n to Z _n	5.0	1.5	-	10	1.5	11.5	ns	3-6
t _{PHL}	Propagation Delay E _n to Z _n	5.0	1.5	-	8.5	1.0	9.0	ns	3-6
t _{PLH}	Propagation Delay I _n to Z _n	5.0	1.5	-	7.0	1.0	8.5	ns	3-5
t _{PHL}	Propagation Delay I _n to Z _n	5.0	1.5	-	7.5	1.0	8.5	ns	3-5

*Voltage Range 5.0 V is 5.0 V ±0.5 V.

CAPACITANCE

Symbol	Parameter	Value – Typ	Unit	Test Conditions
C _{IN}	Input Capacitance	4.5	pF	V _{CC} = 5.0 V
C _{PD}	Power Dissipation Capacitance	50	pF	V _{CC} = 5.0 V

MC74AC157, MC74ACT157

ORDERING INFORMATION

Device Order Number	Package	Shipping†
MC74AC157DG	SOIC-16 (Pb-Free)	48 Units / Rail
MC74AC157DR2G	SOIC-16 (Pb-Free)	2500 Tape & Reel
MC74AC157DTR2G	TSSOP-16 (Pb-Free)	2500 Tape & Reel
MC74ACT157DG	SOIC-16 (Pb-Free)	48 Units / Rail
MC74ACT157DR2G	SOIC-16 (Pb-Free)	2500 Tape & Reel
MC74ACT157DTR2G	TSSOP-16 (Pb-Free)	2500 Tape & Reel

†For information on tape and reel specifications, including part orientation and tape sizes, please refer to our Tape and Reel Packaging Specifications Brochure, BRD8011/D.

MECHANICAL CASE OUTLINE PACKAGE DIMENSIONS

ON Semiconductor®



SCALE 1:1

SOIC-16 CASE 751B-05 ISSUE K

DATE 29 DEC 2006



NOTES:

1. DIMENSIONING AND TOLERANCING PER ANSI Y14.5M, 1982.
2. CONTROLLING DIMENSION: MILLIMETER.
3. DIMENSIONS A AND B DO NOT INCLUDE MOLD PROTRUSION.
4. MAXIMUM MOLD PROTRUSION 0.15 (0.006) PER SIDE.
5. DIMENSION D DOES NOT INCLUDE DAMBAR PROTRUSION. ALLOWABLE DAMBAR PROTRUSION SHALL BE 0.127 (0.005) TOTAL IN EXCESS OF THE D DIMENSION AT MAXIMUM MATERIAL CONDITION.

DIM	MILLIMETERS		INCHES	
	MIN	MAX	MIN	MAX
A	9.80	10.00	0.386	0.393
B	3.80	4.00	0.150	0.157
C	1.35	1.75	0.054	0.068
D	0.35	0.49	0.014	0.019
F	0.40	1.25	0.016	0.049
G	1.27 BSC		0.050 BSC	
J	0.19	0.25	0.008	0.009
K	0.10	0.25	0.004	0.009
M	0°	7°	0°	7°
P	5.80	6.20	0.229	0.244
R	0.25	0.50	0.010	0.019

- | | | | |
|--|--|--|--|
| <p>STYLE 1:</p> <p>PIN 1. COLLECTOR
2. BASE
3. EMITTER
4. NO CONNECTION
5. EMITTER
6. BASE
7. COLLECTOR
8. COLLECTOR
9. BASE
10. EMITTER
11. NO CONNECTION
12. EMITTER
13. BASE
14. COLLECTOR
15. EMITTER
16. COLLECTOR</p> | <p>STYLE 2:</p> <p>PIN 1. CATHODE
2. ANODE
3. NO CONNECTION
4. CATHODE
5. CATHODE
6. NO CONNECTION
7. ANODE
8. CATHODE
9. CATHODE
10. ANODE
11. NO CONNECTION
12. CATHODE
13. CATHODE
14. NO CONNECTION
15. ANODE
16. CATHODE</p> | <p>STYLE 3:</p> <p>PIN 1. COLLECTOR, DYE #1
2. BASE, #1
3. EMITTER, #1
4. COLLECTOR, #1
5. COLLECTOR, #2
6. BASE, #2
7. EMITTER, #2
8. COLLECTOR, #2
9. COLLECTOR, #3
10. BASE, #3
11. EMITTER, #3
12. COLLECTOR, #3
13. COLLECTOR, #4
14. BASE, #4
15. EMITTER, #4
16. COLLECTOR, #4</p> | <p>STYLE 4:</p> <p>PIN 1. COLLECTOR, DYE #1
2. COLLECTOR, #1
3. COLLECTOR, #2
4. COLLECTOR, #2
5. COLLECTOR, #3
6. COLLECTOR, #3
7. COLLECTOR, #4
8. COLLECTOR, #4
9. BASE, #4
10. EMITTER, #4
11. BASE, #3
12. EMITTER, #3
13. BASE, #2
14. EMITTER, #2
15. BASE, #1
16. EMITTER, #1</p> |
| <p>STYLE 5:</p> <p>PIN 1. DRAIN, DYE #1
2. DRAIN, #1
3. DRAIN, #2
4. DRAIN, #2
5. DRAIN, #3
6. DRAIN, #3
7. DRAIN, #4
8. DRAIN, #4
9. GATE, #4
10. SOURCE, #4
11. GATE, #3
12. SOURCE, #3
13. GATE, #2
14. SOURCE, #2
15. GATE, #1
16. SOURCE, #1</p> | <p>STYLE 6:</p> <p>PIN 1. CATHODE
2. CATHODE
3. CATHODE
4. CATHODE
5. CATHODE
6. CATHODE
7. CATHODE
8. CATHODE
9. ANODE
10. ANODE
11. ANODE
12. ANODE
13. ANODE
14. ANODE
15. ANODE
16. ANODE</p> | <p>STYLE 7:</p> <p>PIN 1. SOURCE N-CH
2. COMMON DRAIN (OUTPUT)
3. COMMON DRAIN (OUTPUT)
4. GATE P-CH
5. COMMON DRAIN (OUTPUT)
6. COMMON DRAIN (OUTPUT)
7. COMMON DRAIN (OUTPUT)
8. SOURCE P-CH
9. SOURCE P-CH
10. COMMON DRAIN (OUTPUT)
11. COMMON DRAIN (OUTPUT)
12. COMMON DRAIN (OUTPUT)
13. GATE N-CH
14. COMMON DRAIN (OUTPUT)
15. COMMON DRAIN (OUTPUT)
16. SOURCE N-CH</p> | |

SOLDERING FOOTPRINT



DIMENSIONS: MILLIMETERS

DOCUMENT NUMBER:	98ASB42566B	Electronic versions are uncontrolled except when accessed directly from the Document Repository. Printed versions are uncontrolled except when stamped "CONTROLLED COPY" in red.
DESCRIPTION:	SOIC-16	PAGE 1 OF 1

ON Semiconductor and are trademarks of Semiconductor Components Industries, LLC dba ON Semiconductor or its subsidiaries in the United States and/or other countries. ON Semiconductor reserves the right to make changes without further notice to any products herein. ON Semiconductor makes no warranty, representation or guarantee regarding the suitability of its products for any particular purpose, nor does ON Semiconductor assume any liability arising out of the application or use of any product or circuit, and specifically disclaims any and all liability, including without limitation special, consequential or incidental damages. ON Semiconductor does not convey any license under its patent rights nor the rights of others.

MECHANICAL CASE OUTLINE

PACKAGE DIMENSIONS

ON Semiconductor®

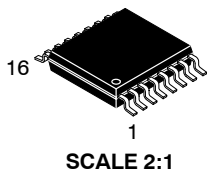

TSSOP-16
CASE 948F-01
ISSUE B

DATE 19 OCT 2006

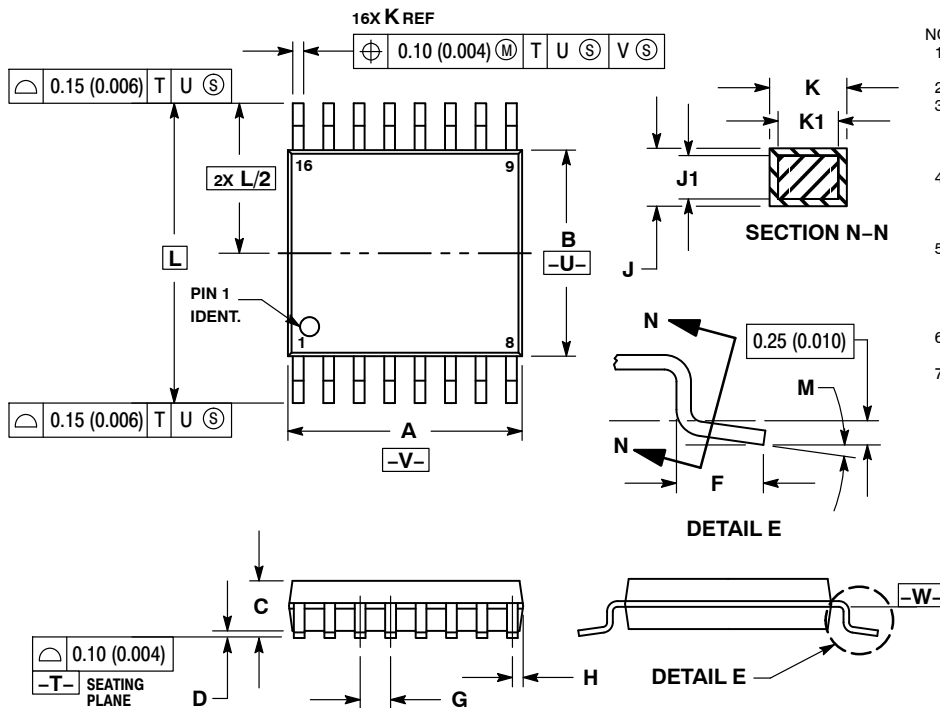

NOTES:

1. DIMENSIONING AND TOLERANCING PER ANSI Y14.5M, 1982.
2. CONTROLLING DIMENSION: MILLIMETER.
3. DIMENSION A DOES NOT INCLUDE MOLD FLASH. PROTRUSIONS OR GATE BURRS. MOLD FLASH OR GATE BURRS SHALL NOT EXCEED 0.15 (0.006) PER SIDE.
4. DIMENSION B DOES NOT INCLUDE INTERLEAD FLASH OR PROTRUSION. INTERLEAD FLASH OR PROTRUSION SHALL NOT EXCEED 0.25 (0.010) PER SIDE.
5. DIMENSION K DOES NOT INCLUDE DAMBAR PROTRUSION. ALLOWABLE DAMBAR PROTRUSION SHALL BE 0.08 (0.003) TOTAL IN EXCESS OF THE K DIMENSION AT MAXIMUM MATERIAL CONDITION.
6. TERMINAL NUMBERS ARE SHOWN FOR REFERENCE ONLY.
7. DIMENSION A AND B ARE TO BE DETERMINED AT DATUM PLANE -W-.

DIM	MILLIMETERS		INCHES	
	MIN	MAX	MIN	MAX
A	4.90	5.10	0.193	0.200
B	4.30	4.50	0.169	0.177
C	---	1.20	---	0.047
D	0.05	0.15	0.002	0.006
F	0.50	0.75	0.020	0.030
G	0.65 BSC		0.026 BSC	
H	0.18	0.28	0.007	0.011
J	0.09	0.20	0.004	0.008
J1	0.09	0.16	0.004	0.006
K	0.19	0.30	0.007	0.012
K1	0.19	0.25	0.007	0.010
L	6.40 BSC		0.252 BSC	
M	0°	8°	0°	8°

SOLDERING FOOTPRINT

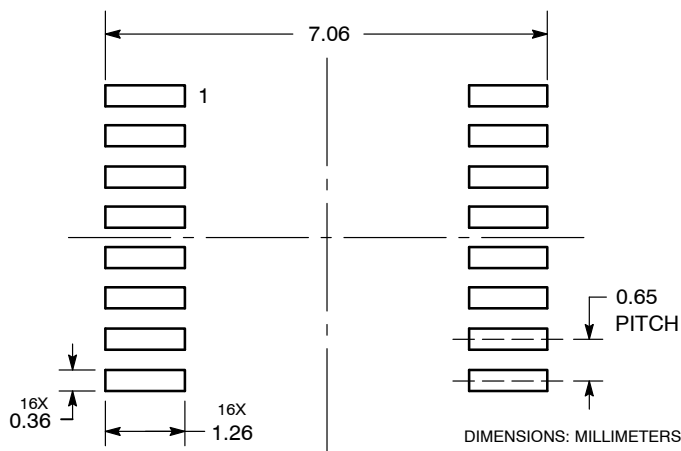

GENERIC MARKING DIAGRAM*

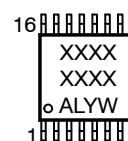

- XXXX = Specific Device Code
- A = Assembly Location
- L = Wafer Lot
- Y = Year
- W = Work Week
- G or ■ = Pb-Free Package

*This information is generic. Please refer to device data sheet for actual part marking. Pb-Free indicator, "G" or microdot "■", may or may not be present.

DOCUMENT NUMBER:	98ASH70247A	Electronic versions are uncontrolled except when accessed directly from the Document Repository. Printed versions are uncontrolled except when stamped "CONTROLLED COPY" in red.
DESCRIPTION:	TSSOP-16	PAGE 1 OF 1

ON Semiconductor and ON are trademarks of Semiconductor Components Industries, LLC dba ON Semiconductor or its subsidiaries in the United States and/or other countries. ON Semiconductor reserves the right to make changes without further notice to any products herein. ON Semiconductor makes no warranty, representation or guarantee regarding the suitability of its products for any particular purpose, nor does ON Semiconductor assume any liability arising out of the application or use of any product or circuit, and specifically disclaims any and all liability, including without limitation special, consequential or incidental damages. ON Semiconductor does not convey any license under its patent rights nor the rights of others.

onsemi, **Onsemi**, and other names, marks, and brands are registered and/or common law trademarks of Semiconductor Components Industries, LLC dba "**onsemi**" or its affiliates and/or subsidiaries in the United States and/or other countries. **onsemi** owns the rights to a number of patents, trademarks, copyrights, trade secrets, and other intellectual property. A listing of **onsemi**'s product/patent coverage may be accessed at www.onsemi.com/site/pdf/Patent-Marking.pdf. **onsemi** reserves the right to make changes at any time to any products or information herein, without notice. The information herein is provided "as-is" and **onsemi** makes no warranty, representation or guarantee regarding the accuracy of the information, product features, availability, functionality, or suitability of its products for any particular purpose, nor does **onsemi** assume any liability arising out of the application or use of any product or circuit, and specifically disclaims any and all liability, including without limitation special, consequential or incidental damages. Buyer is responsible for its products and applications using **onsemi** products, including compliance with all laws, regulations and safety requirements or standards, regardless of any support or applications information provided by **onsemi**. "Typical" parameters which may be provided in **onsemi** data sheets and/or specifications can and do vary in different applications and actual performance may vary over time. All operating parameters, including "Typicals" must be validated for each customer application by customer's technical experts. **onsemi** does not convey any license under any of its intellectual property rights nor the rights of others. **onsemi** products are not designed, intended, or authorized for use as a critical component in life support systems or any FDA Class 3 medical devices or medical devices with a same or similar classification in a foreign jurisdiction or any devices intended for implantation in the human body. Should Buyer purchase or use **onsemi** products for any such unintended or unauthorized application, Buyer shall indemnify and hold **onsemi** and its officers, employees, subsidiaries, affiliates, and distributors harmless against all claims, costs, damages, and expenses, and reasonable attorney fees arising out of, directly or indirectly, any claim of personal injury or death associated with such unintended or unauthorized use, even if such claim alleges that **onsemi** was negligent regarding the design or manufacture of the part. **onsemi** is an Equal Opportunity/Affirmative Action Employer. This literature is subject to all applicable copyright laws and is not for resale in any manner.

PUBLICATION ORDERING INFORMATION

LITERATURE FULFILLMENT:

Email Requests to: orderlit@onsemi.com

onsemi Website: www.onsemi.com

TECHNICAL SUPPORT

North American Technical Support:

Voice Mail: 1 800-282-9855 Toll Free USA/Canada

Phone: 011 421 33 790 2910

Europe, Middle East and Africa Technical Support:

Phone: 00421 33 790 2910

For additional information, please contact your local Sales Representative

