

Low clamping and low capacitance bidirectional single line ESD protection

Datasheet - production data

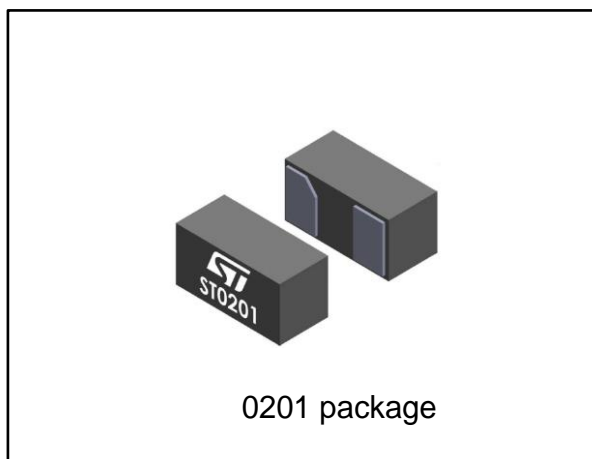

Features

- Low clamping voltage
- Bidirectional device
- Low leakage current
- 0201 package
- Ultra low PCB area: 0.18 mm²
- ECOPACK®2 compliant component
- Exceeds the following standard:
 - IEC 61000-4-2 level 4 = ±15 kV (air discharge) and ±8 kV (contact discharge)

Applications

Where transient over voltage protection in ESD sensitive equipment is required, such as:

- Smartphones, mobile phones and accessories
- Tablets and notebooks
- Portable multimedia devices and accessories
- Wearable, home automation, healthcare
- Highly integrated systems

Description

The ESDALC5-1BF4 is a bidirectional single line TVS diode designed to protect the data line or other I/O ports against ESD transients.

The device is ideal for applications where both reduced line capacitance and board space saving are required.

Figure 1: Functional diagram

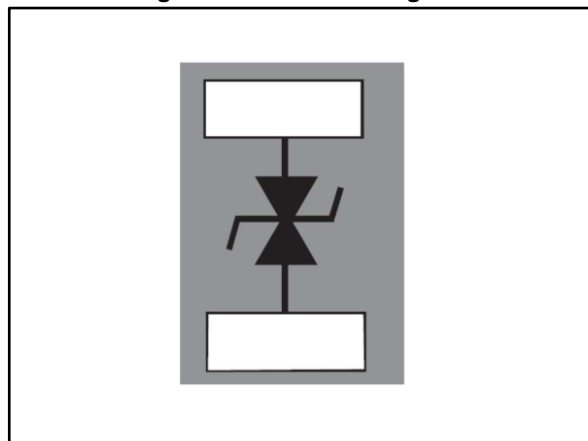

1 Characteristics

Table 1: Absolute maximum ratings

Symbol	Parameter	Value	Unit
V _{PP}	Peak pulse voltage	Contact discharge	16
		Air discharge	30
P _{PP}	Peak pulse power dissipation (8/20 μs)	28	W
I _{PP}	Peak pulse current (8/20 μs)	2.5	A
T _j	Operating junction temperature range	-40 to +150	°C
T _{stg}	Storage temperature range	-65 to +150	°C
T _L	Maximum lead temperature for soldering during 10 s	260	°C

Figure 2: Electrical characteristics (definitions)

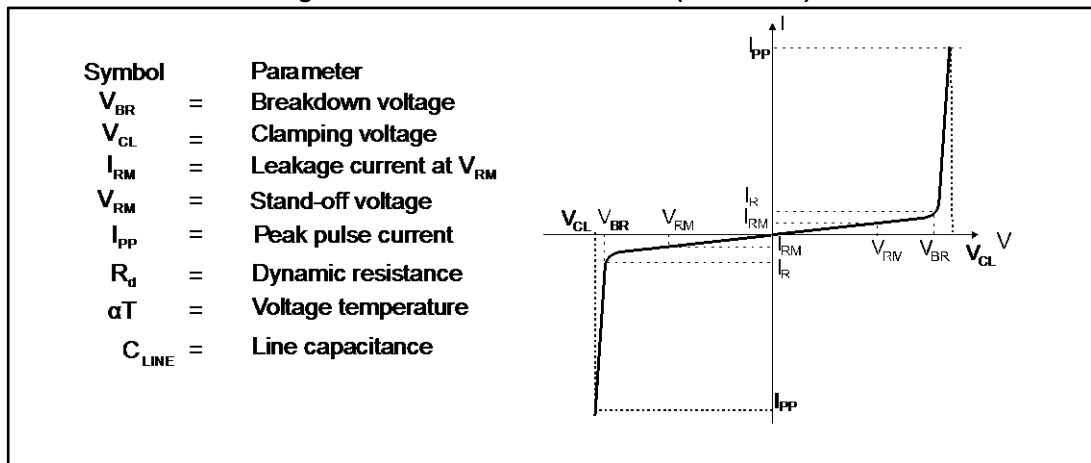
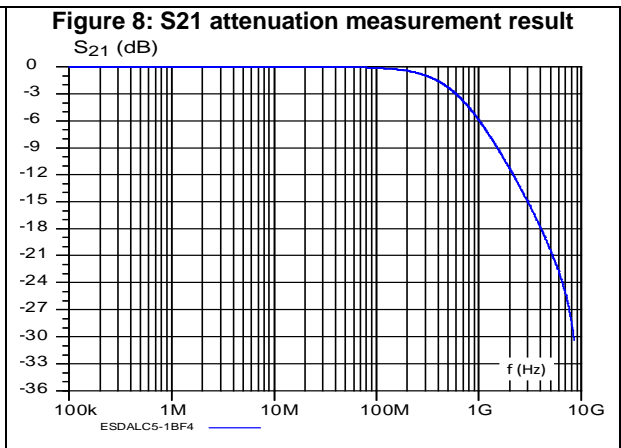
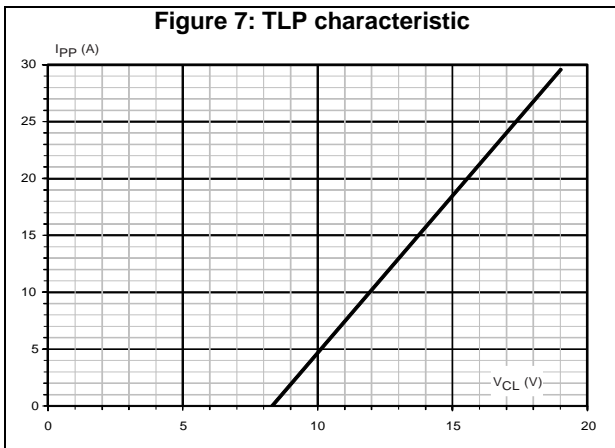
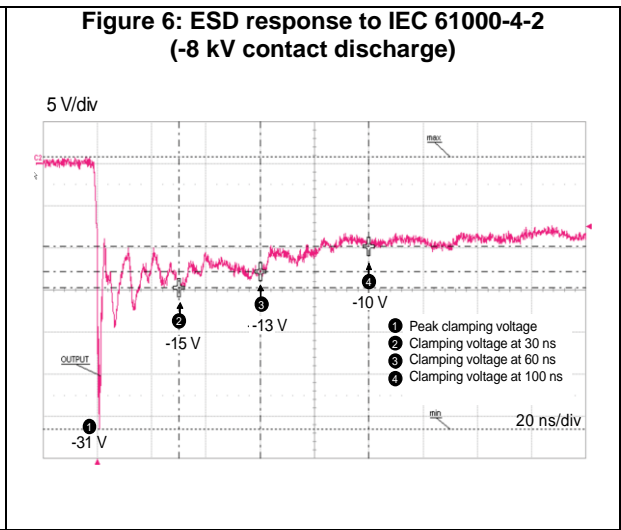
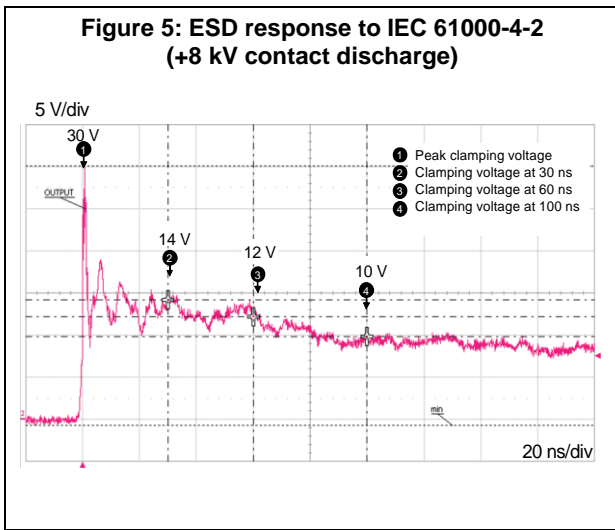
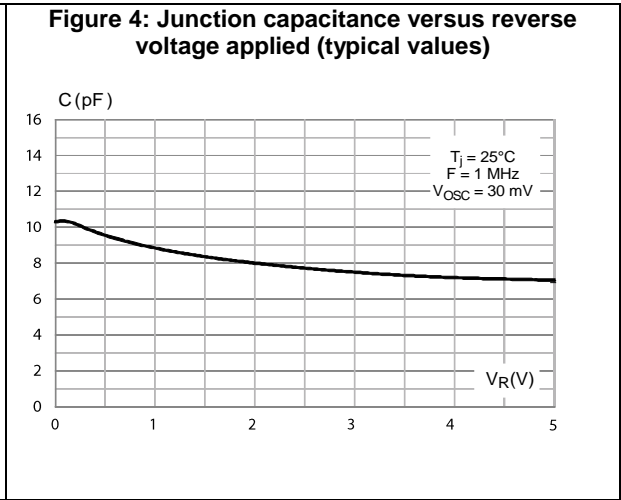
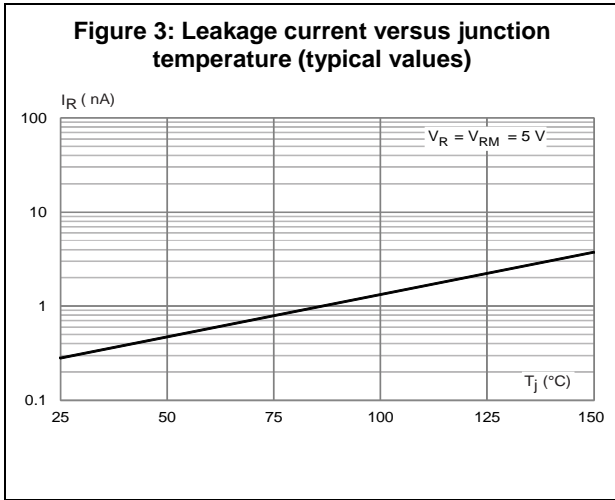

Table 2: Electrical characteristics (T_{amb} = 25 °C)

Symbol	Parameter	Min.	Typ.	Max.	Unit
V _{BR}	I _R = 1 mA	5.8			kV
I _{RM}	V _{RM} = 5 V			100	nA
C _{LINE}	F = 1 MHz, V _{LINE} = 0 V, V _{OSC} = 30 mV		10	12	pF



2 Package information

In order to meet environmental requirements, ST offers these devices in different grades of ECOPACK® packages, depending on their level of environmental compliance. ECOPACK® specifications, grade definitions and product status are available at: www.st.com. ECOPACK® is an ST trademark.

2.1 0201 package information

Figure 9: 0201 package outline

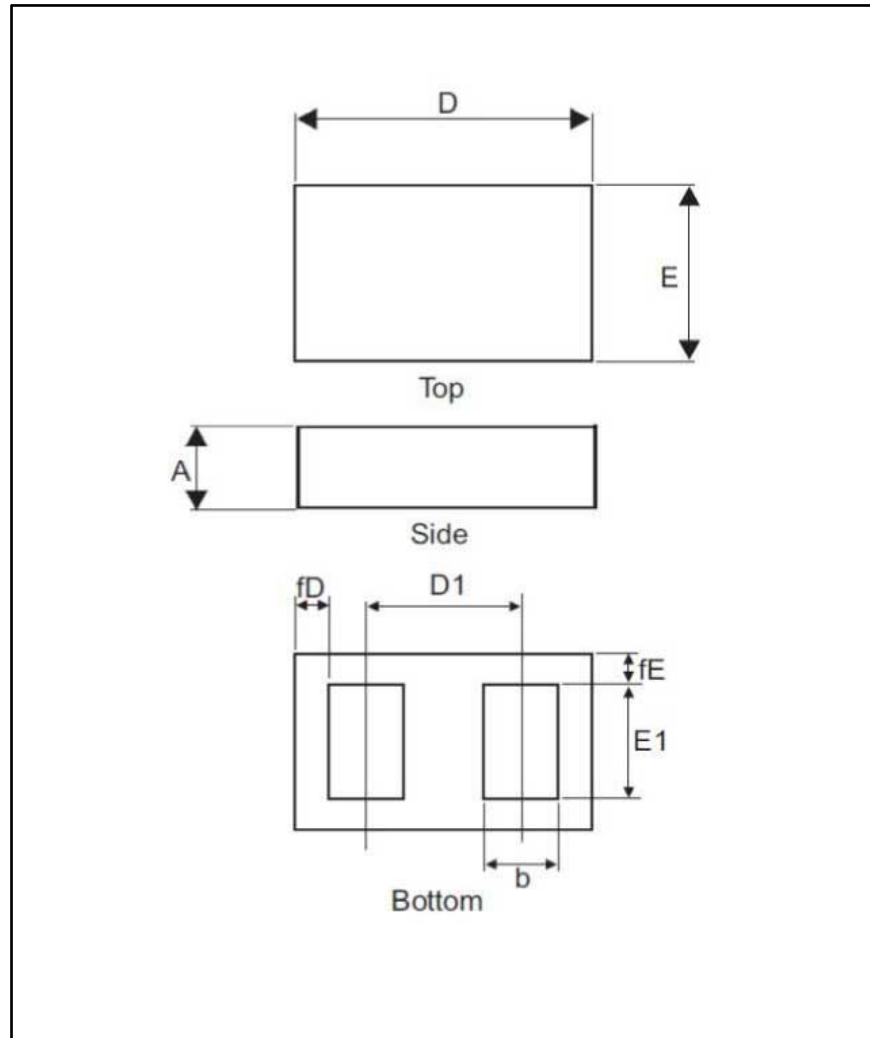

The marking codes can be rotated by 90° or 180° to differentiate assembly location. In no case should this product marking be used to orient the component for its placement on a PCB. Only pin 1 mark is to be used for this purpose.

Table 3: 0201 package mechanical data

Ref.	Dimensions		
	Millimeters		
	Min.	Typ.	Max.
A	0.280	0.300	0.320
b	0.125	0.140	0.155
D	0.570	0.600	0.630
D1		0.350	
E	0.270	0.300	0.330
E1	0.175	0.190	0.205
fD	0.110	0.125	0.140
fE	0.040	0.055	0.070

Figure 10: Marking

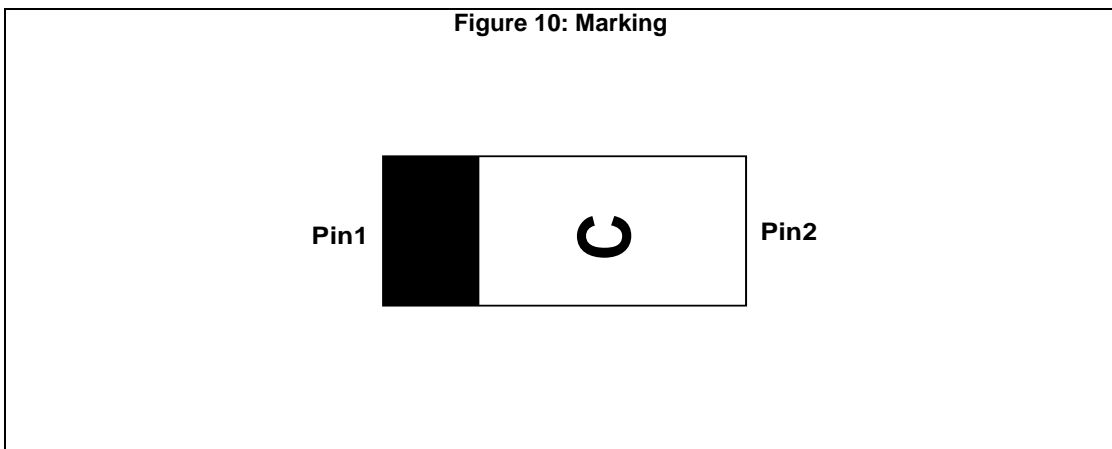

The marking codes can be rotated by 90° or 180° to differentiate assembly location. In no case should this product marking be used to orient the component for its placement on a PCB. Only pin 1 mark is to be used for this purpose.

Figure 11: Tape and reel specification (in mm)

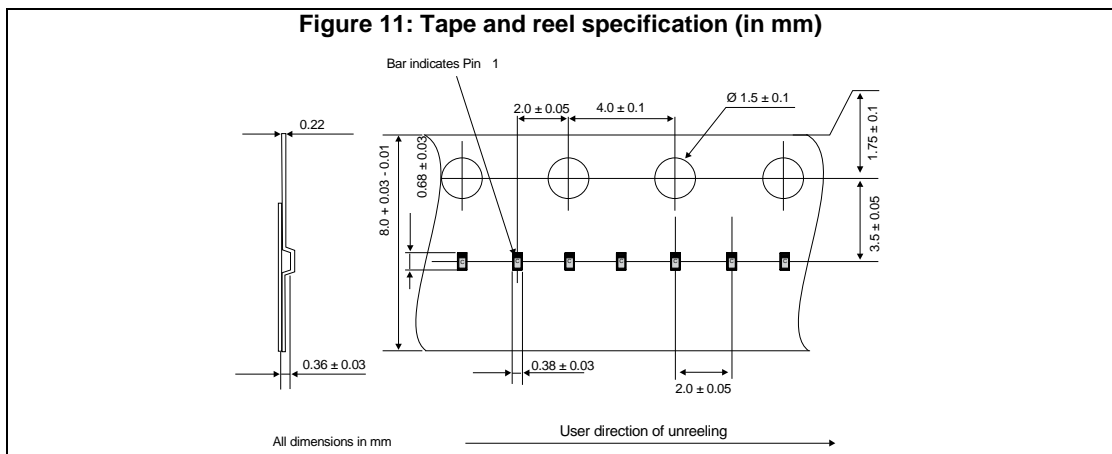

3 Recommendation on PCB assembly

3.1 Footprint

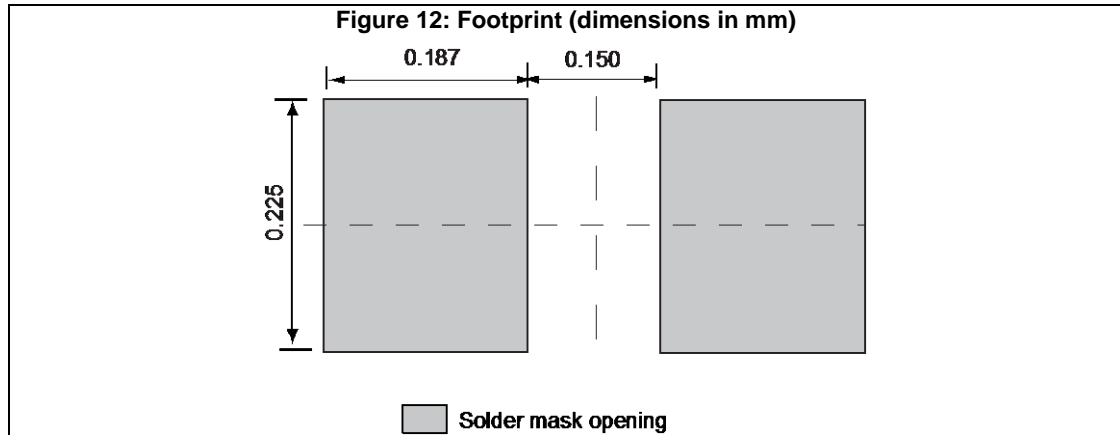

1. SMD footprint design is recommended.

3.2 Stencil opening design

1. Recommended design reference
 - a. Stencil opening thickness: 75 μm / 3 mils

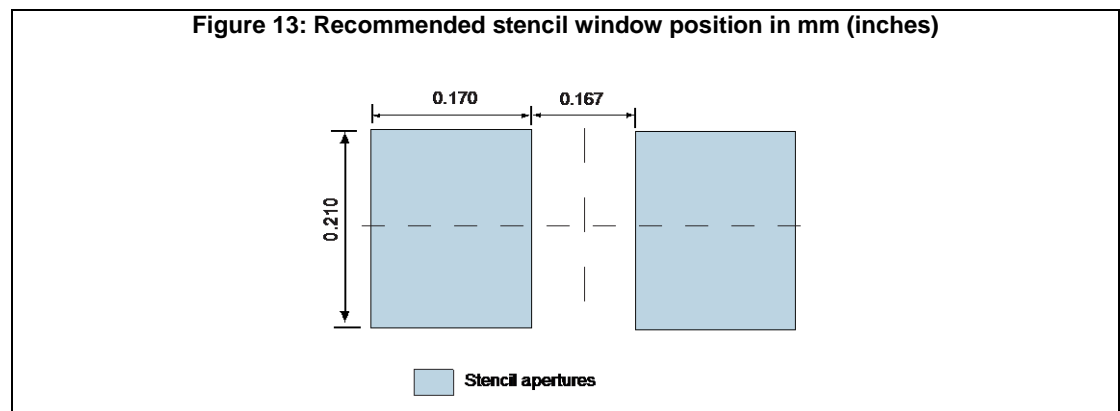

3.3 Solder paste

1. Halide-free flux qualification ROL0 according to ANSI/J-STD-004.
2. "No clean" solder paste is recommended.
3. Offers a high tack force to resist component movement during high speed.
4. Use solder paste with particle size 20-38 μm

3.4 Placement

1. Manual positioning is not recommended.
2. It is recommended to use the lead recognition capabilities of the placement system, not the outline centering
3. Standard tolerance of ± 0.05 mm is recommended.
4. 1.0 N placement force is recommended. Too much placement force can lead to squeezed out solder paste and cause solder joints to short. Too low placement force can lead to insufficient contact between package and solder paste that could cause open solder joints or badly centered packages.
5. To improve the package placement accuracy, a bottom side optical control should be performed with a high resolution tool.
6. For assembly, a perfect supporting of the PCB (all the more on flexible PCB) is recommended during solder paste printing, pick and place and reflow soldering by using optimized tools.

3.5 PCB design preference

1. To control the solder paste amount, the closed via is recommended instead of open vias.
2. The position of tracks and open vias in the solder area should be well balanced. A symmetrical layout is recommended, to avoid any tilt phenomena caused by asymmetrical solder paste due to solder flow away.

3.6 Reflow profile

Figure 14: ST ECOPACK® recommended soldering reflow profile for PCB mounting

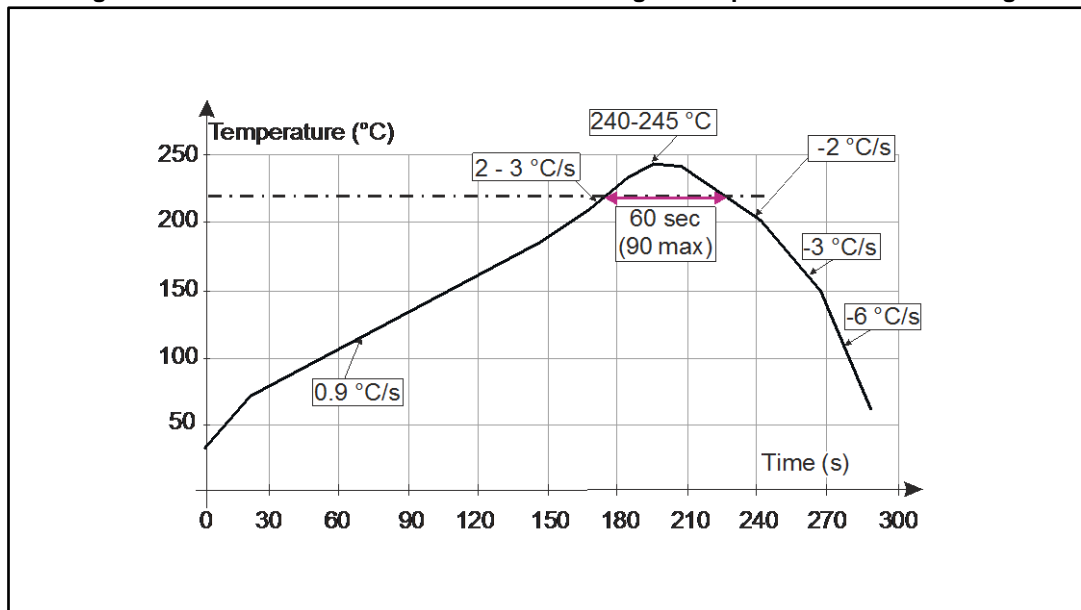

Minimize air convection currents in the reflow oven to avoid component movement.

4 Ordering information

Figure 15: Ordering information scheme

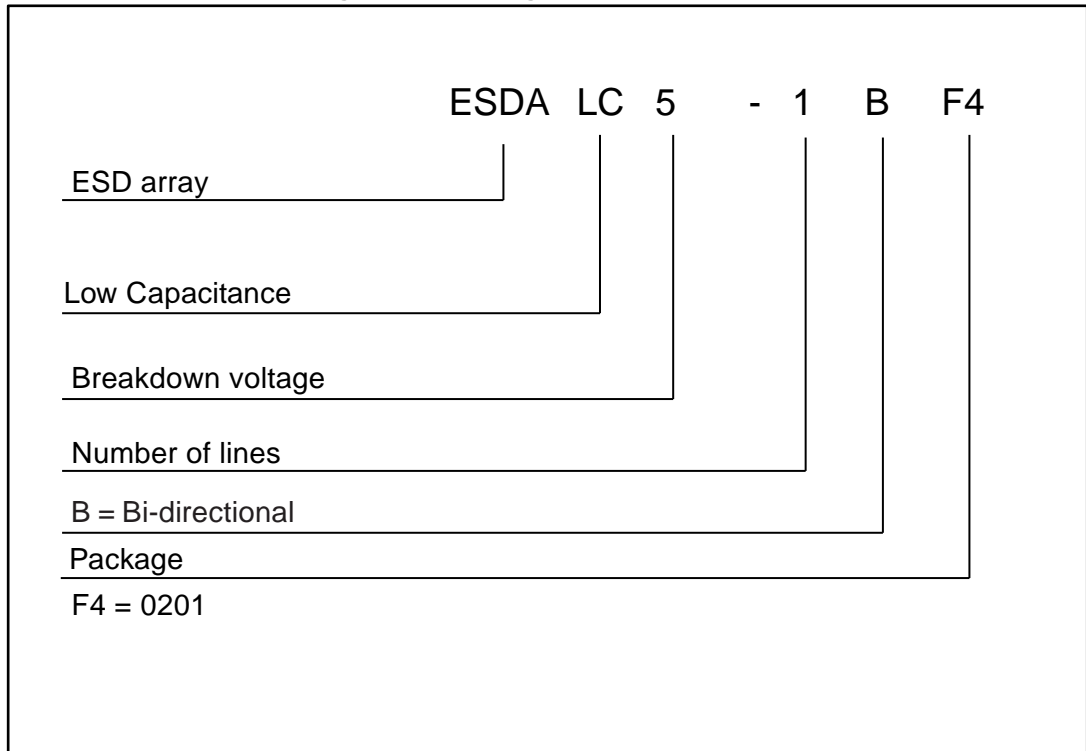

Table 4: Ordering information

Order code	Marking	Package	Weight	Base qty.	Delivery mode
ESDALC5-1BF4	C ⁽¹⁾	0201	0.116 mg	15000	Tape and reel

Notes:

⁽¹⁾The marking can be rotated by multiples of 90° to differentiate assembly location.

5 Revision history

Table 5: Document revision history

Date	Revision	Changes
06-Feb-2014	1	First issue.
01-Jun-2017	2	Updated Table 3: "0201 package mechanical data" . Updated Section 3.2: "Stencil opening design" .

IMPORTANT NOTICE – PLEASE READ CAREFULLY

STMicroelectronics NV and its subsidiaries ("ST") reserve the right to make changes, corrections, enhancements, modifications, and improvements to ST products and/or to this document at any time without notice. Purchasers should obtain the latest relevant information on ST products before placing orders. ST products are sold pursuant to ST's terms and conditions of sale in place at the time of order acknowledgement.

Purchasers are solely responsible for the choice, selection, and use of ST products and ST assumes no liability for application assistance or the design of Purchasers' products.

No license, express or implied, to any intellectual property right is granted by ST herein.

Resale of ST products with provisions different from the information set forth herein shall void any warranty granted by ST for such product.

ST and the ST logo are trademarks of ST. All other product or service names are the property of their respective owners.

Information in this document supersedes and replaces information previously supplied in any prior versions of this document.

© 2017 STMicroelectronics – All rights reserved