



Is Now Part of



ON Semiconductor®

To learn more about ON Semiconductor, please visit our website at
www.onsemi.com

Please note: As part of the Fairchild Semiconductor integration, some of the Fairchild orderable part numbers will need to change in order to meet ON Semiconductor's system requirements. Since the ON Semiconductor product management systems do not have the ability to manage part nomenclature that utilizes an underscore (_), the underscore (_) in the Fairchild part numbers will be changed to a dash (-). This document may contain device numbers with an underscore (_). Please check the ON Semiconductor website to verify the updated device numbers. The most current and up-to-date ordering information can be found at www.onsemi.com. Please email any questions regarding the system integration to Fairchild_questions@onsemi.com.

ON Semiconductor and the ON Semiconductor logo are trademarks of Semiconductor Components Industries, LLC dba ON Semiconductor or its subsidiaries in the United States and/or other countries. ON Semiconductor owns the rights to a number of patents, trademarks, copyrights, trade secrets, and other intellectual property. A listing of ON Semiconductor's product/patent coverage may be accessed at www.onsemi.com/site/pdf/Patent-Marking.pdf. ON Semiconductor reserves the right to make changes without further notice to any products herein. ON Semiconductor makes no warranty, representation or guarantee regarding the suitability of its products for any particular purpose, nor does ON Semiconductor assume any liability arising out of the application or use of any product or circuit, and specifically disclaims any and all liability, including without limitation special, consequential or incidental damages. Buyer is responsible for its products and applications using ON Semiconductor products, including compliance with all laws, regulations and safety requirements or standards, regardless of any support or applications information provided by ON Semiconductor. "Typical" parameters which may be provided in ON Semiconductor data sheets and/or specifications can and do vary in different applications and actual performance may vary over time. All operating parameters, including "Typicals" must be validated for each customer application by customer's technical experts. ON Semiconductor does not convey any license under its patent rights nor the rights of others. ON Semiconductor products are not designed, intended, or authorized for use as a critical component in life support systems or any FDA Class 3 medical devices or medical devices with a same or similar classification in a foreign jurisdiction or any devices intended for implantation in the human body. Should Buyer purchase or use ON Semiconductor products for any such unintended or unauthorized application, Buyer shall indemnify and hold ON Semiconductor and its officers, employees, subsidiaries, affiliates, and distributors harmless against all claims, costs, damages, and expenses, and reasonable attorney fees arising out of, directly or indirectly, any claim of personal injury or death associated with such unintended or unauthorized use, even if such claim alleges that ON Semiconductor was negligent regarding the design or manufacture of the part. ON Semiconductor is an Equal Opportunity/Affirmative Action Employer. This literature is subject to all applicable copyright laws and is not for resale in any manner.

100315 Low Skew Quad Clock Driver

General Description

The 100315 contains four low skew differential drivers, designed for generation of multiple, minimum skew differential clocks from a single differential input. This device also has the capability to select a secondary single-ended clock source for use in lower frequency system level testing. The 100315 is a 300 Series redesign of the 100115 clock driver.

Features

- Low output-to-output skew (≤ 50 ps)
- Differential inputs and outputs
- Secondary clock available for system level testing
- 2000V ESD protection
- Voltage compensated operating range: $-4.2V$ to $-5.7V$

Ordering Code:

Order Number	Package Number	Package Descriptions
100315SC	M16A	16-Lead Small Outline Integrated Circuit (SOIC), JEDEC MS-012, 0.150 Narrow

Devices also available in Tape and Reel. Specify by appending the suffix letter "X" to the ordering code.

Logic Diagram

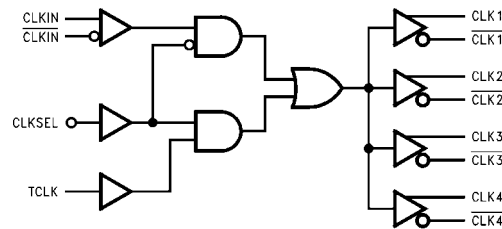

Connection Diagram

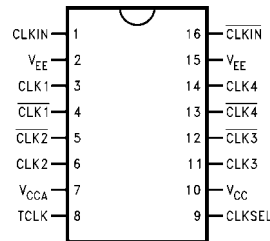

Pin Descriptions

Pin Names	Description
CLKIN, CLKIN-bar	Differential Clock Inputs
CLK ₁₋₄ , CLK ₁₋₄ -bar	Differential Clock Outputs
TCLK	Test Clock Input (Note 1)
CLKSEL	Clock Input Select (Note 1)

Note 1: TCLK and CLKSEL are single-ended inputs, with internal 50 k Ω pull-down resistors.

Truth Table

CLKSEL	CLKIN	CLKIN-bar	TCLK	CLK _n	CLK _n -bar
L	L	H	X	L	H
L	H	L	X	H	L
H	X	X	L	L	H
H	X	X	H	H	L

L = LOW Voltage Level
H = HIGH Voltage Level
X = Don't Care

Absolute Maximum Ratings (Note 2)

Storage Temperature	-65°C to +150°C
Maximum Junction Temperature (T _J)	+150°C
Case Temperature under Bias (T _C)	0°C to +85°C
V _{EE} Pin Potential to Ground Pin	-7.0V to +0.5V
Input Voltage (DC)	V _{CC} to +0.5V
Output Current (DC Output HIGH)	-50 mA
Operating Range (Note 2)	-5.7V to -4.2V
ESD (Note 3)	≥2000V

Recommended Operating Conditions

Case Temperature (T _C)	0°C to +85°C
Supply Voltage (V _{EE})	-5.7V to -4.2V

Note 2: The "Absolute Maximum Ratings" are those values beyond which the safety of the device cannot be guaranteed. The device should not be operated at these limits. The parametric values defined in the Electrical Characteristics tables are not guaranteed at the absolute maximum rating. The "Recommended Operating Conditions" table will define the conditions for actual device operation.

Note 3: ESD testing conforms to MIL-STD-883, Method 3015.

DC Electrical Characteristics (Note 4)

V_{EE} = -4.2V to -5.7V, V_{CC} = V_{CCA} = GND, T_C = 0°C to +85°C

Symbol	Parameter	Min	Typ	Max	Units	Conditions
V _{OH}	Output HIGH Voltage	-1025	-955	-870	mV	V _{IN} = V _{IH(Max)} Loading with 50Ω to -2.0V
V _{OL}	Output LOW Voltage	-1830	-1705	-1620		V _{IN} = V _{IL(Min)}
V _{OHC}	Output HIGH Voltage	-1035			mV	V _{IN} = V _{IH(Min)} Loading with 50Ω to -2.0V
V _{OLC}	Output LOW Voltage			-1610		V _{IN} = V _{IL(Max)}
V _{IH}	Single-Ended Input HIGH Voltage	-1165		-870	mV	Guaranteed HIGH Signal for All Inputs
V _{IL}	Single-Ended Input LOW Voltage	-1830		-1475	mV	Guaranteed LOW Signal for All Inputs
I _{IL}	Input LOW Current	0.50			μA	V _{IN} = V _{IL(Min)}
I _{IH}	Input HIGH Current CLKIN, CLKIN TCLK CLKSEL			150 250 250	μA μA μA	V _{IN} = V _{IH(Max)}
V _{DIFF}	Input Voltage Differential	150			mV	Required for Full Output Swing
V _{CM}	Common Mode Voltage	V _{CC} - 2V		V _{CC} - 0.5V	V	
I _{CBO}	Input Leakage Current	-10			μA	V _{IN} = V _{EE}
I _{EE}	Power Supply Current	-67		-35	mA	

Note 4: The specified limits represent the "worst case" value for the parameter. Since these "worst case" values normally occur at the temperature extremes, additional noise immunity and guard banding can be achieved by decreasing the allowable system operating ranges.

AC Electrical Characteristics

V_{EE} = -4.2V to -4.8, V_{CC} = V_{CCA} = GND

Symbol	Parameter	T _C = 0°C		T _C = +25°C		T _C = +85°C		Units	Conditions
		Min	Max	Min	Max	Min	Max		
f _{MAX}	Maximum Clock Frequency	750		750		750		MHz	
t _{PLH} t _{PHL}	Propagation Delay CLKIN, CLKIN to CLK ₍₁₋₄₎ , CLK ₍₁₋₄₎							ns	Figures 1, 3
	Differential	0.59	0.79	0.62	0.82	0.67	0.87		
	Single-Ended	0.59	0.99	0.62	1.02	0.67	1.07		
t _{PLH} t _{PHL}	Propagation Delay, TCLK to CLK ₍₁₋₄₎ , CLK ₍₁₋₄₎	0.50	1.20	0.50	1.20	0.50	1.20	ns	Figures 1, 2
t _{PLH} t _{PHL}	Propagation Delay, CLKSEL to CLK ₍₁₋₄₎ , CLK ₍₁₋₄₎	0.80	1.60	0.80	1.60	0.80	1.60	ns	Figures 1, 2
t _{TLH} t _{THL}	Transition Time 20% to 80%, 80% to 20%	0.30	0.80	0.30	0.80	0.30	0.80	ns	Figures 1, 4
t _{OST} DIFF	Maximum Skew Opposite Edge Output-to-Output Variation Data to Output Path		50		50		50	ps	(Note 5)

Note 5: Output-to-Output Skew is defined as the absolute value of the difference between the actual propagation delay for any outputs within the same packaged device. The specifications apply to any outputs switching in the same direction either HIGH-to-LOW (t_{OSHL}), or LOW-to-HIGH (t_{OSLH}), or in opposite directions both HL and LH (t_{OST}). Parameters t_{OST} and t_{PS} guaranteed by design.

Test Circuit

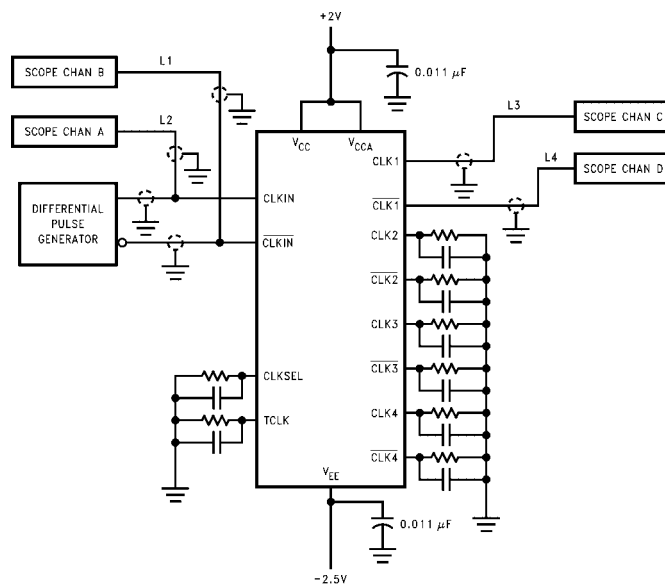

Note:

Shown for testing CLKIN to CLK1 in the differential mode.

L1, L2, L3 and L4 = equal length 50Ω impedance lines.

All unused inputs and outputs are loaded with 50Ω in parallel with ≤ 3 pF to GND.

Scope should have 50Ω input terminator internally.

FIGURE 1. AC Test Circuit

Switching Waveforms

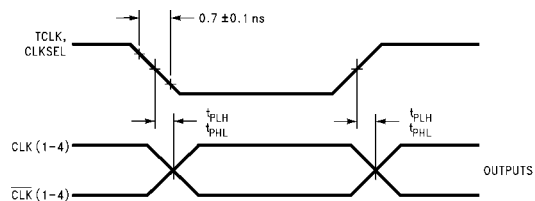

FIGURE 2. Propagation Delay, TCLK, CLKSEL to Outputs

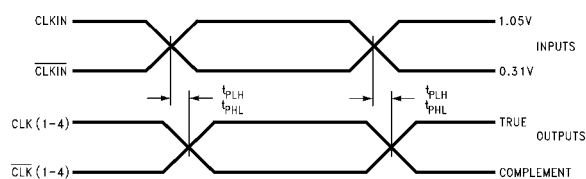

FIGURE 3. Propagation Delay, CLKIN/CLKIN to Outputs

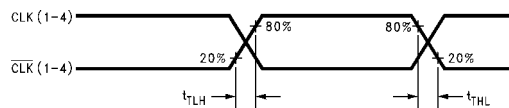
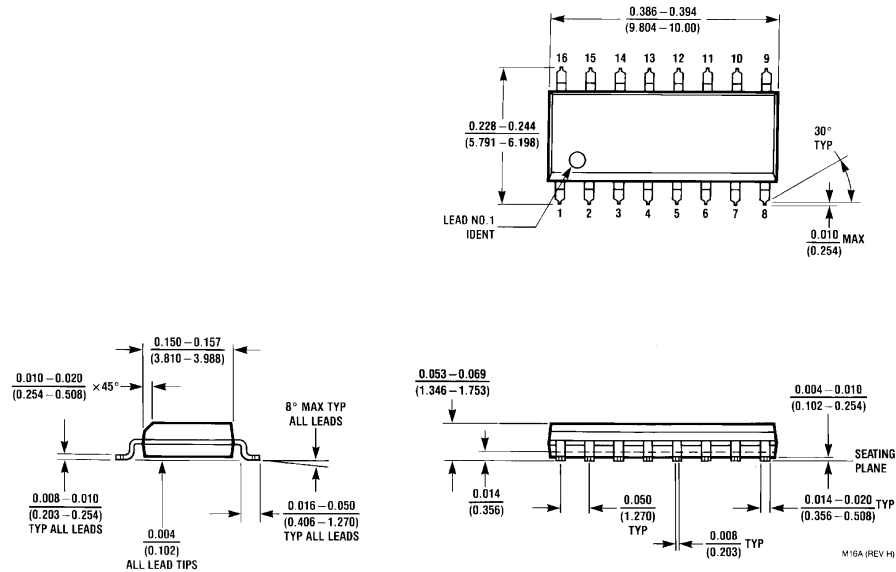

FIGURE 4. Transition Times

Physical Dimensions inches (millimeters) unless otherwise noted



16-Lead Small Outline Integrated Circuit (SOIC), JEDEC MS-012, 0.150 Narrow Package Number M16A

Fairchild does not assume any responsibility for use of any circuitry described, no circuit patent licenses are implied and Fairchild reserves the right at any time without notice to change said circuitry and specifications.

LIFE SUPPORT POLICY

FAIRCHILD'S PRODUCTS ARE NOT AUTHORIZED FOR USE AS CRITICAL COMPONENTS IN LIFE SUPPORT DEVICES OR SYSTEMS WITHOUT THE EXPRESS WRITTEN APPROVAL OF THE PRESIDENT OF FAIRCHILD SEMICONDUCTOR CORPORATION. As used herein:

1. Life support devices or systems are devices or systems which, (a) are intended for surgical implant into the body, or (b) support or sustain life, and (c) whose failure to perform when properly used in accordance with instructions for use provided in the labeling, can be reasonably expected to result in a significant injury to the user.
2. A critical component in any component of a life support device or system whose failure to perform can be reasonably expected to cause the failure of the life support device or system, or to affect its safety or effectiveness.

www.fairchildsemi.com

ON Semiconductor and  are trademarks of Semiconductor Components Industries, LLC dba ON Semiconductor or its subsidiaries in the United States and/or other countries. ON Semiconductor owns the rights to a number of patents, trademarks, copyrights, trade secrets, and other intellectual property. A listing of ON Semiconductor's product/patent coverage may be accessed at www.onsemi.com/site/pdf/Patent-Marking.pdf. ON Semiconductor reserves the right to make changes without further notice to any products herein. ON Semiconductor makes no warranty, representation or guarantee regarding the suitability of its products for any particular purpose, nor does ON Semiconductor assume any liability arising out of the application or use of any product or circuit, and specifically disclaims any and all liability, including without limitation special, consequential or incidental damages. Buyer is responsible for its products and applications using ON Semiconductor products, including compliance with all laws, regulations and safety requirements or standards, regardless of any support or applications information provided by ON Semiconductor. "Typical" parameters which may be provided in ON Semiconductor data sheets and/or specifications can and do vary in different applications and actual performance may vary over time. All operating parameters, including "Typicals" must be validated for each customer application by customer's technical experts. ON Semiconductor does not convey any license under its patent rights nor the rights of others. ON Semiconductor products are not designed, intended, or authorized for use as a critical component in life support systems or any FDA Class 3 medical devices or medical devices with a same or similar classification in a foreign jurisdiction or any devices intended for implantation in the human body. Should Buyer purchase or use ON Semiconductor products for any such unintended or unauthorized application, Buyer shall indemnify and hold ON Semiconductor and its officers, employees, subsidiaries, affiliates, and distributors harmless against all claims, costs, damages, and expenses, and reasonable attorney fees arising out of, directly or indirectly, any claim of personal injury or death associated with such unintended or unauthorized use, even if such claim alleges that ON Semiconductor was negligent regarding the design or manufacture of the part. ON Semiconductor is an Equal Opportunity/Affirmative Action Employer. This literature is subject to all applicable copyright laws and is not for resale in any manner.

PUBLICATION ORDERING INFORMATION

LITERATURE FULFILLMENT:

Literature Distribution Center for ON Semiconductor
19521 E. 32nd Pkwy, Aurora, Colorado 80011 USA
Phone: 303-675-2175 or 800-344-3860 Toll Free USA/Canada
Fax: 303-675-2176 or 800-344-3867 Toll Free USA/Canada
Email: orderlit@onsemi.com

N. American Technical Support: 800-282-9855 Toll Free
USA/Canada
Europe, Middle East and Africa Technical Support:
Phone: 421 33 790 2910
Japan Customer Focus Center
Phone: 81-3-5817-1050

ON Semiconductor Website: www.onsemi.com
Order Literature: <http://www.onsemi.com/orderlit>
For additional information, please contact your local
Sales Representative