

NZF220DFT1G, SNZF220DFT1G

EMI Filter with ESD Protection

Features

- 2 EMI/RFI Bi-directional “Pi” Low-Pass Filters
- ESD Protection Meets IEC61000-4-2
- Diode Capacitance: 7 – 10 pF
- Zener/Resistor Line Capacitance: $22 \pm 20\%$ pF
- Low Zener Diode Leakage: 1 μ A Maximum
- Zener Breakdown Voltage; 6 – 8 V
- AEC-Q101 Qualified and PPAP Capable – SNZF220DFT1G
- S Prefix for Automotive and Other Applications Requiring Unique Site and Control Change Requirements
- These are Pb-Free Devices

Benefits

- Designed to suppress EMI/RFI Noise in Systems Subjected to Electromagnetic Interference
- Nominal Cutoff Frequency of 220 MHz (per Figure 2)
- Small Package Size Minimizes Parasitic Inductance, Thus a More “Ideal” Low Pass Filtering Response

Typical Applications

- Cellular Phones
- Communication Systems
- Computers
- Portable Products with Input/Output Conductors

MAXIMUM RATINGS

Rating	Symbol	Value	Unit
Peak Power Dissipation (Note 1) $8 \times 20 \mu$ s Pulse	P_{PK}	14	W
Maximum Junction Temperature	T_J	150	$^{\circ}$ C

Maximum ratings are those values beyond which device damage can occur. Maximum ratings applied to the device are individual stress limit values (not normal operating conditions) and are not valid simultaneously. If these limits are exceeded, device functional operation is not implied, damage may occur and reliability may be affected.

1. Between I/O Pins



ON Semiconductor®

<http://onsemi.com>

CIRCUIT DESCRIPTION

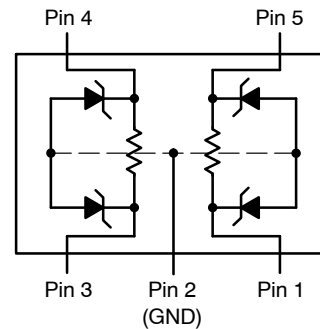

SC-88A
DF SUFFIX
CASE 419A

MARKING DIAGRAM

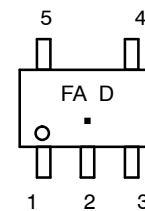

FA = Specific Device Code
D = Date Code
■ = Pb-Free Package

ORDERING INFORMATION

Device	Package	Shipping†
NZF220DFT1G	SC-88A (Pb-Free)	3000 / Tape & Reel
SNZF220DFT1G	SC-88A (Pb-Free)	3000 / Tape & Reel

†For information on tape and reel specifications, including part orientation and tape sizes, please refer to our Tape and Reel Packaging Specifications Brochure, BRD8011/D.

NZF220DFT1G, SNZF220DFT1G

ELECTRICAL CHARACTERISTICS

Symbol	Characteristic	Min	Typ	Max	Unit
V_Z	Zener Breakdown Voltage, @ $I_{ZT} = 1$ mA	6.0	–	8.0	V
I_r	Zener Leakage Current, @ $V_R = 3$ V	N/A	–	1.0	μ A
V_F	Zener Forward Voltage, @ $I_F = 50$ mA	N/A	–	1.5	V
Capacitance	Zener Internal Capacitance, @ 0 V Bias	7.0	–	10	pF
Capacitance	Zener/Resistor Array Line Capacitance	17.6	–	26.4	pF
Resistor	Resistance	90	–	110	Ω
F_C (Note 2)	Cutoff Frequency	–	220	–	MHz

2. 50 Ω Source and 50 Ω Lead Termination per Figure 2.

Applications Information

Suppressing Noise at the Source

- Filter all I/O signals leaving the noisy environment
- Locate I/O driver circuits close to the connector
- Use the longest rise/fall times possible for all digital signals

Reducing Noise at the Receiver

- Filter all I/O signals entering the unit
- Locate the I/O filters as close as possible to the connector

Minimizing Noise Coupling

- Use multilayer PCBs to minimize power and ground inductance
- Keep clock circuits away from the I/O connector
- Ground planes should be used whenever possible
- Minimize the loop area for all high speed signals
- Provide for adequate power decoupling

ESD Protection

- Locate the suppression devices as close to the I/O connector as possible
- Minimize the PCB trace length to the suppression device
- Minimize the PCB trace length for the ground return for the suppression device

NZF220DFT1G, SNZF220DFT1G

FREQUENCY RESPONSE SPECIFICATION

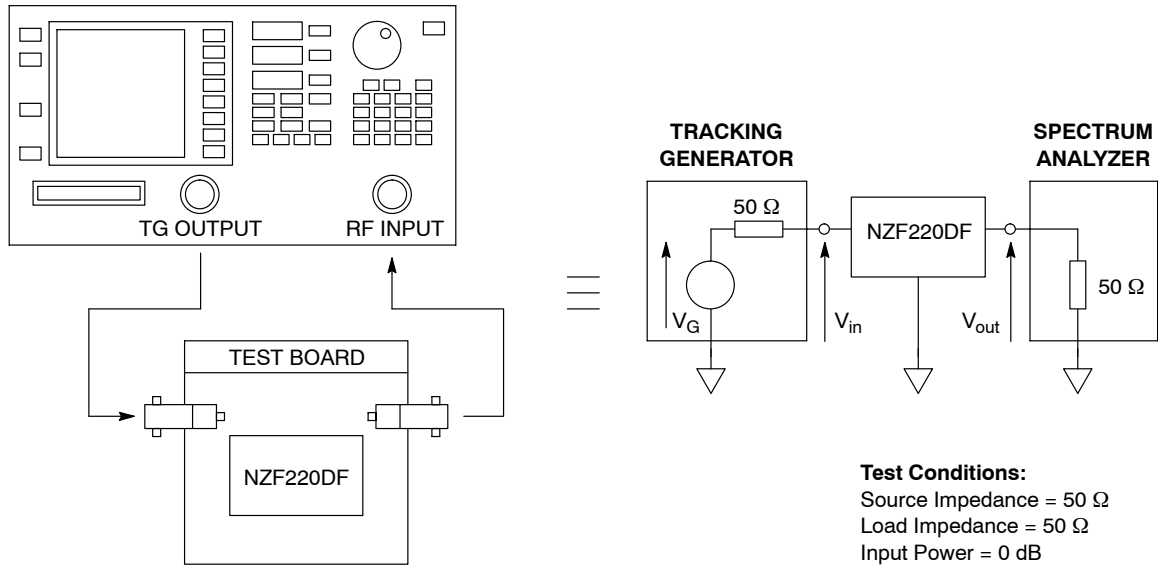

Figure 1. Measurement Conditions

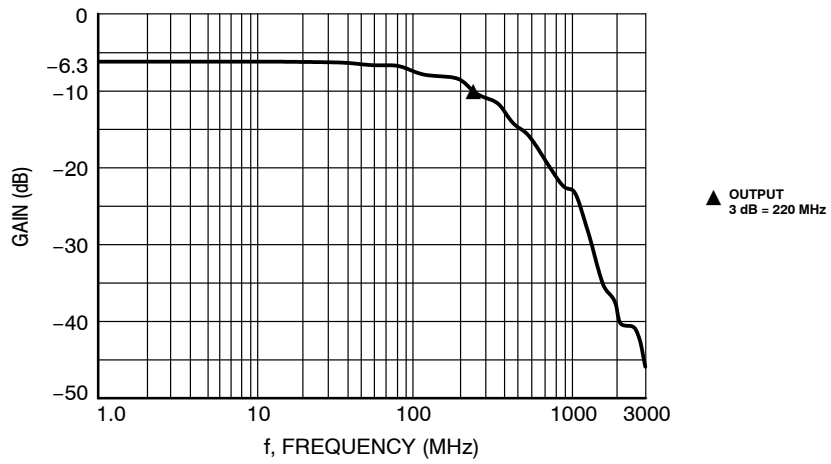

Figure 2. Typical EMI Filter Response
 (50 Ω Source and 50 Ω Lead Termination)

MECHANICAL CASE OUTLINE PACKAGE DIMENSIONS

ON Semiconductor®



SCALE 2:1

SC-88A (SC-70-5/SOT-353)
CASE 419A-02
ISSUE L

DATE 17 JAN 2013

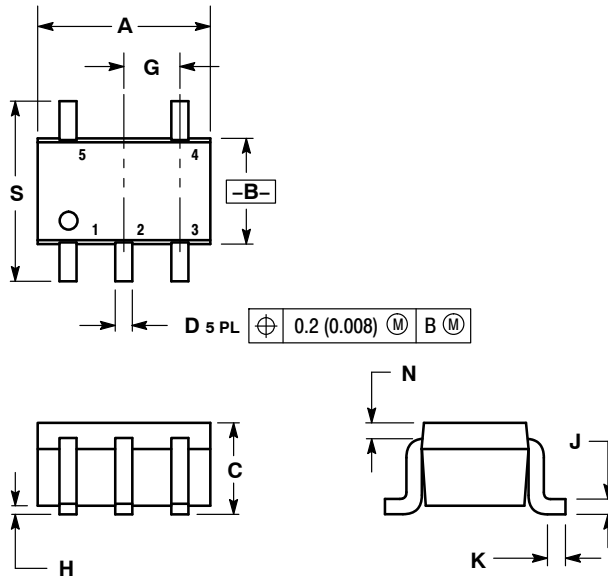

SOLDER FOOTPRINT

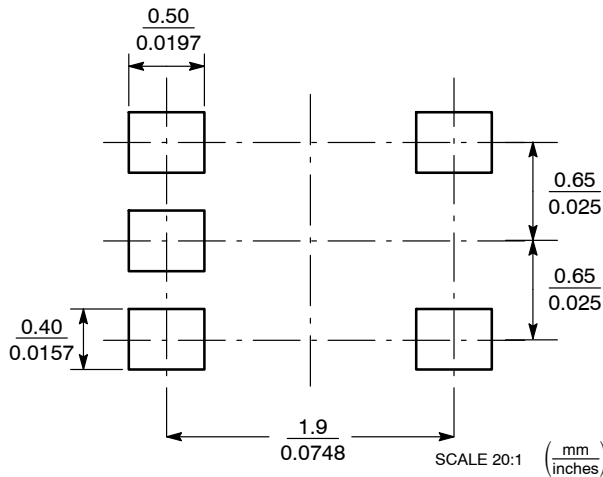

NOTES:

1. DIMENSIONING AND TOLERANCING PER ANSI Y14.5M, 1982.
2. CONTROLLING DIMENSION: INCH.
3. 419A-01 OBSOLETE. NEW STANDARD 419A-02.
4. DIMENSIONS A AND B DO NOT INCLUDE MOLD FLASH, PROTRUSIONS, OR GATE BURRS.

DIM	INCHES		MILLIMETERS	
	MIN	MAX	MIN	MAX
A	0.071	0.087	1.80	2.20
B	0.045	0.053	1.15	1.35
C	0.031	0.043	0.80	1.10
D	0.004	0.012	0.10	0.30
G	0.026 BSC		0.65 BSC	
H	---	0.004	---	0.10
J	0.004	0.010	0.10	0.25
K	0.004	0.012	0.10	0.30
N	0.008 REF		0.20 REF	
S	0.079	0.087	2.00	2.20

GENERIC MARKING DIAGRAM*

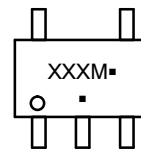

- XXX = Specific Device Code
- M = Date Code
- = Pb-Free Package

(Note: Microdot may be in either location)

*This information is generic. Please refer to device data sheet for actual part marking. Pb-Free indicator, "G" or microdot "■", may or may not be present. Some products may not follow the Generic Marking.

- | | | | | |
|--|--|--|--|--|
| <p>STYLE 1:
PIN 1. BASE
2. EMITTER
3. BASE
4. COLLECTOR
5. COLLECTOR</p> | <p>STYLE 2:
PIN 1. ANODE
2. EMITTER
3. BASE
4. COLLECTOR
5. CATHODE</p> | <p>STYLE 3:
PIN 1. ANODE 1
2. N/C
3. ANODE 2
4. CATHODE 2
5. CATHODE 1</p> | <p>STYLE 4:
PIN 1. SOURCE 1
2. DRAIN 1/2
3. SOURCE 1
4. GATE 1
5. GATE 2</p> | <p>STYLE 5:
PIN 1. CATHODE
2. COMMON ANODE
3. CATHODE 2
4. CATHODE 3
5. CATHODE 4</p> |
| <p>STYLE 6:
PIN 1. EMITTER 2
2. BASE 2
3. EMITTER 1
4. COLLECTOR
5. COLLECTOR 2/BASE 1</p> | <p>STYLE 7:
PIN 1. BASE
2. EMITTER
3. BASE
4. COLLECTOR
5. COLLECTOR</p> | <p>STYLE 8:
PIN 1. CATHODE
2. COLLECTOR
3. N/C
4. BASE
5. EMITTER</p> | <p>STYLE 9:
PIN 1. ANODE
2. CATHODE
3. ANODE
4. ANODE
5. ANODE</p> | <p>Note: Please refer to datasheet for style callout. If style type is not called out in the datasheet refer to the device datasheet pinout or pin assignment.</p> |

DOCUMENT NUMBER:	98ASB42984B	Electronic versions are uncontrolled except when accessed directly from the Document Repository. Printed versions are uncontrolled except when stamped "CONTROLLED COPY" in red.
DESCRIPTION:	SC-88A (SC-70-5/SOT-353)	PAGE 1 OF 1

ON Semiconductor and ON are trademarks of Semiconductor Components Industries, LLC dba ON Semiconductor or its subsidiaries in the United States and/or other countries. ON Semiconductor reserves the right to make changes without further notice to any products herein. ON Semiconductor makes no warranty, representation or guarantee regarding the suitability of its products for any particular purpose, nor does ON Semiconductor assume any liability arising out of the application or use of any product or circuit, and specifically disclaims any and all liability, including without limitation special, consequential or incidental damages. ON Semiconductor does not convey any license under its patent rights nor the rights of others.

onsemi, **Onsemi**, and other names, marks, and brands are registered and/or common law trademarks of Semiconductor Components Industries, LLC dba "**onsemi**" or its affiliates and/or subsidiaries in the United States and/or other countries. **onsemi** owns the rights to a number of patents, trademarks, copyrights, trade secrets, and other intellectual property. A listing of **onsemi**'s product/patent coverage may be accessed at www.onsemi.com/site/pdf/Patent-Marking.pdf. **onsemi** reserves the right to make changes at any time to any products or information herein, without notice. The information herein is provided "as-is" and **onsemi** makes no warranty, representation or guarantee regarding the accuracy of the information, product features, availability, functionality, or suitability of its products for any particular purpose, nor does **onsemi** assume any liability arising out of the application or use of any product or circuit, and specifically disclaims any and all liability, including without limitation special, consequential or incidental damages. Buyer is responsible for its products and applications using **onsemi** products, including compliance with all laws, regulations and safety requirements or standards, regardless of any support or applications information provided by **onsemi**. "Typical" parameters which may be provided in **onsemi** data sheets and/or specifications can and do vary in different applications and actual performance may vary over time. All operating parameters, including "Typicals" must be validated for each customer application by customer's technical experts. **onsemi** does not convey any license under any of its intellectual property rights nor the rights of others. **onsemi** products are not designed, intended, or authorized for use as a critical component in life support systems or any FDA Class 3 medical devices or medical devices with a same or similar classification in a foreign jurisdiction or any devices intended for implantation in the human body. Should Buyer purchase or use **onsemi** products for any such unintended or unauthorized application, Buyer shall indemnify and hold **onsemi** and its officers, employees, subsidiaries, affiliates, and distributors harmless against all claims, costs, damages, and expenses, and reasonable attorney fees arising out of, directly or indirectly, any claim of personal injury or death associated with such unintended or unauthorized use, even if such claim alleges that **onsemi** was negligent regarding the design or manufacture of the part. **onsemi** is an Equal Opportunity/Affirmative Action Employer. This literature is subject to all applicable copyright laws and is not for resale in any manner.

PUBLICATION ORDERING INFORMATION

LITERATURE FULFILLMENT:

Email Requests to: orderlit@onsemi.com

onsemi Website: www.onsemi.com

TECHNICAL SUPPORT

North American Technical Support:

Voice Mail: 1 800-282-9855 Toll Free USA/Canada

Phone: 011 421 33 790 2910

Europe, Middle East and Africa Technical Support:

Phone: 00421 33 790 2910

For additional information, please contact your local Sales Representative

