

MMBD352LT1, MMBD353LT1, MMBD354LT1, MMBD355LT1

Dual Hot Carrier Mixer Diodes

These devices are designed primarily for UHF mixer applications but are suitable also for use in detector and ultra-fast switching circuits.

Features

- Very Low Capacitance – Less Than 1.0 pF @ Zero V
- Low Forward Voltage – 0.5 V (Typ) @ $I_F = 10$ mA
- Pb-Free Packages are Available

MAXIMUM RATINGS (EACH DIODE)

Rating	Symbol	Value	Unit
Continuous Reverse Voltage	V_R	7.0	V_{CC}

THERMAL CHARACTERISTICS

Characteristic	Symbol	Max	Unit
Total Device Dissipation FR-5 Board, (Note 1) $T_A = 25^\circ\text{C}$ Derate above 25°C	P_D	225 1.8	mW mW/ $^\circ\text{C}$
Thermal Resistance, Junction-to-Ambient	$R_{\theta JA}$	556	$^\circ\text{C}/\text{W}$
Total Device Dissipation Alumina Substrate, (Note 2) $T_A = 25^\circ\text{C}$ Derate above 25°C	P_D	300 2.4	mW mW/ $^\circ\text{C}$
Thermal Resistance, Junction-to-Ambient	$R_{\theta JA}$	417	$^\circ\text{C}/\text{W}$
Junction and Storage Temperature	T_J, T_{stg}	-55 to +150	$^\circ\text{C}$

Maximum ratings are those values beyond which device damage can occur. Maximum ratings applied to the device are individual stress limit values (not normal operating conditions) and are not valid simultaneously. If these limits are exceeded, device functional operation is not implied, damage may occur and reliability may be affected.

1. FR-5 = 1.0 x 0.75 x 0.062 in.
2. Alumina = 0.4 x 0.3 x 0.024 in. 99.5% alumina.

ELECTRICAL CHARACTERISTICS ($T_A = 25^\circ\text{C}$ unless otherwise noted) (EACH DIODE)

Rating	Symbol	Min	Max	Unit
Forward Voltage ($I_F = 10$ mAdc)	V_F	-	0.60	V
Reverse Leakage Current (Note 3) ($V_R = 3.0$ V) ($V_R = 7.0$ V)	I_R	-	0.25 10	μA
Capacitance ($V_R = 0$ V, $f = 1.0$ MHz)	C	-	1.0	pF

3. For each individual diode while the second diode is unbiased.



ON Semiconductor®

<http://onsemi.com>

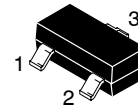

SOT-23 (TO-236)
CASE 318

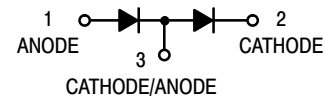

MMBD352LT1
STYLE 11

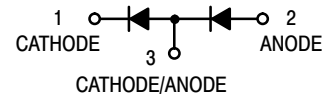

MMBD353LT1
STYLE 19

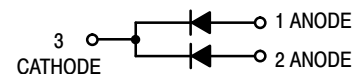

MMBD354LT1
STYLE 9

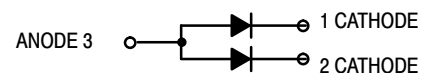

MMBD355LT1
STYLE 12

MARKING DIAGRAM

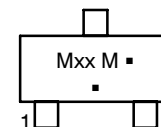

Mxx = Device Code
M = Date Code*
▪ = Pb-Free Package

(Note: Microdot may be in either location)
*Date Code orientation and/or overbar may vary depending upon manufacturing location.

ORDERING INFORMATION

See detailed ordering, marking, and shipping information in the package dimensions section on page 2 of this data sheet.

MMBD352LT1, MMBD353LT1, MMBD354LT1, MMBD355LT1

TYPICAL CHARACTERISTICS

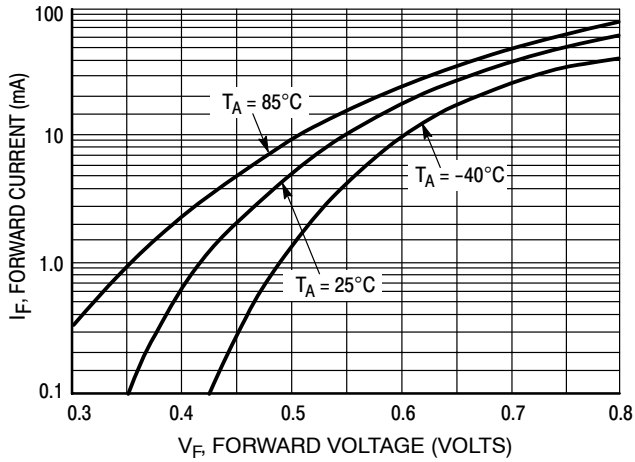

Figure 1. Forward Voltage

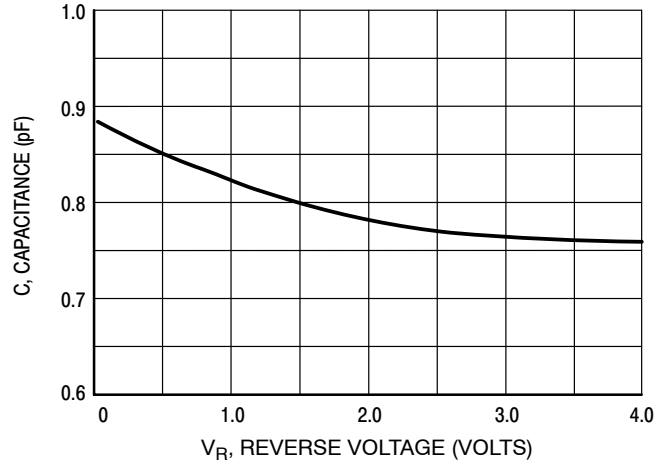

Figure 2. Capacitance

ORDERING INFORMATION

Device	Marking	Package	Shipping [†]
MMBD352LT1	M5G	SOT-23	3,000 Units / Tape & Reel
MMBD352LT1G		SOT-23 (Pb-Free)	3,000 Units / Tape & Reel
MMBD352LT3		SOT-23	10,000 Units / Tape & Reel
MMBD352LT3G		SOT-23 (Pb-Free)	10,000 Units / Tape & Reel
MMBD353LT1	M4F	SOT-23	3,000 Units / Tape & Reel
MMBD353LT1G		SOT-23 (Pb-Free)	3,000 Units / Tape & Reel
MMBD353LT3		SOT-23	10,000 Units / Tape & Reel
MMBD353LT3G		SOT-23 (Pb-Free)	10,000 Units / Tape & Reel
MMBD354LT1	M6H	SOT-23	3,000 Units / Tape & Reel
MMBD354LT1G		SOT-23 (Pb-Free)	3,000 Units / Tape & Reel
MMBD355LT1	MJ1	SOT-23	3,000 Units / Tape & Reel
MMBD355LT1G		SOT-23 (Pb-Free)	3,000 Units / Tape & Reel

[†]For information on tape and reel specifications, including part orientation and tape sizes, please refer to our Tape and Reel Packaging Specifications Brochure, BRD8011/D.

MMBD352LT1, MMBD353LT1, MMBD354LT1, MMBD355LT1

PACKAGE DIMENSIONS

SOT-23 (TO-236) CASE 318-08 ISSUE AN

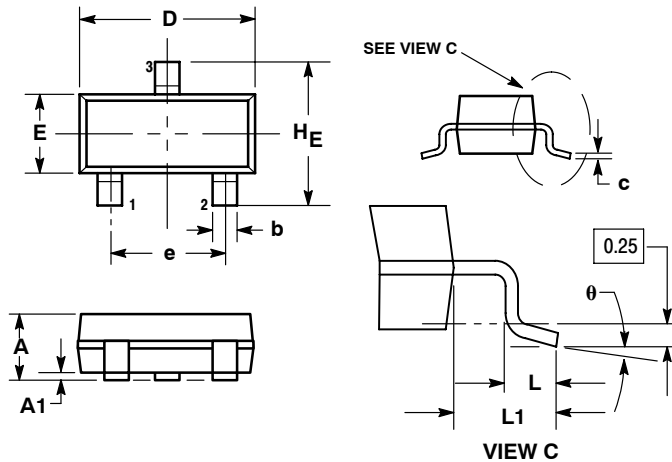

NOTES:

1. DIMENSIONING AND TOLERANCING PER ANSI Y14.5M, 1982.
2. CONTROLLING DIMENSION: INCH.
3. MAXIMUM LEAD THICKNESS INCLUDES LEAD FINISH THICKNESS. MINIMUM LEAD THICKNESS IS THE MINIMUM THICKNESS OF BASE MATERIAL.
4. 318-01 THRU -07 AND -09 OBSOLETE, NEW STANDARD 318-08.

DIM	MILLIMETERS			INCHES		
	MIN	NOM	MAX	MIN	NOM	MAX
A	0.89	1.00	1.11	0.035	0.040	0.044
A1	0.01	0.06	0.10	0.001	0.002	0.004
b	0.37	0.44	0.50	0.015	0.018	0.020
c	0.09	0.13	0.18	0.003	0.005	0.007
D	2.80	2.90	3.04	0.110	0.114	0.120
E	1.20	1.30	1.40	0.047	0.051	0.055
e	1.78	1.90	2.04	0.070	0.075	0.081
L	0.10	0.20	0.30	0.004	0.008	0.012
L1	0.35	0.54	0.69	0.014	0.021	0.029
HE	2.10	2.40	2.64	0.083	0.094	0.104

MMBD352LT1

STYLE 11:

1. ANODE
2. CATHODE
3. CATHODE-ANODE

MMBD353LT1

STYLE 19:

1. CATHODE
2. ANODE
3. CATHODE-ANODE

MMBD354LT1

STYLE 9:

1. ANODE
2. ANODE
3. CATHODE

MMBD355LT1

STYLE 12:

1. CATHODE
2. CATHODE
3. ANODE

SOLDERING FOOTPRINT*

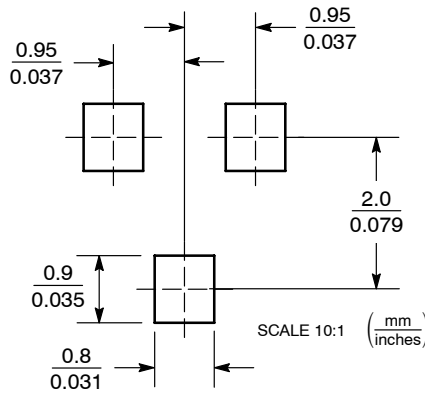

*For additional information on our Pb-Free strategy and soldering details, please download the ON Semiconductor Soldering and Mounting Techniques Reference Manual, SOLDERRM/D.

ON Semiconductor and are registered trademarks of Semiconductor Components Industries, LLC (SCILLC). SCILLC reserves the right to make changes without further notice to any products herein. SCILLC makes no warranty, representation or guarantee regarding the suitability of its products for any particular purpose, nor does SCILLC assume any liability arising out of the application or use of any product or circuit, and specifically disclaims any and all liability, including without limitation special, consequential or incidental damages. "Typical" parameters which may be provided in SCILLC data sheets and/or specifications can and do vary in different applications and actual performance may vary over time. All operating parameters, including "Typicals" must be validated for each customer application by customer's technical experts. SCILLC does not convey any license under its patent rights nor the rights of others. SCILLC products are not designed, intended, or authorized for use as components in systems intended for surgical implant into the body, or other applications intended to support or sustain life, or for any other application in which the failure of the SCILLC product could create a situation where personal injury or death may occur. Should Buyer purchase or use SCILLC products for any such unintended or unauthorized application, Buyer shall indemnify and hold SCILLC and its officers, employees, subsidiaries, affiliates, and distributors harmless against all claims, costs, damages, and expenses, and reasonable attorney fees arising out of, directly or indirectly, any claim of personal injury or death associated with such unintended or unauthorized use, even if such claim alleges that SCILLC was negligent regarding the design or manufacture of the part. SCILLC is an Equal Opportunity/Affirmative Action Employer. This literature is subject to all applicable copyright laws and is not for resale in any manner.

PUBLICATION ORDERING INFORMATION

LITERATURE FULFILLMENT:

Literature Distribution Center for ON Semiconductor
P.O. Box 5163, Denver, Colorado 80217 USA
Phone: 303-675-2175 or 800-344-3860 Toll Free USA/Canada
Fax: 303-675-2176 or 800-344-3867 Toll Free USA/Canada
Email: orderlit@onsemi.com

N. American Technical Support: 800-282-9855 Toll Free
USA/Canada
Europe, Middle East and Africa Technical Support:
Phone: 421 33 790 2910
Japan Customer Focus Center
Phone: 81-3-5773-3850

ON Semiconductor Website: www.onsemi.com

Order Literature: <http://www.onsemi.com/orderlit>

For additional information, please contact your local Sales Representative

MMBD352LT1/D