

74AHC574; 74AHCT574

Octal D-type flip-flop; positive edge-trigger; 3-state

Rev. 02 — 24 January 2008

Product data sheet

1. General description

The 74AHC574; 74AHCT574 are high-speed Si-gate CMOS devices and are pin compatible with Low Power Schottky TTL (LSTTL). They are specified in compliance with JEDEC standard no. 7A.

The 74AHC574; 74AHCT574 are octal D-type flip-flops featuring separate D-type inputs for each flip-flop and 3-state outputs for bus oriented applications. A clock (CP) and an output enable (\overline{OE}) input are common to all flip-flops.

The 8 flip-flops will store the state of their individual D-inputs that meet the set-up and hold times requirements on the LOW-to-HIGH CP transition.

When \overline{OE} is LOW the contents of the 8 flip-flops are available at the outputs. When \overline{OE} is HIGH, the outputs go to the high-impedance OFF-state. Operation of the \overline{OE} input does not affect the state of the flip-flops.

The 74AHC574; 74AHCT574 is functionally identical to the 74AHC564; 74AHCT564, but has non-inverting outputs. The 74AHC574; 74AHCT574 is functionally identical to the 74AHC374; 74AHCT374, but has a different pinning.

2. Features

- Balanced propagation delays
- All inputs have a Schmitt-trigger action
- 3-state non-inverting outputs for bus orientated applications
- 8-bit positive, edge-triggered register
- Independent register and 3-state buffer operation
- Common 3-state output enable input
- For 74AHC574 only: operates with CMOS input levels
- For 74AHCT574 only: operates with TTL input levels
- ESD protection:
 - ◆ HBM JESD22-A114E exceeds 2000 V
 - ◆ MM JESD22-A115-A exceeds 200 V
 - ◆ CDM JESD22-C101C exceeds 1000 V
- Multiple package options
- Specified from $-40\text{ }^{\circ}\text{C}$ to $+85\text{ }^{\circ}\text{C}$ and from $-40\text{ }^{\circ}\text{C}$ to $+125\text{ }^{\circ}\text{C}$

nexperia

3. Ordering information

Table 1. Ordering information

Type number	Package			Version
	Temperature range	Name	Description	
74AHC574D 74AHCT574D	-40 °C to +125 °C	SO20	plastic small outline package; 20 leads; body width 7.5 mm	SOT163-1
74AHC574PW 74AHCT574PW	-40 °C to +125 °C	TSSOP20	plastic thin shrink small outline package; 20 leads; body width 4.4 mm	SOT360-1
74AHC574BQ 74AHCT574BQ	-40 °C to +125 °C	DHVQFN20	plastic dual in-line compatible thermal enhanced very thin quad flat package; no leads; 20 terminals; body 2.5 × 4.5 × 0.85 mm	SOT764-1

4. Functional diagram

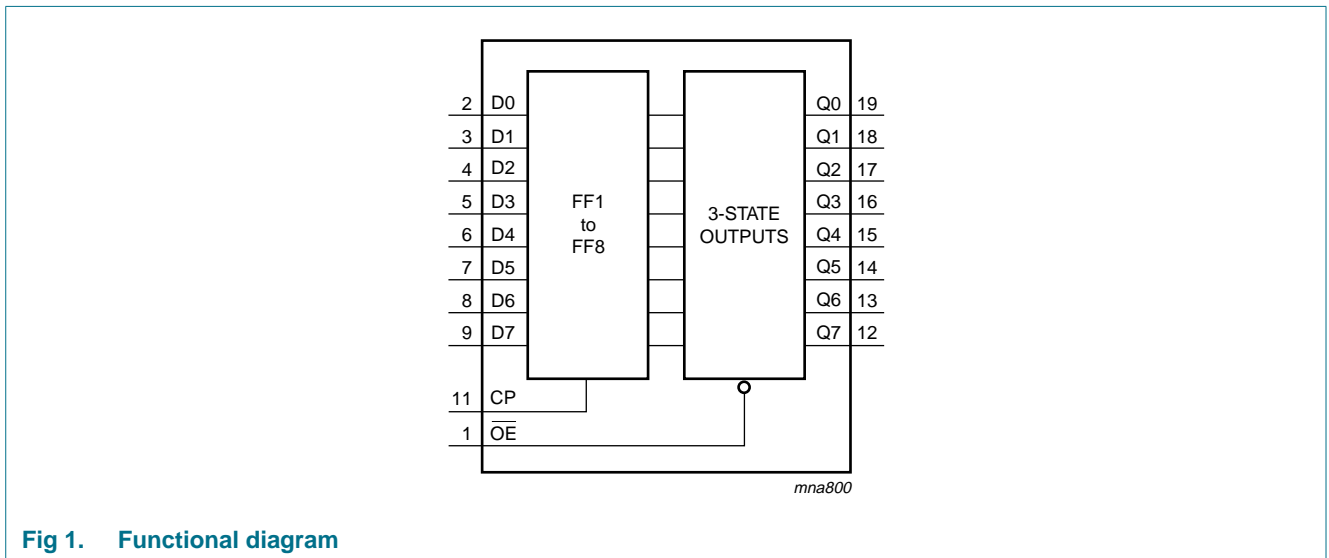

Fig 1. Functional diagram

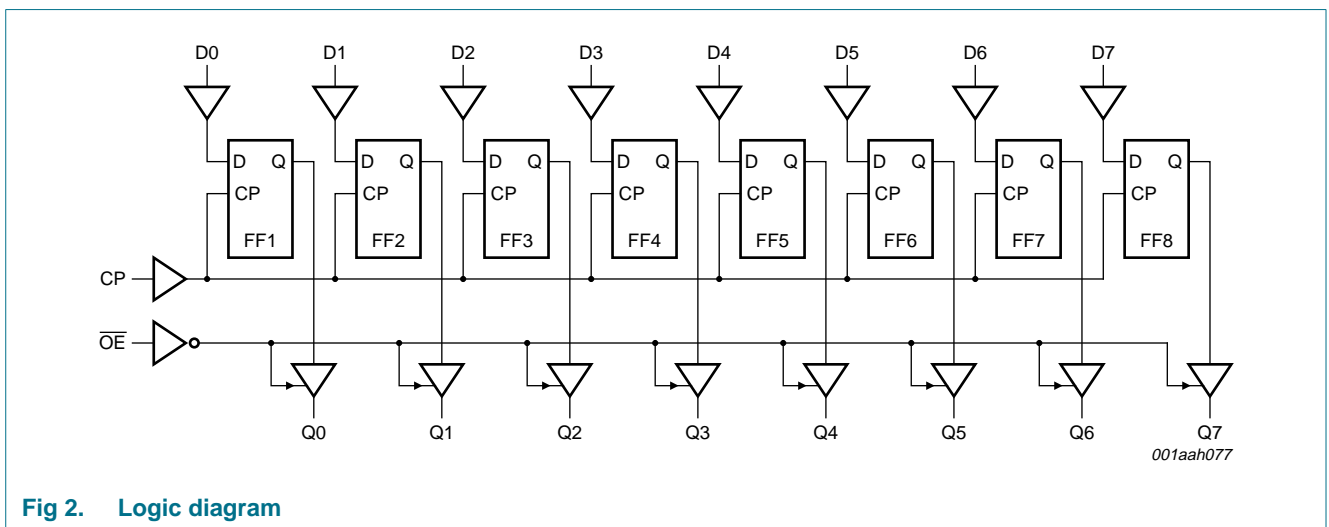

Fig 2. Logic diagram

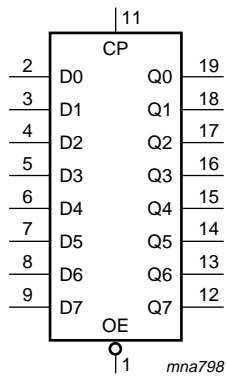

Fig 3. Logic symbol

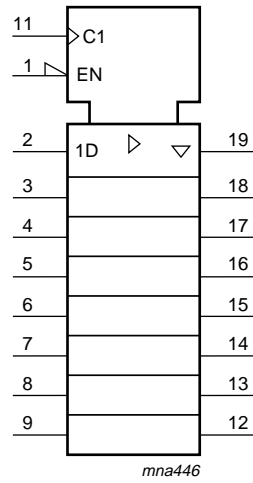
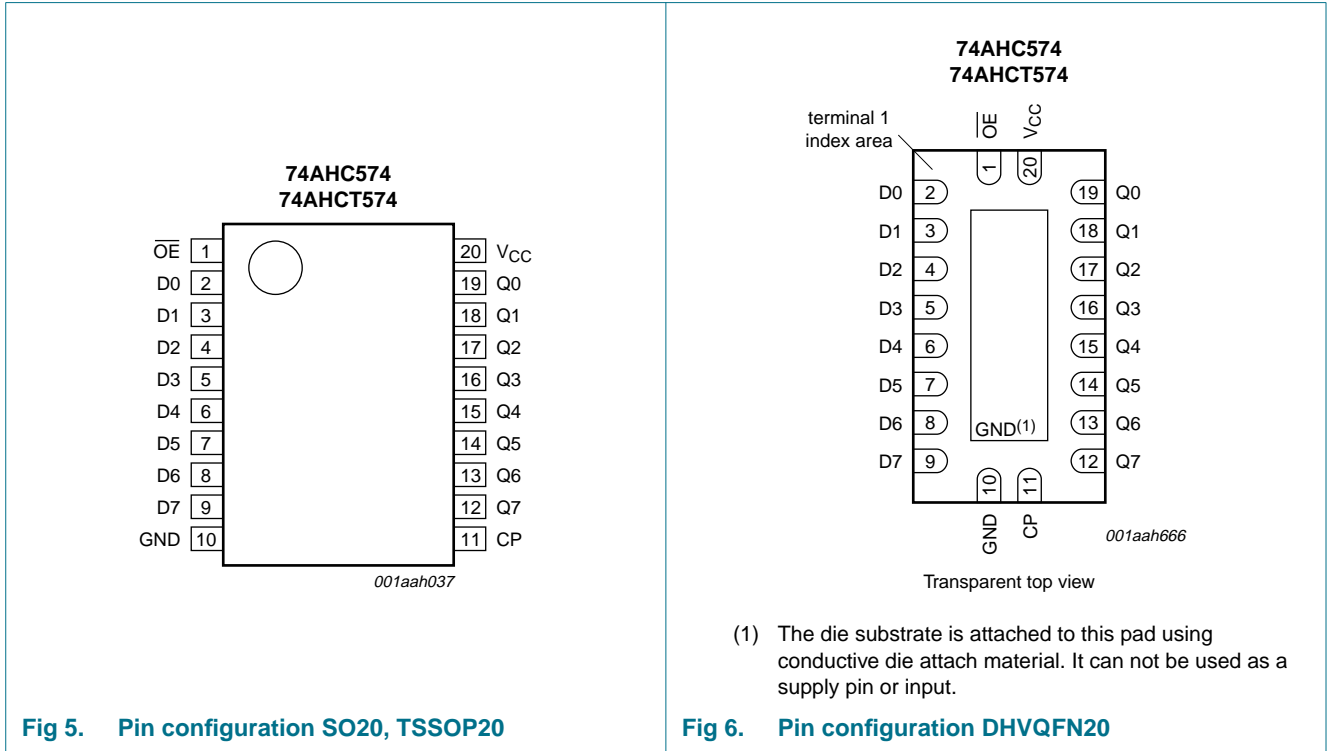

Fig 4. IEC logic symbol

5. Pinning information

5.1 Pinning



5.2 Pin description

Table 2. Pin description

Symbol	Pin	Description
\overline{OE}	1	3-state output enable input (active LOW)
D[0:7]	2, 3, 4, 5, 6, 7, 8, 9	data input
GND	10	ground (0 V)
CP	11	clock input (LOW-to-HIGH, edge triggered)
Q[0:7]	19, 18, 17, 16, 15, 14, 13, 12	3-state flip-flop output
V_{CC}	20	supply voltage

6. Functional description

Table 3. Function table^[1]

Operating mode	Input			Internal flip-flop	Output Qn
	\overline{OE}	CP	Dn		
Load and read register	L	↑	l	L	L
	L	↑	h	H	H
Load register and disable output	H	↑	l	L	Z
	H	↑	h	H	Z

- [1] H = HIGH voltage level;
 h = HIGH voltage level one setup time prior to the HIGH-to-LOW CP transition;
 L = LOW voltage level;
 l = LOW voltage level one setup time prior to the HIGH-to-LOW CP transition;
 Z = high-impedance OFF-state;
 ↑ = LOW-to-HIGH clock transition.

7. Limiting values

Table 4. Limiting values

In accordance with the Absolute Maximum Rating System (IEC 60134). Voltages are referenced to GND (ground = 0 V).

Symbol	Parameter	Conditions	Min	Max	Unit
V_{CC}	supply voltage		-0.5	+7.0	V
V_I	input voltage		-0.5	+7.0	V
I_{IK}	input clamping current	$V_I < -0.5$ V	[1] -20	-	mA
I_{OK}	output clamping current	$V_O < -0.5$ V or $V_O > V_{CC} + 0.5$ V	[1] -	±20	mA
I_O	output current	$V_O = -0.5$ V to $(V_{CC} + 0.5$ V)	-	±25	mA
I_{CC}	supply current		-	75	mA
I_{GND}	ground current		-75	-	mA
T_{stg}	storage temperature		-65	+150	°C
P_{tot}	total power dissipation	$T_{amb} = -40$ °C to +125 °C			
	SO20 package		[2] -	500	mW
	TSSOP20 package		[3] -	500	mW
	DHVQFN20 package		[4] -	500	mW

- [1] The input and output voltage ratings may be exceeded if the input and output current ratings are observed.
 [2] P_{tot} derates linearly with 8 mW/K above 70 °C.
 [3] P_{tot} derates linearly with 5.5 mW/K above 60 °C.
 [4] P_{tot} derates linearly with 4.5 mW/K above 60 °C.

8. Recommended operating conditions

Table 5. Recommended operating conditions

Voltages are referenced to GND (ground = 0 V).

Symbol	Parameter	Conditions	74AHC574			74AHCT574			Unit
			Min	Typ	Max	Min	Typ	Max	
V _{CC}	supply voltage		2.0	5.0	5.5	4.5	5.0	5.5	V
V _I	input voltage		0	-	5.5	0	-	5.5	V
V _O	output voltage		0	-	V _{CC}	0	-	V _{CC}	V
T _{amb}	ambient temperature		-40	+25	+125	-40	+25	+125	°C
Δt/ΔV	input transition rise and fall rate	V _{CC} = 3.3 V ± 0.3 V	-	-	100	-	-	-	ns/V
		V _{CC} = 5.0 V ± 0.5 V	-	-	20	-	-	20	ns/V

9. Static characteristics

Table 6. Static characteristics

Voltages are referenced to GND (ground = 0 V).

Symbol	Parameter	Conditions	25 °C			-40 °C to +85 °C		-40 °C to +125 °C		Unit
			Min	Typ	Max	Min	Max	Min	Max	
For type 74AHC574										
V _{IH}	HIGH-level input voltage	V _{CC} = 2.0 V	1.5	-	-	1.5	-	1.5	-	V
		V _{CC} = 3.0 V	2.1	-	-	2.1	-	2.1	-	V
		V _{CC} = 5.5 V	3.85	-	-	3.85	-	3.85	-	V
V _{IL}	LOW-level input voltage	V _{CC} = 2.0 V	-	-	0.5	-	0.5	-	0.5	V
		V _{CC} = 3.0 V	-	-	0.9	-	0.9	-	0.9	V
		V _{CC} = 5.5 V	-	-	1.65	-	1.65	-	1.65	V
V _{OH}	HIGH-level output voltage	V _I = V _{IH} or V _{IL}								
		I _O = -50 μA; V _{CC} = 2.0 V	1.9	2.0	-	1.9	-	1.9	-	V
		I _O = -50 μA; V _{CC} = 3.0 V	2.9	3.0	-	2.9	-	2.9	-	V
		I _O = -50 μA; V _{CC} = 4.5 V	4.4	4.5	-	4.4	-	4.4	-	V
		I _O = -4.0 mA; V _{CC} = 3.0 V	2.58	-	-	2.48	-	2.40	-	V
		I _O = -8.0 mA; V _{CC} = 4.5 V	3.94	-	-	3.8	-	3.70	-	V
V _{OL}	LOW-level output voltage	V _I = V _{IH} or V _{IL}								
		I _O = 50 μA; V _{CC} = 2.0 V	-	0	0.1	-	0.1	-	0.1	V
		I _O = 50 μA; V _{CC} = 3.0 V	-	0	0.1	-	0.1	-	0.1	V
		I _O = 50 μA; V _{CC} = 4.5 V	-	0	0.1	-	0.1	-	0.1	V
		I _O = 4.0 mA; V _{CC} = 3.0 V	-	-	0.36	-	0.44	-	0.55	V
		I _O = 8.0 mA; V _{CC} = 4.5 V	-	-	0.36	-	0.44	-	0.55	V
I _{OZ}	OFF-state output current	V _I = V _{IH} or V _{IL} ; V _O = V _{CC} or GND; V _{CC} = 5.5 V	-	-	±0.25	-	±2.5	-	±10.0	μA
I _I	input leakage current	V _I = 5.5 V or GND; V _{CC} = 0 V to 5.5 V	-	-	0.1	-	1.0	-	2.0	μA
I _{CC}	supply current	V _I = V _{CC} or GND; I _O = 0 A; V _{CC} = 5.5 V	-	-	4.0	-	40	-	80	μA

Table 6. Static characteristics ...continued
 Voltages are referenced to GND (ground = 0 V).

Symbol	Parameter	Conditions	25 °C			−40 °C to +85 °C		−40 °C to +125 °C		Unit
			Min	Typ	Max	Min	Max	Min	Max	
C _I	input capacitance		-	3.0	10	-	10	-	10	pF
C _O	output capacitance		-	4.0	-	-	-	-	-	pF
For type 74AHCT574										
V _{IH}	HIGH-level input voltage	V _{CC} = 4.5 V to 5.5 V	2.0	-	-	2.0	-	2.0	-	V
V _{IL}	LOW-level input voltage	V _{CC} = 4.5 V to 5.5 V	-	-	0.8	-	0.8	-	0.8	V
V _{OH}	HIGH-level output voltage	V _I = V _{IH} or V _{IL} ; V _{CC} = 4.5 V								
		I _O = −50 μA	4.4	4.5	-	4.4	-	4.4	-	V
		I _O = −8.0 mA	3.94	-	-	3.8	-	3.70	-	V
V _{OL}	LOW-level output voltage	V _I = V _{IH} or V _{IL} ; V _{CC} = 4.5 V								
		I _O = 50 μA	-	0	0.1	-	0.1	-	0.1	V
		I _O = 8.0 mA	-	-	0.36	-	0.44	-	0.55	V
I _{OZ}	OFF-state output current	per input pin; V _I = V _{IH} or V _{IL} ; V _{CC} = 5.5 V; I _O = 0 A; V _O = V _{CC} or GND; other pins at V _{CC} or GND	-	-	±0.25	-	±2.5	-	±10.0	μA
I _I	input leakage current	V _I = 5.5 V or GND; V _{CC} = 0 V to 5.5 V	-	-	0.1	-	1.0	-	2.0	μA
I _{CC}	supply current	V _I = V _{CC} or GND; I _O = 0 A; V _{CC} = 5.5 V	-	-	4.0	-	40	-	80	μA
ΔI _{CC}	additional supply current	per input pin; V _I = V _{CC} − 2.1 V; I _O = 0 A; other pins at V _{CC} or GND; V _{CC} = 4.5 V to 5.5 V	-	-	1.35	-	1.5	-	1.5	mA
C _I	input capacitance		-	3	10	-	10	-	10	pF
C _O	output capacitance		-	4.0	-	-	-	-	-	pF

10. Dynamic characteristics

Table 7. Dynamic characteristics
GND = 0 V. For test circuit see Figure 10.

Symbol	Parameter	Conditions	25 °C			−40 °C to +85 °C		−40 °C to +125 °C		Unit
			Min	Typ ^[1]	Max	Min	Max	Min	Max	
For type 74AHC574										
t_{pd}	propagation delay	CP to Qn; see Figure 7 ^[2]								
		$V_{CC} = 3.0\text{ V to }3.6\text{ V}$								
		$C_L = 15\text{ pF}$	-	6.5	13.2	1.0	15.5	1.0	16.5	ns
		$C_L = 50\text{ pF}$	-	9.3	16.7	1.0	19.0	1.0	21.0	ns
		$V_{CC} = 4.5\text{ V to }5.5\text{ V}$								
		$C_L = 15\text{ pF}$	-	4.4	8.6	1.0	10.0	1.0	11.0	ns
t_{en}	enable time	\overline{OE} to Qn; see Figure 9 ^[1]								
		$V_{CC} = 3.0\text{ V to }3.6\text{ V}$								
		$C_L = 15\text{ pF}$	-	5.7	12.8	1.0	15.0	1.0	16.0	ns
		$C_L = 50\text{ pF}$	-	8.2	16.3	1.0	18.5	1.0	20.5	ns
		$V_{CC} = 4.5\text{ V to }5.5\text{ V}$								
		$C_L = 15\text{ pF}$	-	4.2	9.0	1.0	10.5	1.0	11.5	ns
t_{dis}	disable time	\overline{OE} to Qn; see Figure 9 ^[2]								
		$V_{CC} = 3.0\text{ V to }3.6\text{ V}$								
		$C_L = 15\text{ pF}$	-	6.3	13.0	1.0	15.0	1.0	16.5	ns
		$C_L = 50\text{ pF}$	-	9.1	15.0	1.0	17.0	1.0	19.0	ns
		$V_{CC} = 4.5\text{ V to }5.5\text{ V}$								
		$C_L = 15\text{ pF}$	-	4.3	9.0	1.0	10.5	1.0	11.5	ns
f_{max}	maximum frequency	CP; see Figure 7								
		$V_{CC} = 3.0\text{ V to }3.6\text{ V}$								
		$C_L = 15\text{ pF}$	80	125	-	65	-	65	-	MHz
		$C_L = 50\text{ pF}$	50	75	-	45	-	45	-	MHz
		$V_{CC} = 4.5\text{ V to }5.5\text{ V}$								
		$C_L = 15\text{ pF}$	130	180	-	110	-	110	-	MHz
t_W	pulse width	CP; HIGH or LOW; see Figure 7								
		$V_{CC} = 3.0\text{ V to }3.6\text{ V}; C_L = 50\text{ pF}$	5.0	-	-	5.0	-	5.0	-	ns
		$V_{CC} = 4.5\text{ V to }5.5\text{ V}; C_L = 50\text{ pF}$	5.0	-	-	5.0	-	5.0	-	ns

Table 7. Dynamic characteristics ...continued
GND = 0 V. For test circuit see Figure 10.

Symbol	Parameter	Conditions	25 °C			−40 °C to +85 °C		−40 °C to +125 °C		Unit
			Min	Typ ^[1]	Max	Min	Max	Min	Max	
t _{su}	set-up time	Dn to CP; see Figure 8								
		V _{CC} = 3.0 V to 3.6 V; C _L = 50 pF	3.5	-	-	3.5	-	3.5	-	ns
		V _{CC} = 4.5 V to 5.5 V; C _L = 50 pF	3.0	-	-	3.0	-	3.0	-	ns
t _h	hold time	Dn to CP; see Figure 8								
		V _{CC} = 3.0 V to 3.6 V; C _L = 50 pF	1.5	-	-	1.5	-	1.5	-	ns
		V _{CC} = 4.5 V to 5.5 V; C _L = 50 pF	1.5	-	-	1.5	-	1.5	-	ns
C _{PD}	power dissipation capacitance	C _L = 50 pF; f _i = 1 MHz; V _I = GND to V _{CC}	^[3]	-	10	-	-	-	-	pF
For type 74AHCT574										
t _{pd}	propagation delay	CP to Qn; see Figure 7		^[2]						
		V _{CC} = 4.5 V to 5.5 V								
		C _L = 15 pF	-	4.4	8.6	1.0	10.0	1.0	11.0	ns
		C _L = 50 pF	-	6.3	10.6	1.0	12.0	1.0	13.5	ns
t _{en}	enable time	$\overline{\text{OE}}$ to Qn; see Figure 9								
		V _{CC} = 4.5 V to 5.5 V								
		C _L = 15 pF	-	4.3	9.0	1.0	10.5	1.0	11.5	ns
		C _L = 50 pF	-	6.1	11.0	1.0	12.5	1.0	14.0	ns
t _{dis}	disable time	$\overline{\text{OE}}$ to Qn; see Figure 9		^[2]						
		V _{CC} = 4.5 V to 5.5 V								
		C _L = 15 pF	-	4.3	9.0	1.0	10.5	1.0	11.5	ns
		C _L = 50 pF	-	6.2	10.1	1.0	11.5	1.0	13.0	ns
f _{max}	maximum frequency	CP; see Figure 7								
		V _{CC} = 4.5 V to 5.5 V								
		C _L = 15 pF	130	180	-	110	-	110	-	MHz
		C _L = 50 pF	85	115	-	75	-	75	-	MHz
t _w	pulse width	CP; HIGH or LOW; see Figure 7								
		V _{CC} = 4.5 V to 5.5 V; C _L = 50 pF	5.0	-	-	5.5	-	5.5	-	ns
t _{su}	set-up time	Dn to CP; see Figure 8								
		V _{CC} = 4.5 V to 5.5 V; C _L = 50 pF	3.0	-	-	3.5	-	3.5	-	ns

Table 7. Dynamic characteristics ...continued
GND = 0 V. For test circuit see Figure 10.

Symbol	Parameter	Conditions	25 °C			-40 °C to +85 °C		-40 °C to +125 °C		Unit
			Min	Typ ^[1]	Max	Min	Max	Min	Max	
t_h	hold time	Dn to CP; see Figure 8 $V_{CC} = 4.5 \text{ V to } 5.5 \text{ V};$ $C_L = 50 \text{ pF}$	1.5	-	-	1.5	-	1.5	-	ns
C_{PD}	power dissipation capacitance	per buffer; $C_L = 50 \text{ pF}; f = 1 \text{ MHz};$ $V_I = \text{GND to } V_{CC}$	[3]	-	12	-	-	-	-	pF

- [1] Typical values are measured at nominal supply voltage ($V_{CC} = 3.3 \text{ V}$ and $V_{CC} = 5.0 \text{ V}$).
- [2] t_{pd} is the same as t_{PLH} and t_{PHL} .
 t_{en} is the same as t_{PZL} and t_{PZH} .
 t_{dis} is the same as t_{PLZ} and t_{PHZ} .
- [3] C_{PD} is used to determine the dynamic power dissipation P_D (μW).
 $P_D = C_{PD} \times V_{CC}^2 \times f_i + \sum (C_L \times V_{CC}^2 \times f_o)$ where:
 f_i = input frequency in MHz;
 f_o = output frequency in MHz;
 C_L = output load capacitance in pF;
 V_{CC} = supply voltage in V.

10.1 Waveforms



Measurement points are given in Table 8.
 V_{OL} and V_{OH} are typical voltage output levels that occur with the output load.

Fig 7. Propagation delay input (CP) to output (Qn), clock input (CP) pulse width and the maximum frequency (CP)



Measurement points are given in [Table 8](#).
 V_{OL} and V_{OH} are typical voltage output levels that occur with the output load.
 The shaded areas indicate when the input is permitted to change for predicable output performance.

Fig 8. The data input (D) to clock input (CP) set-up times and clock input (CP) to data input (D) hold times

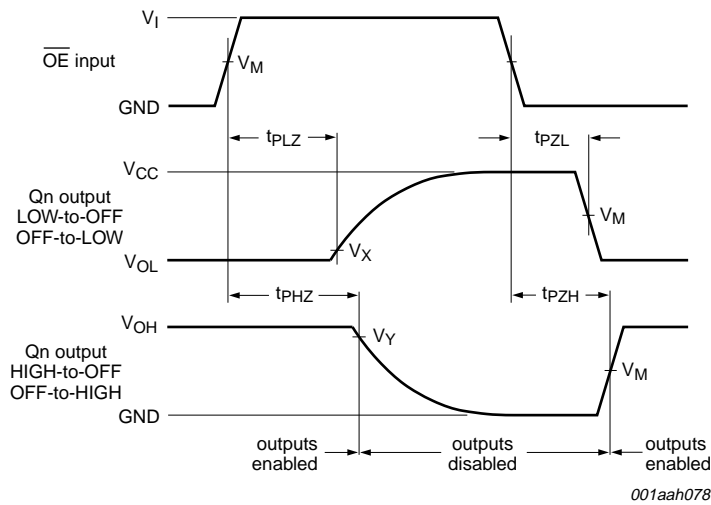

Measurement points are given in [Table 8](#).
 V_{OL} and V_{OH} are typical voltage output levels that occur with the output load.

Fig 9. Enable and disable times

Table 8. Measurement points

Type	Input	Output		
	V_M	V_M	V_X	V_Y
74AHC574	$0.5V_{CC}$	$0.5V_{CC}$	$V_{OL} + 0.3 V$	$V_{OH} - 0.3 V$
74AHCT574	1.5 V	$0.5V_{CC}$	$V_{OL} + 0.3 V$	$V_{OH} - 0.3 V$

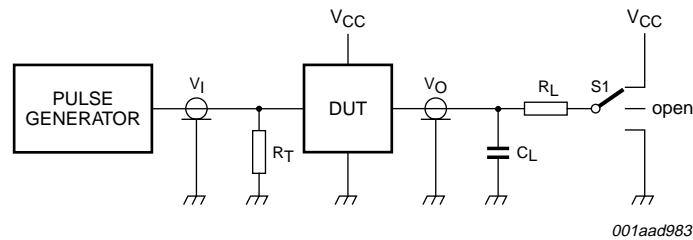

001aad983

Test data is given in [Table 9](#).

Definitions test circuit:

R_T = Termination resistance should be equal to output impedance Z_o of the pulse generator.

C_L = Load capacitance including jig and probe capacitance.

R_L = Load resistance.

S1 = Test selection switch.

Fig 10. Load circuitry for switching times

Table 9. Test data

Type	Input		Load		S1 position		
	V_I	t_r, t_f	C_L	R_L	t_{PHL}, t_{PLH}	t_{PZH}, t_{PHZ}	t_{PZL}, t_{PLZ}
74AHC574	V_{CC}	3.0 ns	15 pF, 50 pF	1 k Ω	open	GND	V_{CC}
74AHCT574	3.0 V	3.0 ns	15 pF, 50 pF	1 k Ω	open	GND	V_{CC}

11. Package outline

SO20: plastic small outline package; 20 leads; body width 7.5 mm

SOT163-1

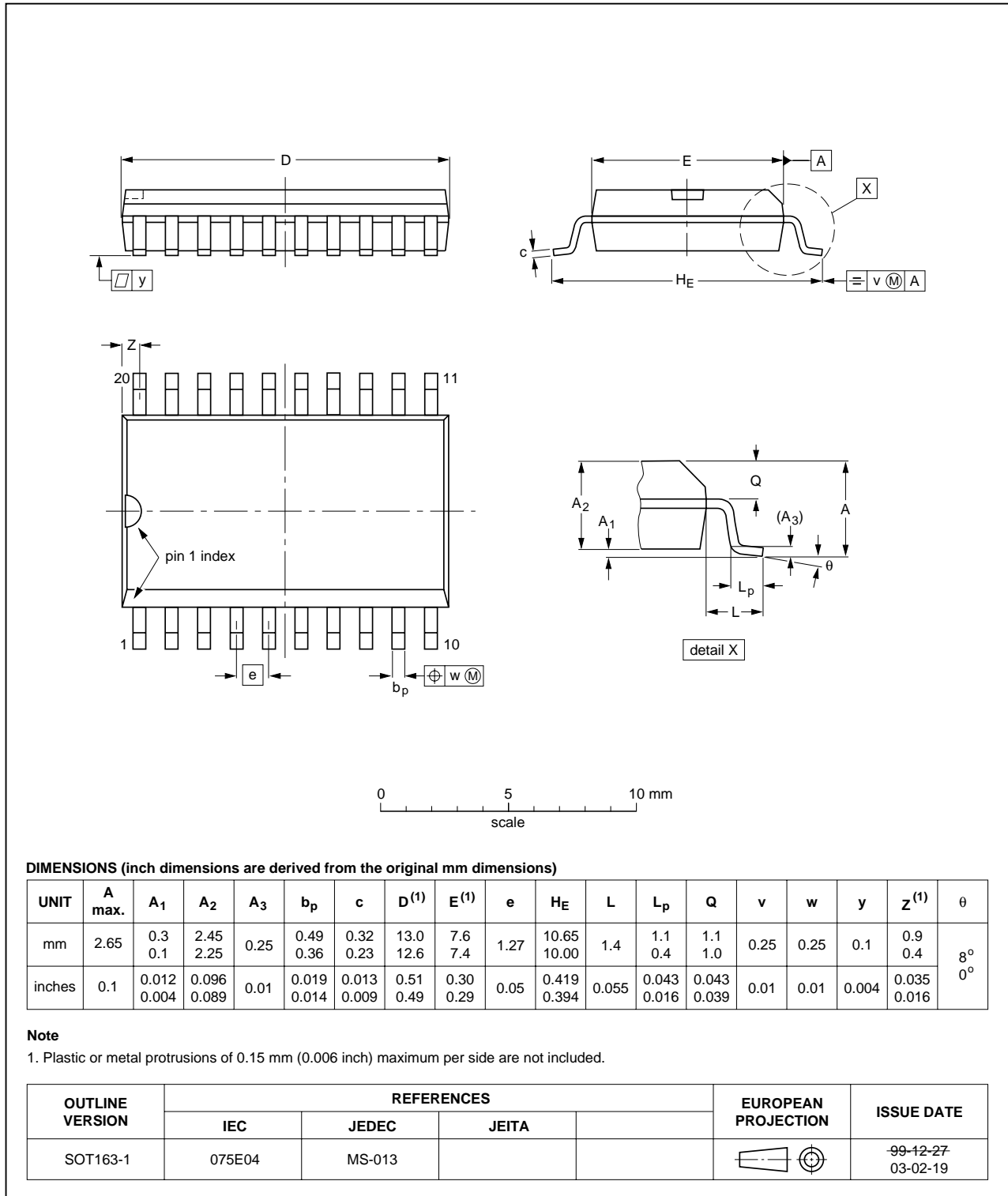

Fig 11. Package outline SOT163-1 (SO20)

TSSOP20: plastic thin shrink small outline package; 20 leads; body width 4.4 mm

SOT360-1



Fig 12. Package outline SOT360-1 (TSSOP20)

DHVQFN20: plastic dual in-line compatible thermal enhanced very thin quad flat package; no leads; 20 terminals; body 2.5 x 4.5 x 0.85 mm

SOT764-1



Fig 13. Package outline SOT764-1 (DHVQFN20)

12. Abbreviations

Table 10. Abbreviations

Acronym	Description
CDM	Charged-Device Model
CMOS	Complementary Metal Oxide Semiconductor
DUT	Device Under Test
ESD	ElectroStatic Discharge
HBM	Human Body Model
MM	Machine Model
TTL	Transistor-Transistor Logic

13. Revision history

Table 11. Revision history

Document ID	Release date	Data sheet status	Change notice	Supersedes
74AHC_AHCT574_2	20080124	Product data sheet	-	74AHC_AHCT574_1
Modifications:	<ul style="list-style-type: none"> • The format of this data sheet has been redesigned to comply with the new identity guidelines of NXP Semiconductors. • Legal texts have been adapted to the new company name where appropriate. • Section 3: DHVQFN20 package added. • Section 7: derating values added for DHVQFN20 package. • Section 11: outline drawing added for DHVQFN20 package. 			
74AHC_AHCT574_1	19990616	Product specification	-	-

14. Legal information

14.1 Data sheet status

Document status ^{[1][2]}	Product status ^[3]	Definition
Objective [short] data sheet	Development	This document contains data from the objective specification for product development.
Preliminary [short] data sheet	Qualification	This document contains data from the preliminary specification.
Product [short] data sheet	Production	This document contains the product specification.

[1] Please consult the most recently issued document before initiating or completing a design.

[2] The term 'short data sheet' is explained in section "Definitions".

[3] The product status of device(s) described in this document may have changed since this document was published and may differ in case of multiple devices. The latest product status information is available on the Internet at URL <http://www.nexperia.com>.

14.2 Definitions

Draft — The document is a draft version only. The content is still under internal review and subject to formal approval, which may result in modifications or additions. Nexperia does not give any representations or warranties as to the accuracy or completeness of information included herein and shall have no liability for the consequences of use of such information.

Short data sheet — A short data sheet is an extract from a full data sheet with the same product type number(s) and title. A short data sheet is intended for quick reference only and should not be relied upon to contain detailed and full information. For detailed and full information see the relevant full data sheet, which is available on request via the local Nexperia sales office. In case of any inconsistency or conflict with the short data sheet, the full data sheet shall prevail.

14.3 Disclaimers

General — Information in this document is believed to be accurate and reliable. However, Nexperia does not give any representations or warranties, expressed or implied, as to the accuracy or completeness of such information and shall have no liability for the consequences of use of such information.

Right to make changes — Nexperia reserves the right to make changes to information published in this document, including without limitation specifications and product descriptions, at any time and without notice. This document supersedes and replaces all information supplied prior to the publication hereof.

Suitability for use — Nexperia products are not designed, authorized or warranted to be suitable for use in medical, military, aircraft, space or life support equipment, nor in applications where failure or

malfunction of a Nexperia product can reasonably be expected to result in personal injury, death or severe property or environmental damage. Nexperia accepts no liability for inclusion and/or use of Nexperia products in such equipment or applications and therefore such inclusion and/or use is at the customer's own risk.

Applications — Applications that are described herein for any of these products are for illustrative purposes only. Nexperia makes no representation or warranty that such applications will be suitable for the specified use without further testing or modification.

Limiting values — Stress above one or more limiting values (as defined in the Absolute Maximum Ratings System of IEC 60134) may cause permanent damage to the device. Limiting values are stress ratings only and operation of the device at these or any other conditions above those given in the Characteristics sections of this document is not implied. Exposure to limiting values for extended periods may affect device reliability.

Terms and conditions of sale — Nexperia products are sold subject to the general terms and conditions of commercial sale, as published at <http://www.nexperia.com/profile/terms>, including those pertaining to warranty, intellectual property rights infringement and limitation of liability, unless explicitly otherwise agreed to in writing by Nexperia. In case of any inconsistency or conflict between information in this document and such terms and conditions, the latter will prevail.

No offer to sell or license — Nothing in this document may be interpreted or construed as an offer to sell products that is open for acceptance or the grant, conveyance or implication of any license under any copyrights, patents or other industrial or intellectual property rights.

14.4 Trademarks

Notice: All referenced brands, product names, service names and trademarks are the property of their respective owners.

15. Contact information

For more information, please visit: <http://www.nexperia.com>

For sales office addresses, please send an email to: salesaddresses@nexperia.com

16. Contents

1	General description	1
2	Features	1
3	Ordering information	2
4	Functional diagram	2
5	Pinning information	4
5.1	Pinning	4
5.2	Pin description	4
6	Functional description	5
7	Limiting values	5
8	Recommended operating conditions	6
9	Static characteristics	6
10	Dynamic characteristics	8
10.1	Waveforms	10
11	Package outline	13
12	Abbreviations	16
13	Revision history	16
14	Legal information	17
14.1	Data sheet status	17
14.2	Definitions	17
14.3	Disclaimers	17
14.4	Trademarks	17
15	Contact information	17
16	Contents	18