



Is Now Part of



**ON Semiconductor®**

To learn more about ON Semiconductor, please visit our website at  
[www.onsemi.com](http://www.onsemi.com)

Please note: As part of the Fairchild Semiconductor integration, some of the Fairchild orderable part numbers will need to change in order to meet ON Semiconductor's system requirements. Since the ON Semiconductor product management systems do not have the ability to manage part nomenclature that utilizes an underscore (\_), the underscore (\_) in the Fairchild part numbers will be changed to a dash (-). This document may contain device numbers with an underscore (\_). Please check the ON Semiconductor website to verify the updated device numbers. The most current and up-to-date ordering information can be found at [www.onsemi.com](http://www.onsemi.com). Please email any questions regarding the system integration to [Fairchild\\_questions@onsemi.com](mailto:Fairchild_questions@onsemi.com).

ON Semiconductor and the ON Semiconductor logo are trademarks of Semiconductor Components Industries, LLC dba ON Semiconductor or its subsidiaries in the United States and/or other countries. ON Semiconductor owns the rights to a number of patents, trademarks, copyrights, trade secrets, and other intellectual property. A listing of ON Semiconductor's product/patent coverage may be accessed at [www.onsemi.com/site/pdf/Patent-Marking.pdf](http://www.onsemi.com/site/pdf/Patent-Marking.pdf). ON Semiconductor reserves the right to make changes without further notice to any products herein. ON Semiconductor makes no warranty, representation or guarantee regarding the suitability of its products for any particular purpose, nor does ON Semiconductor assume any liability arising out of the application or use of any product or circuit, and specifically disclaims any and all liability, including without limitation special, consequential or incidental damages. Buyer is responsible for its products and applications using ON Semiconductor products, including compliance with all laws, regulations and safety requirements or standards, regardless of any support or applications information provided by ON Semiconductor. "Typical" parameters which may be provided in ON Semiconductor data sheets and/or specifications can and do vary in different applications and actual performance may vary over time. All operating parameters, including "Typicals" must be validated for each customer application by customer's technical experts. ON Semiconductor does not convey any license under its patent rights nor the rights of others. ON Semiconductor products are not designed, intended, or authorized for use as a critical component in life support systems or any FDA Class 3 medical devices or medical devices with a same or similar classification in a foreign jurisdiction or any devices intended for implantation in the human body. Should Buyer purchase or use ON Semiconductor products for any such unintended or unauthorized application, Buyer shall indemnify and hold ON Semiconductor and its officers, employees, subsidiaries, affiliates, and distributors harmless against all claims, costs, damages, and expenses, and reasonable attorney fees arising out of, directly or indirectly, any claim of personal injury or death associated with such unintended or unauthorized use, even if such claim alleges that ON Semiconductor was negligent regarding the design or manufacture of the part. ON Semiconductor is an Equal Opportunity/Affirmative Action Employer. This literature is subject to all applicable copyright laws and is not for resale in any manner.

# 74ACTQ16646

## 16-Bit Transceiver/Register with 3-STATE Outputs

### General Description

The ACTQ16646 contains sixteen non-inverting bidirectional registered bus transceivers providing multiplexed transmission of data directly from the input bus or from the internal storage registers. Each byte has separate control inputs which can be shorted together for full 16-bit operation. The DIR inputs determine the direction of data flow through the device. The CPAB and CPBA inputs load data into the registers on the LOW-to-HIGH transition. The ACTQ16646 utilizes Fairchild Quiet Series™ technology to guarantee quiet output switching and improved dynamic threshold performance. FACT Quiet Series™ features GTO™ output control and undershoot corrector for superior performance.

### Features

- Utilizes Fairchild FACT Quiet Series technology
- Guaranteed simultaneous switching noise level and dynamic threshold performance
- Guaranteed pin-to-pin output skew
- Independent registers for A and B buses
- Multiplexed real-time and stored data transfers
- Separate control logic for each byte
- 16-bit version of the ACTQ646
- Outputs source/sink 24 mA
- Additional specs for Multiple Output Switching
- Output loading specs for both 50 pF and 250 pF loads

### Ordering Code:

Order Number	Package Number	Package Description
74ACTQ16646SSC	MS56A	56-Lead Shrink Small Outline Package (SSOP), JEDEC MO-118, 0.300" Wide
74ACTQ16646MTD	MTD56	56-Lead Thin Shrink Small Outline Package (TSSOP), JEDEC MO-153, 6.1mm Wide

Device also available in Tape and Reel. Specify by appending suffix letter "X" to the ordering code.

### Logic Symbol

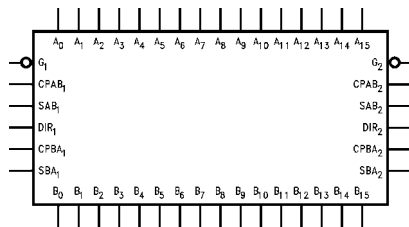

### Connection Diagram

Pin Assignment for SSOP and TSSOP

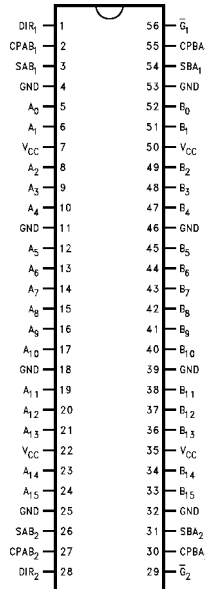

FACT™, Quiet Series™, FACT Quiet Series™ and GTO™ are trademarks of Fairchild Semiconductor Corporation.

## Function Table

Inputs						Data I/O (Note 1)		Output Operation Mode
G <sub>1</sub>	DIR <sub>1</sub>	CPAB <sub>1</sub>	CPBA <sub>1</sub>	SAB <sub>1</sub>	SBA <sub>1</sub>	A <sub>0-7</sub>	B <sub>0-7</sub>	
H	X	H or L	H or L	X	X	Input	Input	Isolation
H	X	↘	X	X	X			Clock An Data into A Register
H	X	X	↘	X	X			Clock Bn Data Into B Register
L	H	X	X	L	X	Input	Output	An to Bn—Real Time (Transparent Mode)
L	H	↘	X	L	X			Clock An Data to A Register
L	H	H or L	X	H	X			A Register to Bn (Stored Mode)
L	H	↘	X	H	X			Clock An Data into A Register and Output to Bn
L	L	X	X	X	L	Output	Input	Bn to An—Real Time (Transparent Mode)
L	L	X	↘	X	L			Clock Bn Data into B Register
L	L	X	H or L	X	H			B Register to An (Stored Mode)
L	L	X	↘	X	H			Clock Bn into B Register and Output to An

H = HIGH Voltage Level    X = Immaterial  
L = LOW Voltage Level    ↘ = LOW-to-HIGH Transition.

**Note 1:** The data output functions may be enabled or disabled by various signals at the G and DIR inputs. Data input functions are always enabled; i.e., data at the bus pins will be stored on every LOW-to-HIGH transition of the appropriate clock inputs. Also applies to data I/O (A and B: 8-15) and #2 control pins.

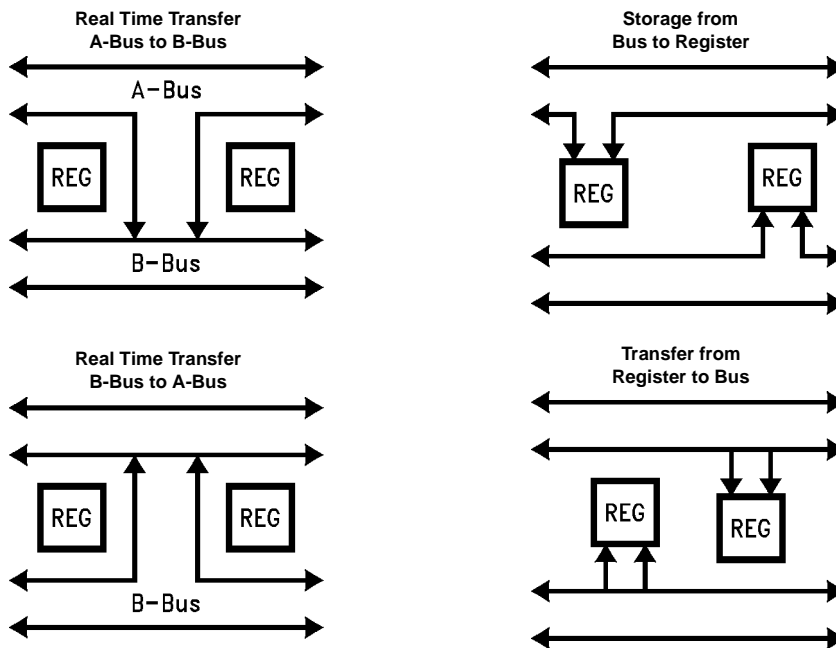

# Logic Diagram

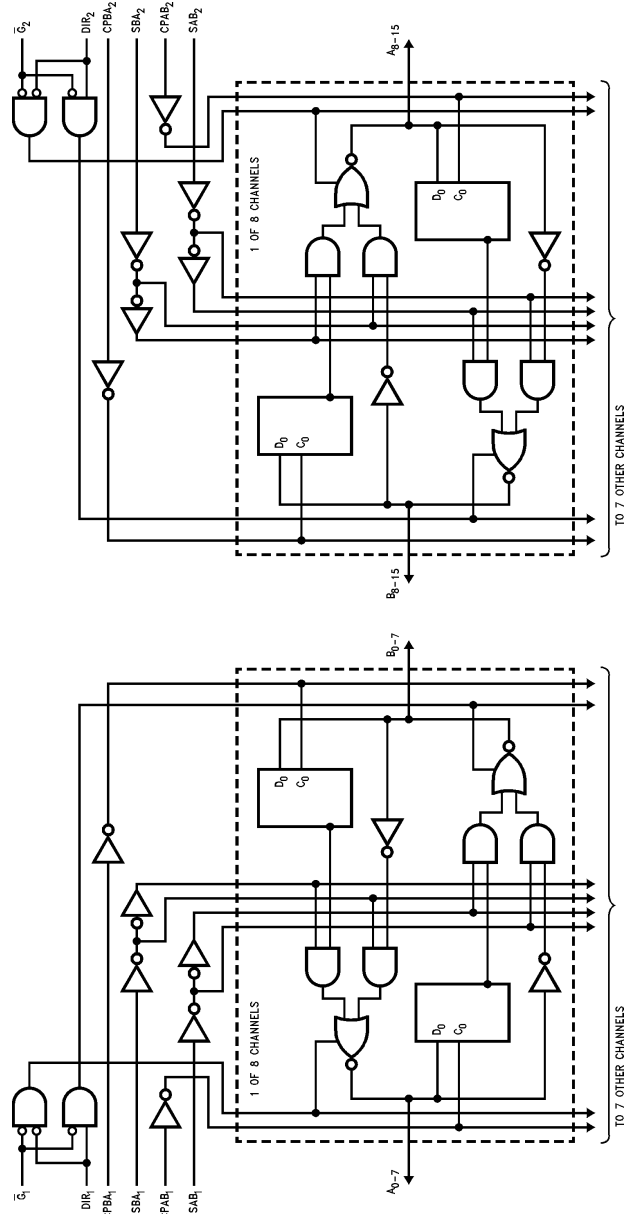

74ACTQ16646

**Absolute Maximum Ratings** (Note 2)

Supply Voltage ( $V_{CC}$ )	-0.5V to +7.0V
DC Input Diode Current ( $I_{IK}$ )	
$V_I = -0.5V$	-20 mA
$V_I = V_{CC} + 0.5V$	+20 mA
DC Output Diode Current ( $I_{OK}$ )	
$V_O = -0.5V$	-20 mA
$V_O = V_{CC} + 0.5V$	+20 mA
DC Output Voltage ( $V_O$ )	-0.5V to $V_{CC} + 0.5V$
DC Output Source/Sink Current ( $I_O$ )	±50 mA
DC $V_{CC}$ or Ground Current	
per Output Pin	±50 mA
Storage Temperature	-65°C to +150°C

**Recommended Operating Conditions**

Supply Voltage ( $V_{CC}$ )	4.5V to 5.5V
Input Voltage ( $V_I$ )	0V to $V_{CC}$
Output Voltage ( $V_O$ )	0V to $V_{CC}$
Operating Temperature ( $T_A$ )	-40°C to +85°C
Minimum Input Edge Rate ( $\Delta V/\Delta t$ )	125 mV/ns
$V_{IN}$ from 0.8V to 2.0V	
$V_{CC}$ @ 4.5V, 5.5V	

**Note 2:** Absolute maximum ratings are those values beyond which damage to the device may occur. The databook specifications should be met, without exception to ensure that the system design is reliable over its power supply, temperature, and output/input loading variables. Fairchild does not recommend operation of FACT™ circuits outside databook specifications.

**DC Electrical Characteristics**

Symbol	Parameter	$V_{CC}$ (V)	$T_A = +25^\circ\text{C}$		$T_A = -40^\circ\text{C to } +85^\circ\text{C}$		Units	Conditions
			Typ	Guaranteed Limits				
$V_{IH}$	Minimum HIGH Input Voltage	4.5	1.5	2.0	2.0	V	$V_{OUT} = 0.1V$ or $V_{CC} - 0.1V$	
		5.5	1.5	2.0	2.0			
$V_{IL}$	Maximum LOW Input Voltage	4.5	1.5	0.8	0.8	V	$V_{OUT} = 0.1V$ or $V_{CC} - 0.1V$	
		5.5	1.5	0.8	0.8			
$V_{OH}$	Minimum HIGH Output Voltage	4.5	4.49	4.4	4.4	V	$I_{OUT} = -50 \mu A$	
		5.5	5.49	5.4	5.4			
		4.5		3.86	3.76	V	$V_{IN} = V_{IL}$ or $V_{IH}$ $I_{OH} = -24 \text{ mA}$ $I_{OH} = -24 \text{ mA (Note 3)}$	
		5.5		4.86	4.76			
$V_{OL}$	Maximum LOW Output Voltage	4.5	0.001	0.1	0.1	V	$I_{OUT} = 50 \mu A$	
		5.5	0.001	0.1	0.1			
		4.5		0.36	0.44	V	$V_{IN} = V_{IL}$ or $V_{IH}$ $I_{OL} = 24 \text{ mA}$ $I_{OL} = 24 \text{ mA (Note 3)}$	
		5.5		0.36	0.44			
$I_{OZT}$	Maximum I/O Leakage Current	5.5		±0.5	±5.0	μA	$V_{IN} = V_{IL}, V_{IH}$ $V_O = V_{CC}, \text{GND}$	
$I_{IN}$	Maximum Input Leakage Current	5.5		±0.1	±1.0	μA	$V_I = V_{CC}, \text{GND}$	
$I_{CCT}$	Maximum $I_{CC}/\text{Input}$	5.5	0.6		1.5	mA	$V_I = V_{CC} - 2.1V$	
$I_{CC}$	Max Quiescent Supply Current	5.5		8.0	80.0	μA	$V_{IN} = V_{CC}$ or GND	
$I_{OLD}$	Minimum Dynamic Output Current (Note 4)	5.5			75	mA	$V_{OLD} = 1.65V \text{ Max}$	
$I_{OHD}$	Output Current (Note 4)				-75	mA	$V_{OHD} = 3.85V \text{ Min}$	
$V_{OLP}$	Quick Output Maximum Dynamic $V_{OL}$	5.0	0.5	0.8		V	Figure 1, Figure 2 (Note 6)(Note 7)	
$V_{OLV}$	Quick Output Minimum Dynamic $V_{OL}$	5.0	-0.5	-0.8		V	Figure 1, Figure 2 (Note 6)(Note 7)	
$V_{OHP}$	Maximum Overshoot	5.0	$V_{OH} + 1.0$	$V_{OH} + 1.5$		V	Figure 1, Figure 2 (Note 5)(Note 7)	
$V_{OHV}$	Minimum $V_{CC}$ Droop	5.0	$V_{OH} - 1.0$	$V_{OH} - 1.8$		V	Figure 1, Figure 2 (Note 5)(Note 7)	
$V_{IHD}$	Minimum HIGH Dynamic Input Voltage Level	5.0	1.7	2.0		V	(Note 5)(Note 8)	
$V_{ILD}$	Maximum LOW Dynamic Input Voltage Level	5.0	1.2	0.8		V	(Note 5)(Note 8)	

**Note 3:** All outputs loaded; thresholds associated with output under test.

**Note 4:** Maximum test duration 2.0 ms; one output loaded at a time.

**Note 5:** Worst case package.

**DC Electrical Characteristics** (Continued)

**Note 6:** Maximum number of outputs that can switch simultaneously is n. (n – 1) outputs are switched LOW and one output held LOW.

**Note 7:** Maximum number of outputs that can switch simultaneously is n. (n – 1) outputs are switched HIGH and one output held HIGH.

**Note 8:** Maximum number of data inputs (n) switching. (n – 1) inputs switching 0V to 3V (ACTQ). Input under test switching 3V to threshold ( $V_{ILD}$ ).

**AC Electrical Characteristics**

Symbol	Parameter	$V_{CC}$ (V) (Note 9)	$T_A = +25^\circ\text{C}$ $C_L = 50\text{ pF}$			$T_A = -40^\circ\text{C to } +85^\circ\text{C}$ $C_L = 50\text{ pF}$		Units
			Min	Typ	Max	Min	Max	
$t_{PHL}$	Propagation Delay	5.0	4.6	6.9	9.4	3.6	10.1	ns
$t_{PLH}$	Clock to Bus		4.3	6.5	8.9	3.3	9.7	
$t_{PHL}$	Propagation Delay	5.0	4.0	6.2	8.5	2.9	9.2	ns
$t_{PLH}$	Bus to Bus		4.1	6.4	8.6	3.2	9.3	
$t_{PHL}$	Propagation Delay	5.0	4.0	6.4	8.9	3.1	9.6	ns
$t_{PLH}$	Select to Bus (w/An or Bn HIGH or LOW)		4.2	6.7	9.5	3.2	10.4	
$t_{PZL}$	Enable Time	5.0	5.3	7.8	10.5	3.8	11.4	ns
$t_{PZH}$	G to An/Bn		4.6	6.9	9.4	3.3	10.2	
$t_{PLZ}$	Disable Time	5.0	3.0	5.5	8.1	2.3	8.6	ns
$t_{PHZ}$	G to An/Bn		3.4	5.7	8.3	2.6	8.6	
$t_{PZL}$	Enable Time	5.0	5.1	8.2	11.8	4.3	12.7	ns
$t_{PZH}$	DIR to An/Bn		4.6	7.5	10.8	3.7	11.7	
$t_{PLZ}$	Disable Time	5.0	2.9	5.8	9.2	2.0	9.8	ns
$t_{PHZ}$	DIR to An/Bn		3.4	6.1	9.2	2.5	9.7	

**Note 9:** Voltage Range 5.0 is  $5.0V \pm 0.5V$ .

**AC Operating Requirements**

Symbol	Parameter	$V_{CC}$ (V) (Note 10)	$T_A = +25^\circ\text{C}$ $C_L = 50\text{ pF}$	$T_A = -40^\circ\text{C to } +85^\circ\text{C}$ $C_L = 50\text{ pF}$	Units
			Guaranteed Minimum		
$t_S$	Setup Time, H or L Bus to Clock	5.0	3.0	3.0	ns
$t_H$	Hold Time, H or L Bus to Clock	5.0	1.5	1.5	ns
$t_W$	Clock Pulse Width H or L	5.0	4.0	4.0	ns

**Note 10:** Voltage Range 5.0 is  $5.0V \pm 0.5V$ .

Extended AC Electrical Characteristics							
Symbol	Parameter	T <sub>A</sub> = -40°C to +85°C V <sub>CC</sub> = Com C <sub>L</sub> = 50 pF 16 Outputs Switching (Note 12)			T <sub>A</sub> = -40°C to +85°C V <sub>CC</sub> = Com C <sub>L</sub> = 250 pF (Note 13)		Units
		Min	Typ	Max	Min	Max	
t <sub>PHL</sub>	Propagation Delay	4.1		10.1	6.1	14.5	ns
t <sub>PLH</sub>	Clock to Bus	4.2		10.1	6.0	14.8	
t <sub>PHL</sub>	Propagation Delay	4.0		10.0	5.4	13.7	ns
t <sub>PLH</sub>	Bus to Bus	4.7		10.7	5.9	13.5	
t <sub>PHL</sub>	Propagation Delay	3.8		9.6	5.7	14.2	ns
t <sub>PLH</sub>	Select to Bus (w/An or Bn HIGH or LOW)	4.3		10.9	6.1	15.5	
t <sub>PZL</sub>	Enable Time	5.0		12.7	(Note 14)		ns
t <sub>PZH</sub>	G to An/Bn	4.1		11.3	(Note 14)		
t <sub>PLZ</sub>	Disable Time	3.2		8.3	(Note 15)		ns
t <sub>PHZ</sub>	G to An/Bn	3.5		8.6	(Note 15)		
t <sub>PZL</sub>	Enable Time	4.1		11.3	(Note 14)		ns
t <sub>PZH</sub>	DIR to An/Bn	4.4		13.0	(Note 14)		
t <sub>PLZ</sub>	Disable Time	2.9		9.5	(Note 15)		ns
t <sub>PHZ</sub>	DIR to An/Bn	3.4		9.7	(Note 15)		
t <sub>OSHL</sub> (Note 11)	Pin-to-Pin Skew Clock to Bus			1.0			ns
t <sub>OSLH</sub> (Note 11)	Pin-to-Pin Skew Clock to Bus			1.0			ns
t <sub>OSHL</sub> (Note 11)	Pin-to-Pin Skew Bus to Bus			1.0			ns
t <sub>OSLH</sub> (Note 11)	Pin-to-Pin Skew Bus to Bus			1.0			ns
t <sub>OSHL</sub> (Note 11)	Pin-to-Pin Skew Select to Bus (w/An or Bn HIGH or LOW)			1.0			ns
t <sub>OSLH</sub> (Note 11)	Pin-to-Pin Skew Select to Bus (w/An or Bn HIGH or LOW)			1.2			ns
t <sub>OST</sub> (Note 11)	Pin-to-Pin Skew Clock to Bus			2.1			ns
t <sub>OST</sub> (Note 11)	Pin-to-Pin Skew Bus to Bus			1.0			ns
t <sub>OST</sub> (Note 11)	Pin-to-Pin Skew Select to Bus			2.7			ns

**Note 11:** Skew is defined as the absolute value of the difference between the actual propagation delays for any two separate outputs of the same device. The specification applies to any outputs switching HIGH to LOW (t<sub>OSHL</sub>), LOW to HIGH (t<sub>OSLH</sub>), or any combination switching LOW to HIGH and/or HIGH to LOW (t<sub>OST</sub>).

**Note 12:** This specification is guaranteed but not tested. The limits apply to propagation delays for all paths described switching in phase (i.e., all LOW-to-HIGH, HIGH-to-LOW, etc.).

**Note 13:** This specification is guaranteed but not tested. The limits represent propagation delays with 250 pF load capacitors in place of the 50 pF load capacitors in the standard AC load. This specification pertains to single output switching only.

**Note 14:** 3-STATE delays are load dominated and have been excluded from the datasheet.

**Note 15:** The Output Disable Time is dominated by the RC network (500Ω, 250 pF) on the output and has been excluded from the datasheet.

### Capacitance

Symbol	Parameter	Typ	Units	Conditions
C <sub>IN</sub>	Input Capacitance	4.5	pF	V <sub>CC</sub> = 5.0V
C <sub>PD</sub>	Power Dissipation Capacitance	95	pF	V <sub>CC</sub> = 5.0V

## FACT Noise Characteristics

The setup of a noise characteristics measurement is critical to the accuracy and repeatability of the tests. The following is a brief description of the setup used to measure the noise characteristics of FACT.

### Equipment:

Hewlett Packard Model 8180A Word Generator  
PC-163A Test Fixture  
Tektronics Model 7854 Oscilloscope

### Procedure:

1. Verify Test Fixture Loading: Standard Load 50 pF, 500Ω.
2. Deskew the HFS generator so that no two channels have greater than 150 ps skew between them. This requires that the oscilloscope be deskewed first. It is important to deskew the HFS generator channels before testing. This will ensure that the outputs switch simultaneously.
3. Terminate all inputs and outputs to ensure proper loading of the outputs and that the input levels are at the correct voltage.
4. Set the HFS generator to toggle all but one output at a frequency of 1 MHz. Greater frequencies will increase DUT heating and effect the results of the measurement.

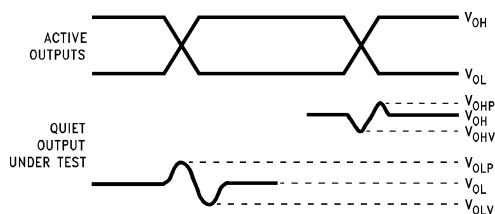

$V_{OHV}$  and  $V_{OLP}$  are measured with respect to ground reference.

Input pulses have the following characteristics:  $f = 1$  MHz,  $t_r = 3$  ns,  $t_f = 3$  ns, skew < 150 ps.

**FIGURE 1. Quiet Output Noise Voltage Waveforms**

5. Set the word generator input levels at 0V LOW and 3V HIGH for ACT devices and 0V LOW and 5V HIGH for AC devices. Verify levels with an oscilloscope.

$V_{OLP}/V_{OLV}$  and  $V_{OHP}/V_{OHV}$ :

- Determine the quiet output pin that demonstrates the greatest noise levels. The worst case pin will usually be the furthest from the ground pin. Monitor the output voltages using a 50Ω coaxial cable plugged into a standard SMB type connector on the test fixture. Do not use an active FET probe.
- Measure  $V_{OLP}$  and  $V_{OLV}$  on the quiet output during the worst case transition for active and enable. Measure  $V_{OHP}$  and  $V_{OHV}$  on the quiet output during the worst case transition for active and enable.
- Verify that the GND reference recorded on the oscilloscope has not drifted to ensure the accuracy and repeatability of the measurements.

$V_{ILD}$  and  $V_{IHD}$ :

- Monitor one of the switching outputs using a 50Ω coaxial cable plugged into a standard SMB type connector on the test fixture. Do not use an active FET probe.
- First increase the input LOW voltage level,  $V_{IL}$ , until the output begins to oscillate or steps out a min of 2 ns. Oscillation is defined as noise on the output LOW level that exceeds  $V_{IL}$  limits, or on output HIGH levels that exceed  $V_{IH}$  limits. The input LOW voltage level at which oscillation occurs is defined as  $V_{ILD}$ .
- Next decrease the input HIGH voltage level,  $V_{IH}$ , until the output begins to oscillate or steps out a min of 2 ns. Oscillation is defined as noise on the output LOW level that exceeds  $V_{IL}$  limits, or on output HIGH levels that exceed  $V_{IH}$  limits. The input HIGH voltage level at which oscillation occurs is defined as  $V_{IHD}$ .
- Verify that the GND reference recorded on the oscilloscope has not drifted to ensure the accuracy and repeatability of the measurements.

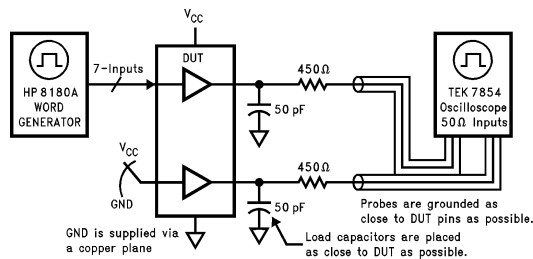
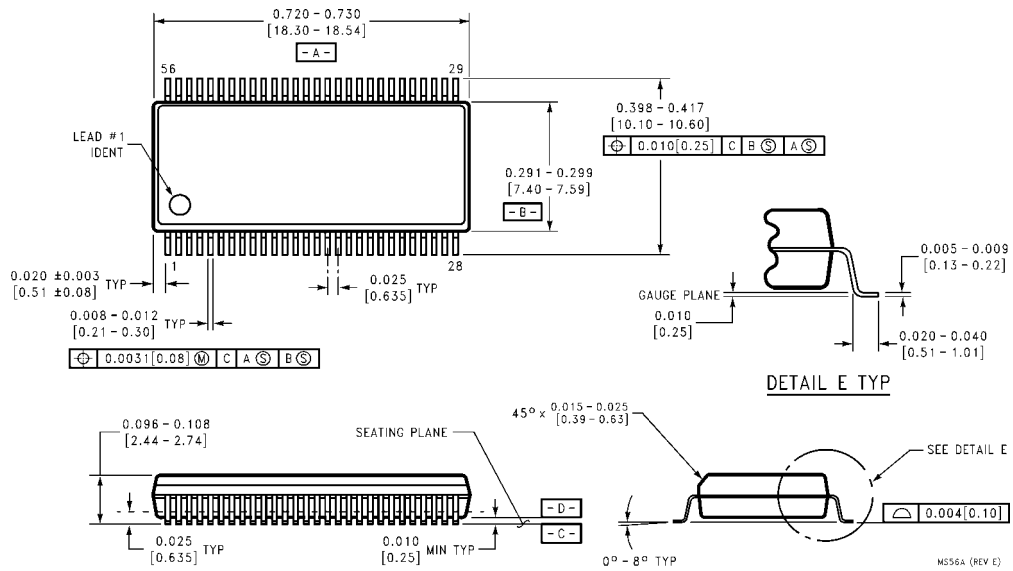

**FIGURE 2. Simultaneous Switching Test Circuit**



74ACTQ16646

**Physical Dimensions** inches (millimeters) unless otherwise noted



**56-Lead Shrink Small Outline Package (SSOP), JEDEC MO-118, 0.300" Wide  
Package Number MS56A**



ON Semiconductor and  are trademarks of Semiconductor Components Industries, LLC dba ON Semiconductor or its subsidiaries in the United States and/or other countries. ON Semiconductor owns the rights to a number of patents, trademarks, copyrights, trade secrets, and other intellectual property. A listing of ON Semiconductor's product/patent coverage may be accessed at [www.onsemi.com/site/pdf/Patent-Marking.pdf](http://www.onsemi.com/site/pdf/Patent-Marking.pdf). ON Semiconductor reserves the right to make changes without further notice to any products herein. ON Semiconductor makes no warranty, representation or guarantee regarding the suitability of its products for any particular purpose, nor does ON Semiconductor assume any liability arising out of the application or use of any product or circuit, and specifically disclaims any and all liability, including without limitation special, consequential or incidental damages. Buyer is responsible for its products and applications using ON Semiconductor products, including compliance with all laws, regulations and safety requirements or standards, regardless of any support or applications information provided by ON Semiconductor. "Typical" parameters which may be provided in ON Semiconductor data sheets and/or specifications can and do vary in different applications and actual performance may vary over time. All operating parameters, including "Typicals" must be validated for each customer application by customer's technical experts. ON Semiconductor does not convey any license under its patent rights nor the rights of others. ON Semiconductor products are not designed, intended, or authorized for use as a critical component in life support systems or any FDA Class 3 medical devices or medical devices with a same or similar classification in a foreign jurisdiction or any devices intended for implantation in the human body. Should Buyer purchase or use ON Semiconductor products for any such unintended or unauthorized application, Buyer shall indemnify and hold ON Semiconductor and its officers, employees, subsidiaries, affiliates, and distributors harmless against all claims, costs, damages, and expenses, and reasonable attorney fees arising out of, directly or indirectly, any claim of personal injury or death associated with such unintended or unauthorized use, even if such claim alleges that ON Semiconductor was negligent regarding the design or manufacture of the part. ON Semiconductor is an Equal Opportunity/Affirmative Action Employer. This literature is subject to all applicable copyright laws and is not for resale in any manner.

## PUBLICATION ORDERING INFORMATION

### LITERATURE FULFILLMENT:

Literature Distribution Center for ON Semiconductor  
19521 E. 32nd Pkwy, Aurora, Colorado 80011 USA  
**Phone:** 303-675-2175 or 800-344-3860 Toll Free USA/Canada  
**Fax:** 303-675-2176 or 800-344-3867 Toll Free USA/Canada  
**Email:** [orderlit@onsemi.com](mailto:orderlit@onsemi.com)

**N. American Technical Support:** 800-282-9855 Toll Free  
USA/Canada  
**Europe, Middle East and Africa Technical Support:**  
Phone: 421 33 790 2910  
**Japan Customer Focus Center**  
Phone: 81-3-5817-1050

**ON Semiconductor Website:** [www.onsemi.com](http://www.onsemi.com)  
**Order Literature:** <http://www.onsemi.com/orderlit>  
For additional information, please contact your local  
Sales Representative