

BAS70 series; 1PS7XSB70 series

General-purpose Schottky diodes

Rev. 10 — 7 April 2021

Product data sheet

1. Product profile

1.1. General description

General-purpose Schottky diodes in small Surface-Mounted Device (SMD) plastic packages.

Table 1. Product overview

Type number	Package		Configuration
	Nexperia	JEITA	
1PS76SB70	SOD323	SC-76	single diode
1PS79SB70	SOD523	SC-79	single diode
BAS70	SOT23	-	single diode
BAS70H	SOD123F	-	single diode
BAS70L	SOD882	-	single diode
BAS70W	SOT323	SC-70	single diode
BAS70-04	SOT23	-	dual series
BAS70-04W	SOT323	SC-70	dual series
BAS70-05	SOT23	-	dual common cathode
BAS70-05W	SOT323	SC-70	dual common cathode
BAS70-06	SOT23	-	dual common anode
BAS70-06W	SOT323	SC-70	dual common anode
BAS70-07	SOT143B	-	dual isolated
BAS70-07S	SOT363	SC-88	dual isolated
BAS70-07V	SOT666	-	dual isolated
BAS70VV	SOT666		triple isolated
BAS70XY	SOT363	SC-88	quadruple; 2 series

1.2. Features and benefits

- High switching speed
- Low leakage current
- High breakdown voltage
- Low capacitance
- AEC-Q101 qualified

1.3. Applications

- Ultra high-speed switching
- Voltage clamping

1.4. Quick reference data



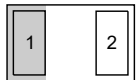

Table 2. Quick reference data

Symbol	Parameter	Conditions	Min	Typ	Max	Unit
Per diode						
I_F	forward current		-	-	70	mA
V_F	forward voltage	$I_F = 1 \text{ mA}$	[1]	-	410	mV
V_R	reverse voltage	$T_j = 25 \text{ °C}$	-	-	70	V

[1] Pulse test: $t_p \leq 300 \text{ }\mu\text{s}$; $\delta \leq 0.02$.

2. Pinning information

Table 3. Pinning

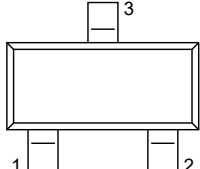
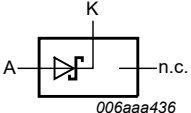
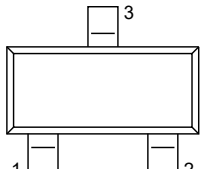
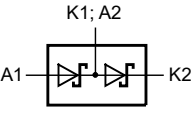
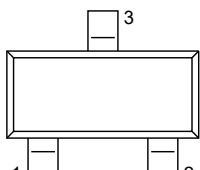
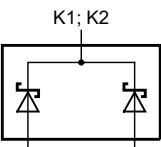
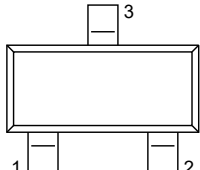
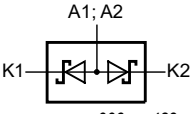
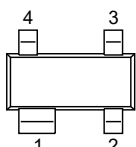
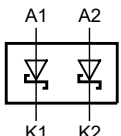
Pin	Symbol	Description		Simplified outline	Symbol
BAS70H; 1PS76SB70; 1PS79SB70					
1	K	cathode	[1]		 sym001
2	A	anode			
BAS70L					
1	K	cathode	[1]	 Transparent top view	 sym001
2	A	anode			
BAS70; BAS70W					
1	A	anode			 006aaa436
2	n.c.	not connected			
3	K	cathode			
BAS70-04; BAS70-04W					
1	A1	anode (diode 1)			 006aaa437
2	K2	cathode (diode 2)			
3	K1; A2	cathode (diode 1), anode (diode 2)			
BAS70-05; BAS70-05W					
1	A1	anode (diode 1)			 006aaa438
2	A2	anode (diode 2)			
3	K1; K2	cathode (diode 1), cathode (diode 2)			
BAS70-06; BAS70-06W					
1	K1	cathode (diode 1)			 006aaa439
2	K2	cathode (diode 2)			
3	A1; A2	anode (diode 1), anode (diode 2)			
BAS70-07					
1	K1	cathode (diode 1)			 006aaa434
2	K2	cathode (diode 2)			
3	A2	anode (diode 2)			
4	A1	anode (diode 1)			

Pin	Symbol	Description	Simplified outline	Symbol
BAS70-07S; BAS70-07V				
1	A1	anode (diode 1)		
2	n.c.	not connected		
3	K2	cathode (diode 2)		
4	A2	anode (diode 2)		
5	n.c.	not connected		
6	K1	cathode (diode 1)		
BAS70VV				
1	A1	anode (diode 1)		
2	A2	anode (diode 2)		
3	A3	anode (diode 3)		
4	K3	cathode (diode 3)		
5	K2	cathode (diode 2)		
6	K1	cathode (diode 1)		
BAS70XY				
1	A1	anode (diode 1)		
2	K2	cathode (diode 2)		
3	A3; K4	anode (diode 3), cathode (diode 4)		
4	A4	anode (diode 4)		
5	K3	cathode (diode 3)		
6	K1; A2	cathode (diode 1), anode (diode 2)		

[1] The marking bar indicates the cathode.

3. Ordering information

Table 4. Ordering information

Type number	Package		
	Name	Description	Version
1PS76SB70	SC-76	plastic surface-mounted package; 2 leads	SOD323
1PS79SB70	SC-79	plastic surface-mounted package; 2 leads	SOD523
BAS70	-	plastic surface-mounted package; 3 leads	SOT23
BAS70H	-	plastic surface-mounted package; 2 leads	SOD123F
BAS70L	-	leadless ultra small plastic package; 2 leads	SOD882
BAS70W	SC-70	plastic surface-mounted package; 3 leads	SOT323
BAS70-04	-	plastic surface-mounted package; 3 leads	SOT23
BAS70-04W	SC-70	plastic surface-mounted package; 3 leads	SOT323
BAS70-05	-	plastic surface-mounted package; 3 leads	SOT23
BAS70-05W	SC-70	plastic surface-mounted package; 3 leads	SOT323
BAS70-06	-	plastic surface-mounted package; 3 leads	SOT23
BAS70-06W	SC-70	plastic surface-mounted package; 3 leads	SOT323
BAS70-07	-	plastic surface-mounted package; 4 leads	SOT143B
BAS70-07S	SC-88	plastic surface-mounted package; 6 leads	SOT363
BAS70-07V	-	plastic surface-mounted package; 6 leads	SOT666
BAS70VV	-	plastic surface-mounted package; 6 leads	SOT666
BAS70XY	SC-88	plastic surface-mounted package; 6 leads	SOT363

4. Marking

Table 5. Marking codes

Type number	Marking code [1]	Type number	Marking code [1]
1PS76SB70	S2	BAS70-05W	75%
1PS79SB70	G	BAS70-06	76%
BAS70	73%	BAS70-06W	76%
BAS70H	AH	BAS70-07	77%
BAS70L	S8	BAS70-07S	77%
BAS70W	73%	BAS70-07V	77
BAS70-04	74%	BAS70VV	N1
BAS70-04W	74%	BAS70XY	70%
BAS70-05	75%	-	-

[1] % indicates the assembly center

5. Limiting values

Table 6. Limiting values

In accordance with the Absolute Maximum Rating System (IEC 60134).

Symbol	Parameter	Conditions	Min	Max	Unit
Per diode					
V_R	reverse voltage	$T_j = 25\text{ °C}$	-	70	V
I_F	forward current		-	70	mA
I_{FRM}	repetitive peak forward current	$t_p \leq 1\text{ s}; \delta \leq 0.5$	-	70	mA
I_{FSM}	non-repetitive peak forward current	$t_p \leq 10\text{ ms}$	[1]	100	mA
T_j	junction temperature		-	150	°C
T_{amb}	ambient temperature		-65	+150	°C
T_{stg}	storage temperature		-65	+150	°C

[1] $T_j = 25\text{ °C}$ prior to surge.

6. Thermal characteristics

Table 7. Thermal characteristics

Symbol	Parameter	Conditions	Min	Typ	Max	Unit
Per device						
$R_{th(j-a)}$	thermal resistance from junction to ambient	in free air	[1]			
	• SOT23		-	-	500	K/W
	• SOT143B		-	-	500	K/W
	• SOT363 (BAS70-07S)		-	-	416	K/W
	• SOT666 (BAS70VV)		[2]	-	700	K/W
	• SOT666 (BAS70-07V)		[2]	-	416	K/W
	• SOD123F		[2]	-	330	K/W
	• SOD323		-	-	450	K/W
	• SOD523		[2]	-	450	K/W
	• SOD882		[2]	-	500	K/W
• SOT323		-	-	625	K/W	
$R_{th(j-sp)}$	thermal resistance from junction to solder point					
	• SOT363 (BAS70XY)		[3]	-	260	K/W

[1] Device mounted on an FR4 Printed-Circuit Board (PCB), single-sided copper, tin-plated and standard footprint.

[2] Reflow soldering is the only recommended soldering method.

[3] Soldering point at pins 2, 3, 5 and 6.

7. Characteristics

Table 8. Characteristics

$T_{amb} = 25\text{ °C}$ unless otherwise specified.

Symbol	Parameter	Conditions	Min	Typ	Max	Unit
Per diode						
V_F	forward voltage		[1]			
		$I_F = 1\text{ mA}$	-	-	410	mV
		$I_F = 10\text{ mA}$	-	-	750	mV
		$I_F = 15\text{ mA}$	-	-	1	V
I_R	reverse current	$V_R = 50\text{ V}$	-	-	100	nA
		$V_R = 70\text{ V}$	-	-	10	μA
C_d	diode capacitance	$V_R = 0\text{ V}; f = 1\text{ MHz}$	-	-	2	pF

[1] Pulse test: $t_p \leq 300\text{ }\mu\text{s}$; $\delta \leq 0.02$.

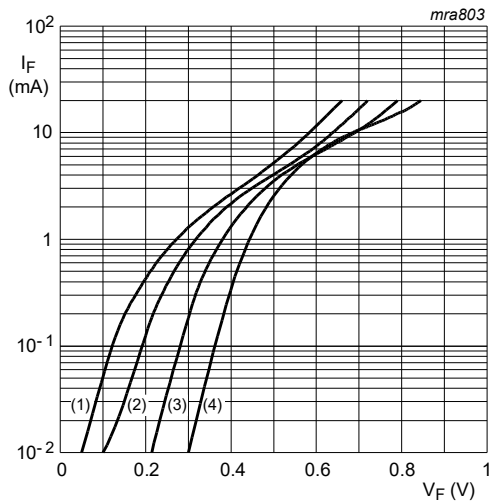

- (1) $T_{\text{amb}} = 125^\circ\text{C}$
- (2) $T_{\text{amb}} = 85^\circ\text{C}$
- (3) $T_{\text{amb}} = 25^\circ\text{C}$
- (4) $T_{\text{amb}} = -40^\circ\text{C}$

Fig. 1. Forward current as a function of forward voltage; typical values

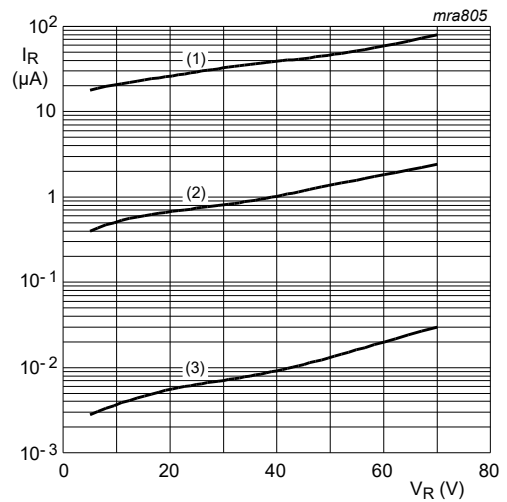

- (1) $T_{\text{amb}} = 125^\circ\text{C}$
- (2) $T_{\text{amb}} = 85^\circ\text{C}$
- (3) $T_{\text{amb}} = 25^\circ\text{C}$

Fig. 2. Reverse current as a function of reverse voltage; typical values

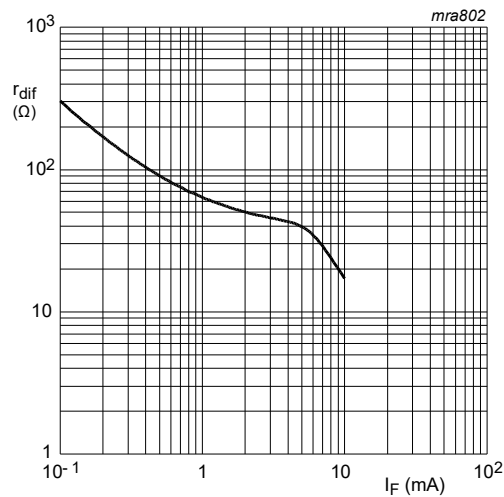

$f = 10\text{ kHz}$

Fig. 3. Differential resistance as a function of forward current; typical values

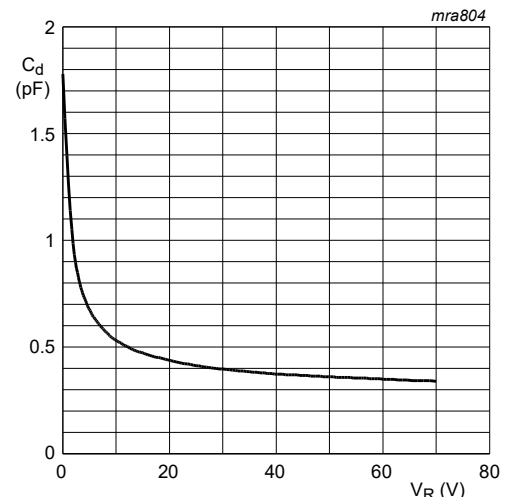

$T_{\text{amb}} = 25^\circ\text{C}; f = 1\text{ MHz}$

Fig. 4. Diode capacitance as a function of reverse voltage; typical values

8. Test information

8.1. Quality information

This product has been qualified in accordance with the Automotive Electronics Council (AEC) standard Q101 - Stress test qualification for discrete semiconductors, and is suitable for use in automotive applications.

9. Package outline

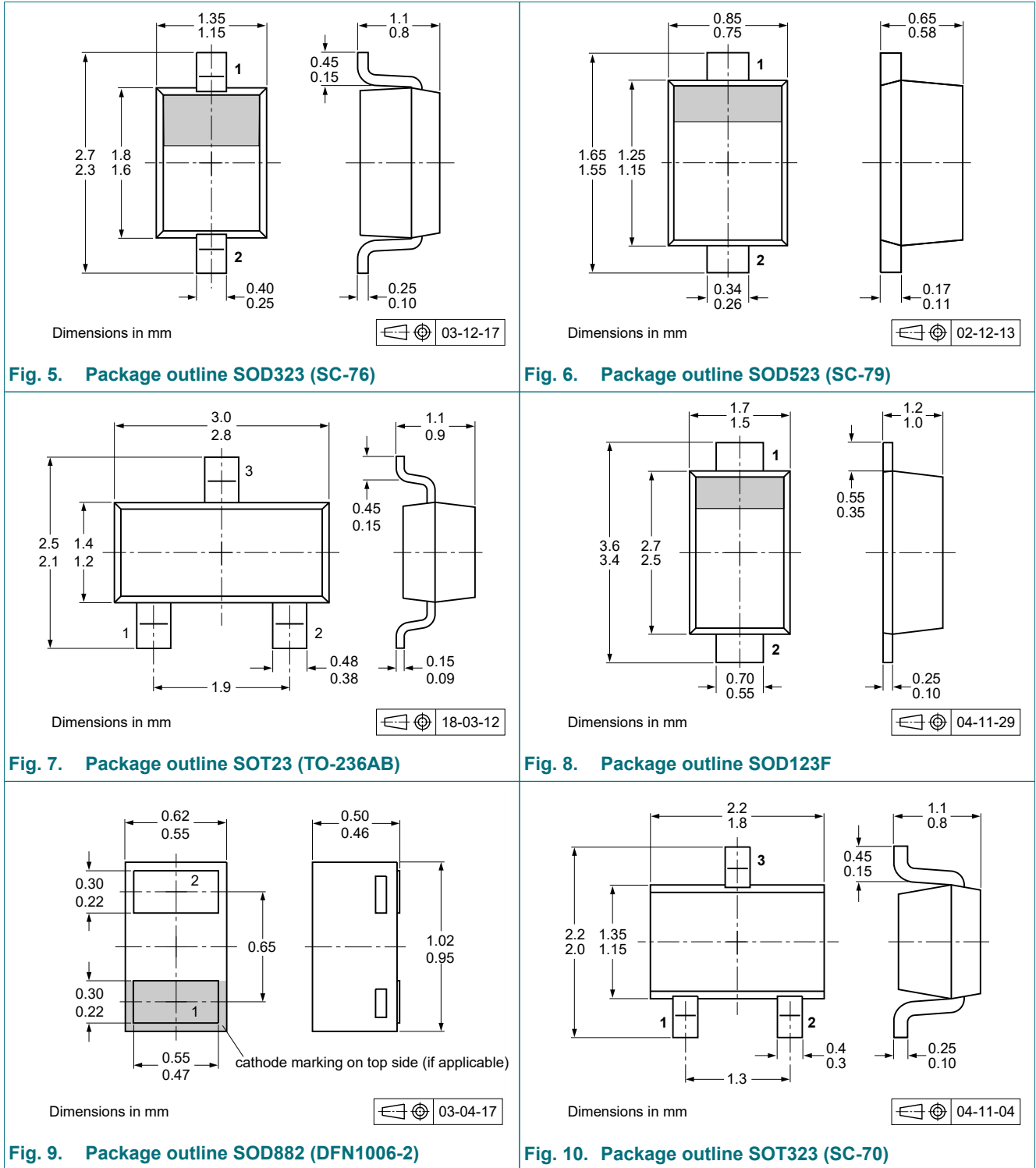

Fig. 5. Package outline SOD323 (SC-76)

Fig. 6. Package outline SOD523 (SC-79)

Fig. 7. Package outline SOT23 (TO-236AB)

Fig. 8. Package outline SOD123F

Fig. 9. Package outline SOD882 (DFN1006-2)

Fig. 10. Package outline SOT323 (SC-70)

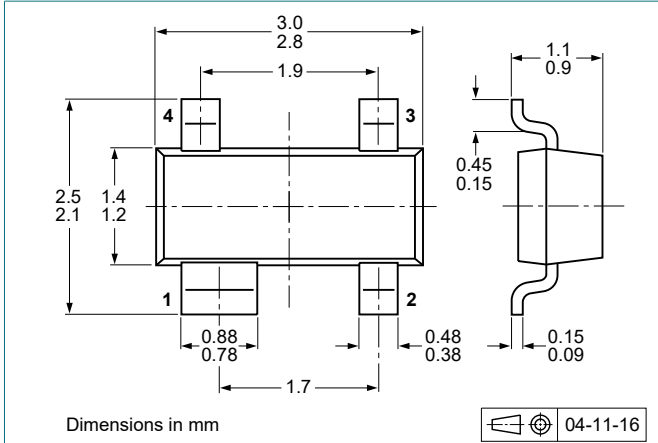

Fig. 11. Package outline SOT143B

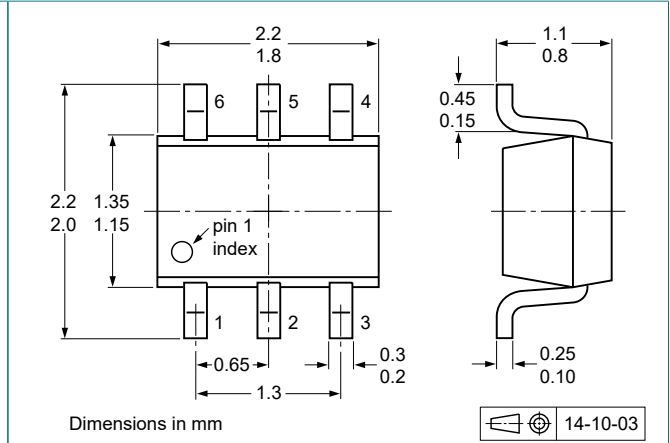

Fig. 12. Package outline SOT363 (SC-88)

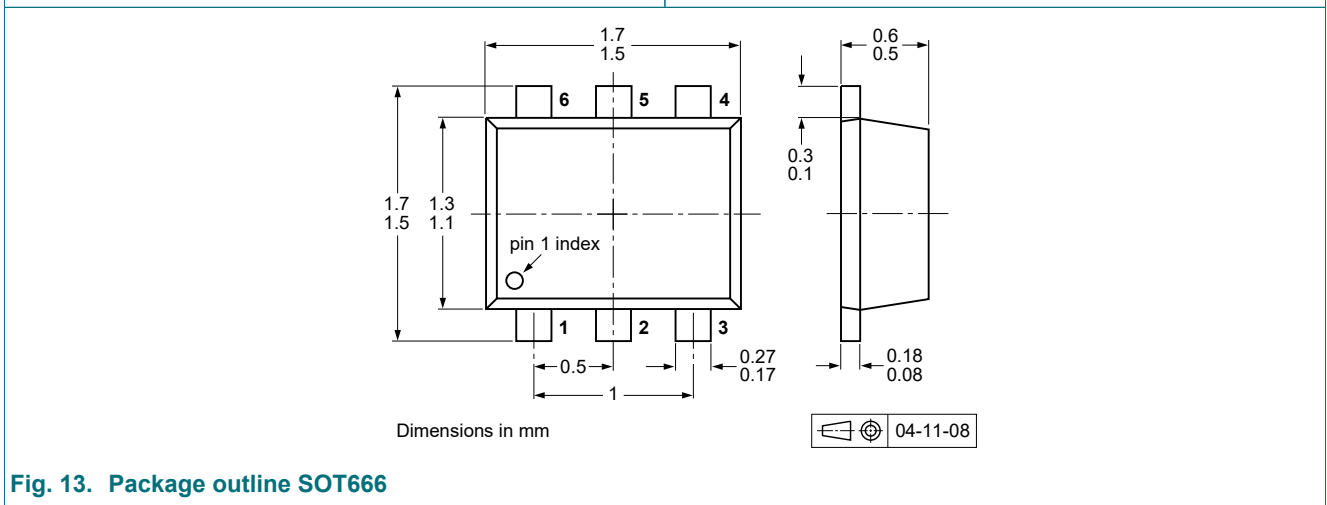

Fig. 13. Package outline SOT666

10. Soldering

Table 9. Soldering

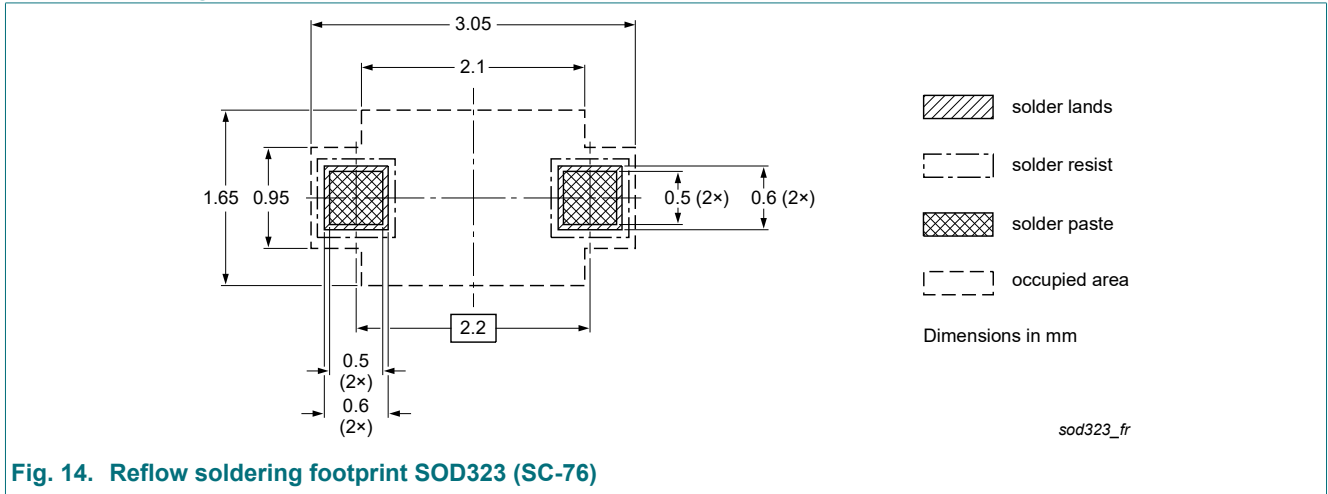

Fig. 14. Reflow soldering footprint SOD323 (SC-76)

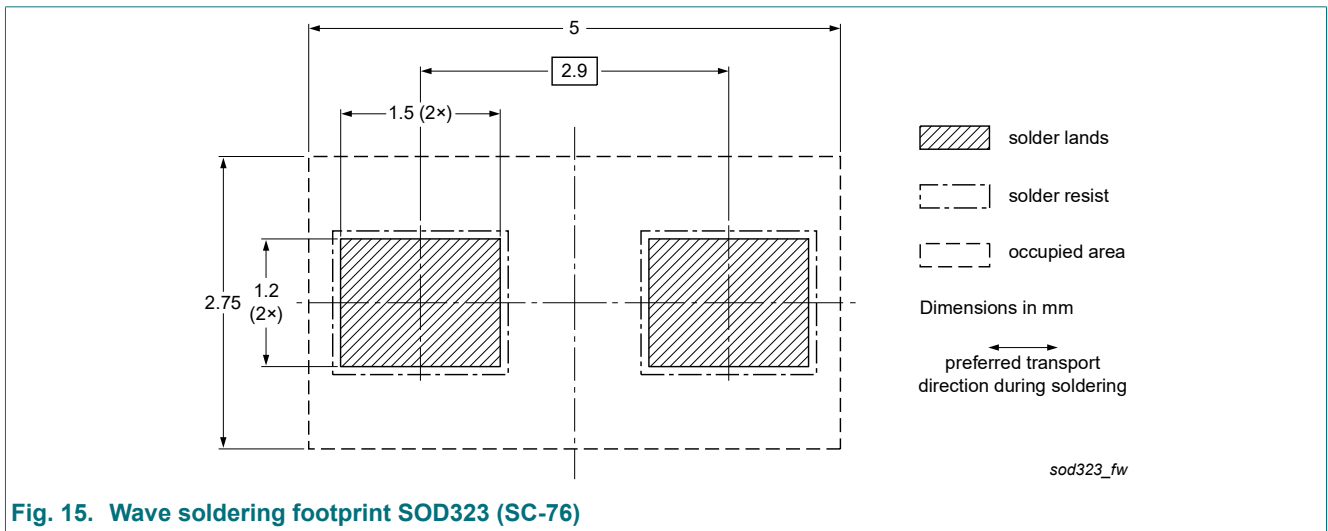

Fig. 15. Wave soldering footprint SOD323 (SC-76)

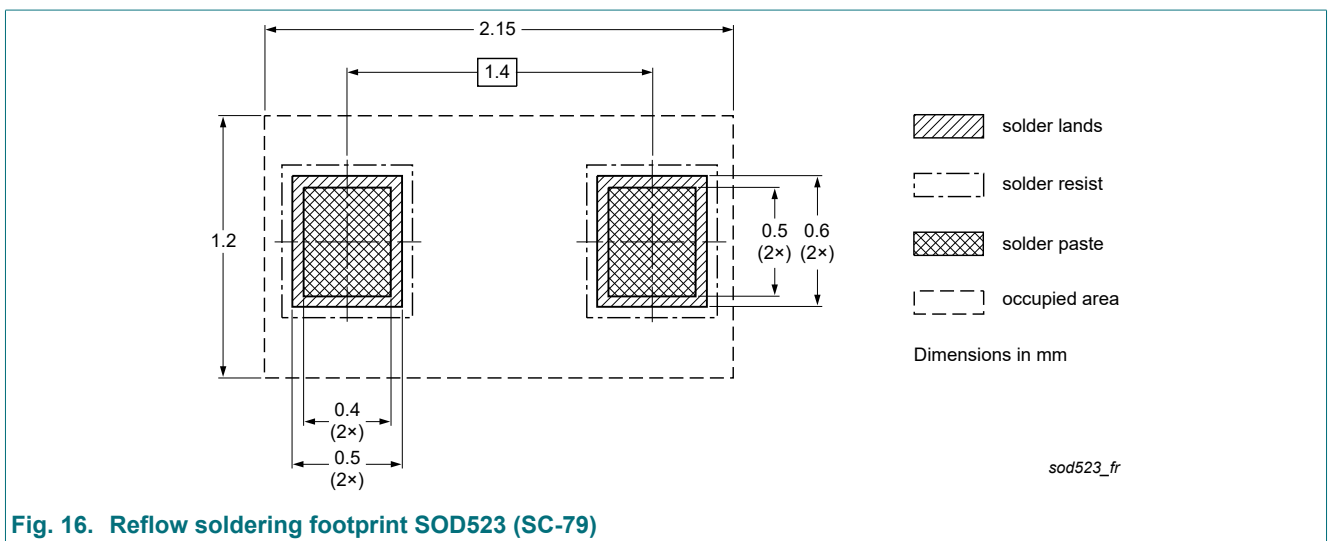

Fig. 16. Reflow soldering footprint SOD523 (SC-79)

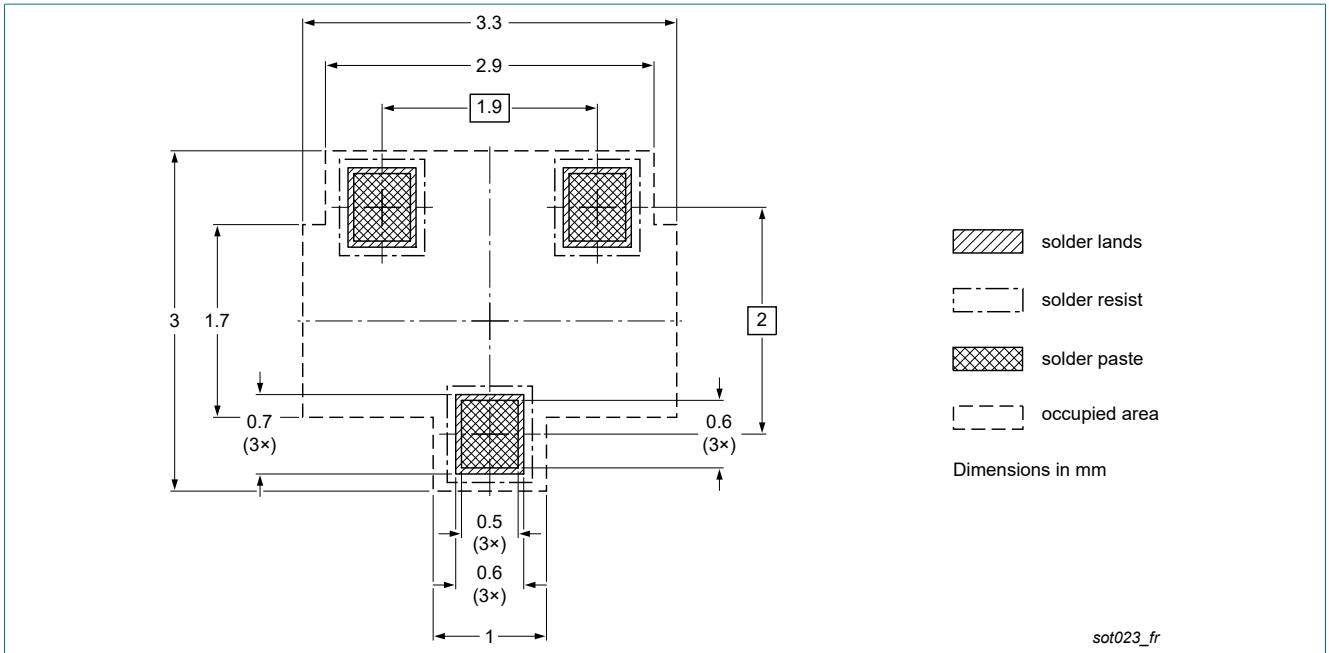

Fig. 17. Reflow soldering footprint SOT23 (TO-236AB)

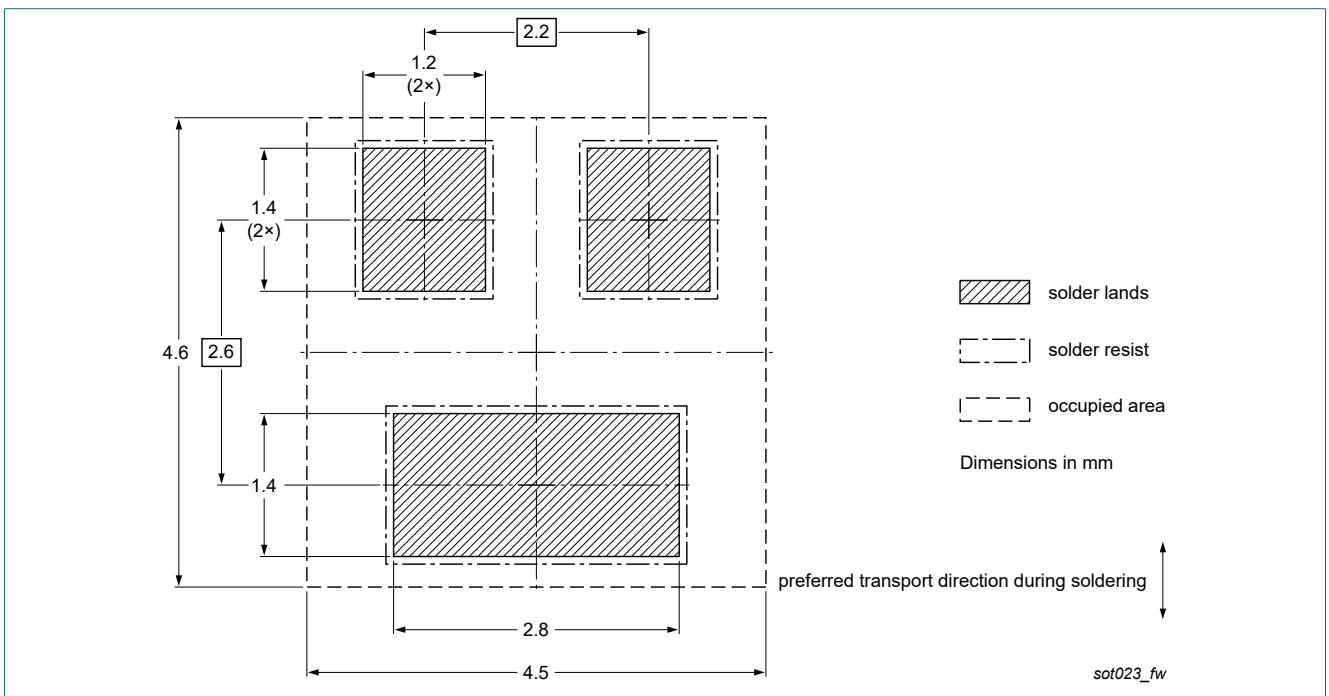

Fig. 18. Wave soldering footprint SOT23 (TO-236AB)

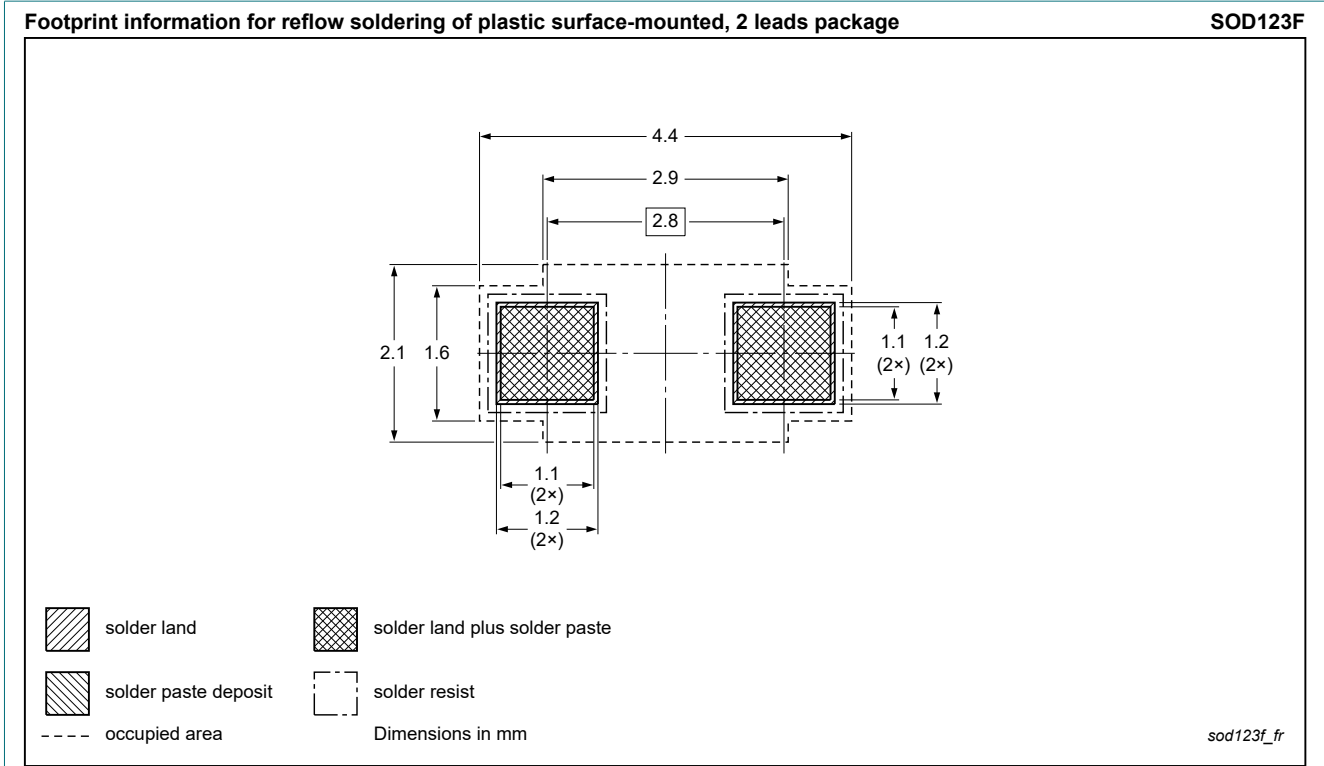

Fig. 19. Reflow soldering footprint SOD123F

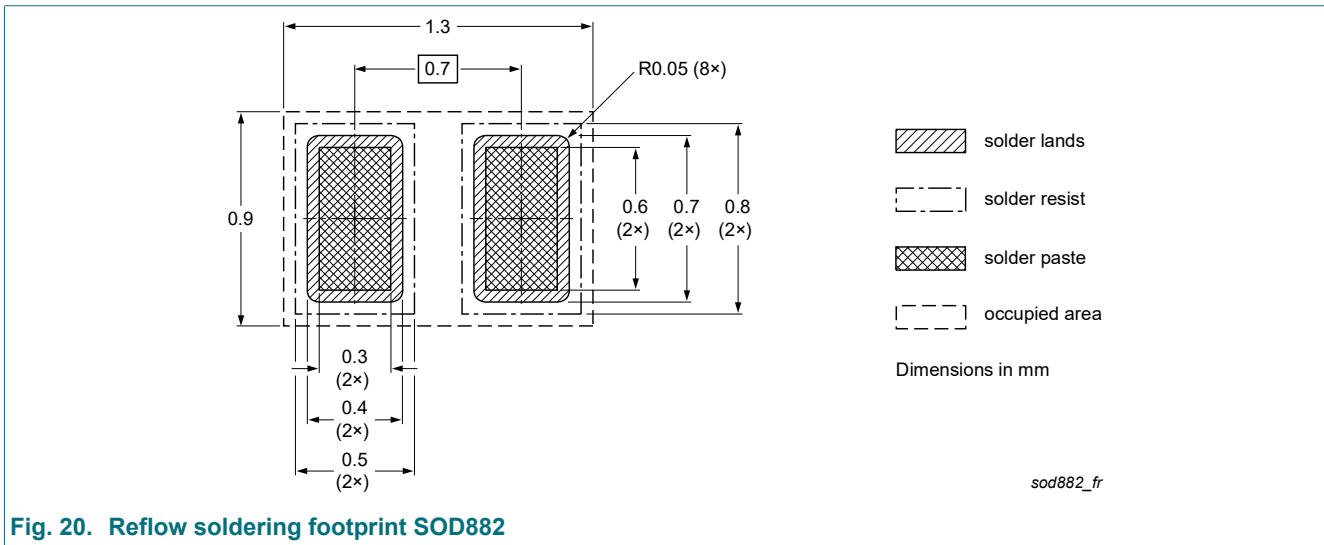

Fig. 20. Reflow soldering footprint SOD882

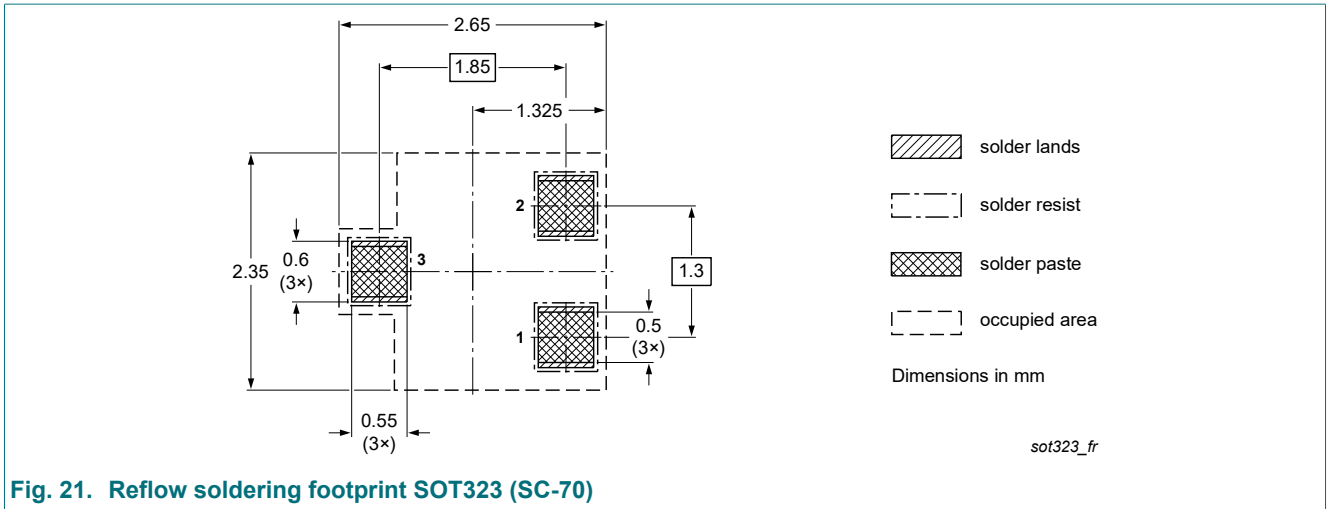

Fig. 21. Reflow soldering footprint SOT323 (SC-70)

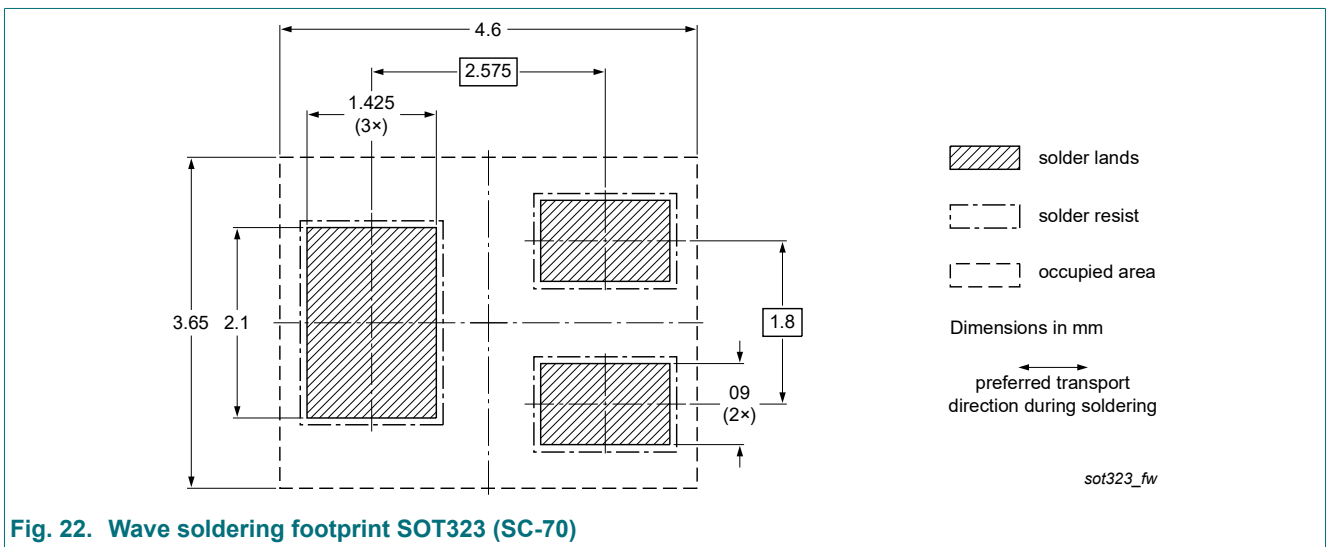

Fig. 22. Wave soldering footprint SOT323 (SC-70)

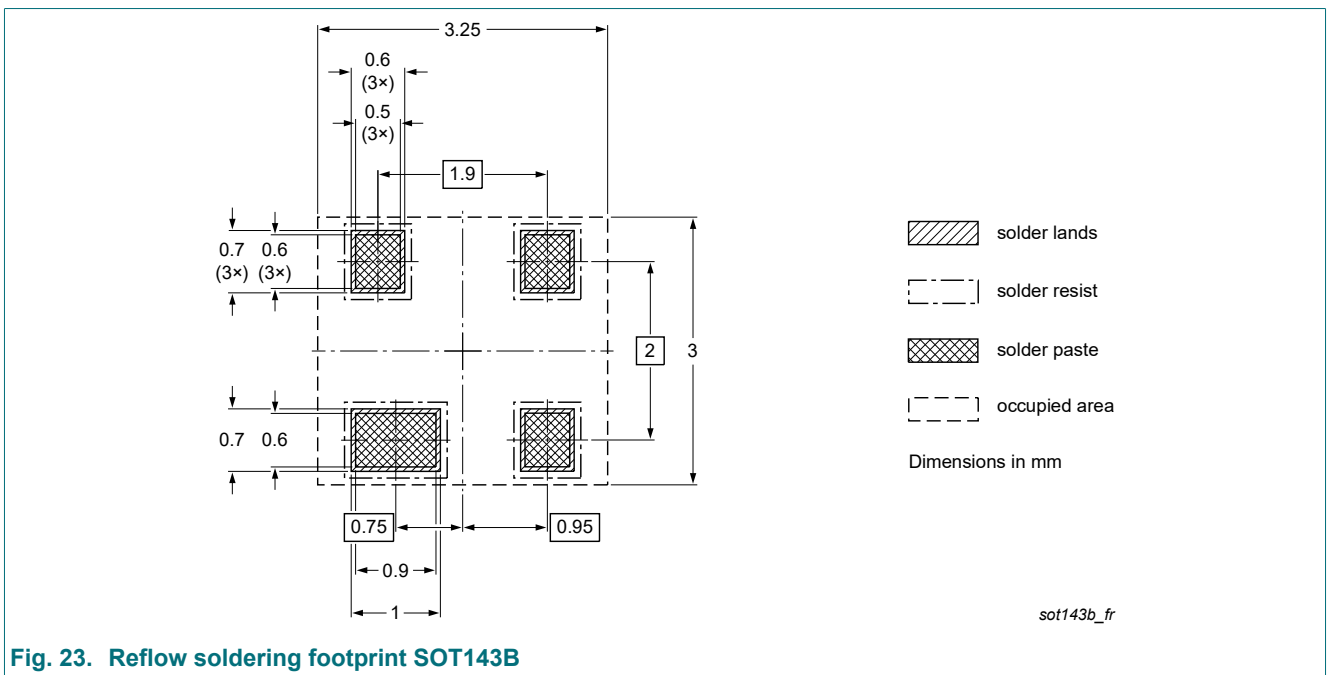

Fig. 23. Reflow soldering footprint SOT143B

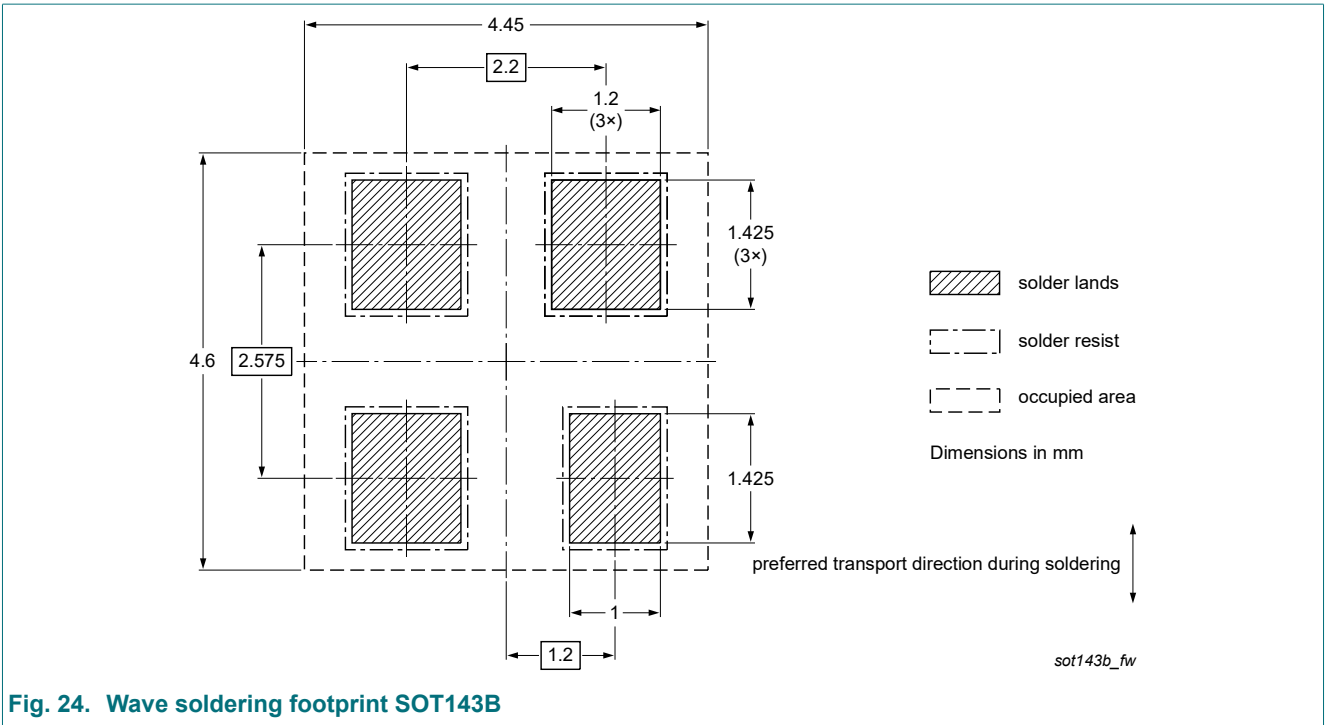

Fig. 24. Wave soldering footprint SOT143B

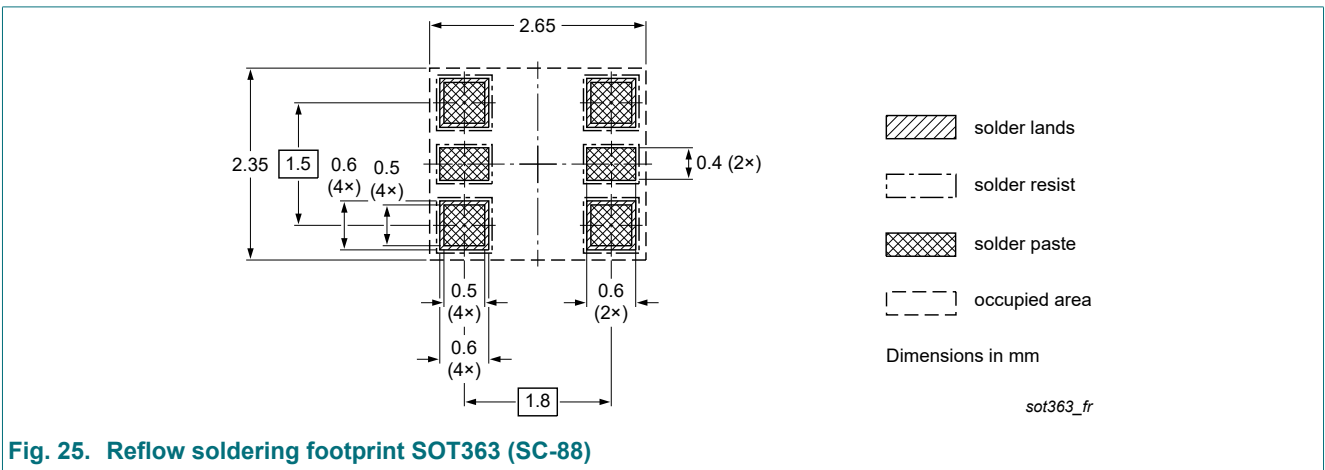

Fig. 25. Reflow soldering footprint SOT363 (SC-88)

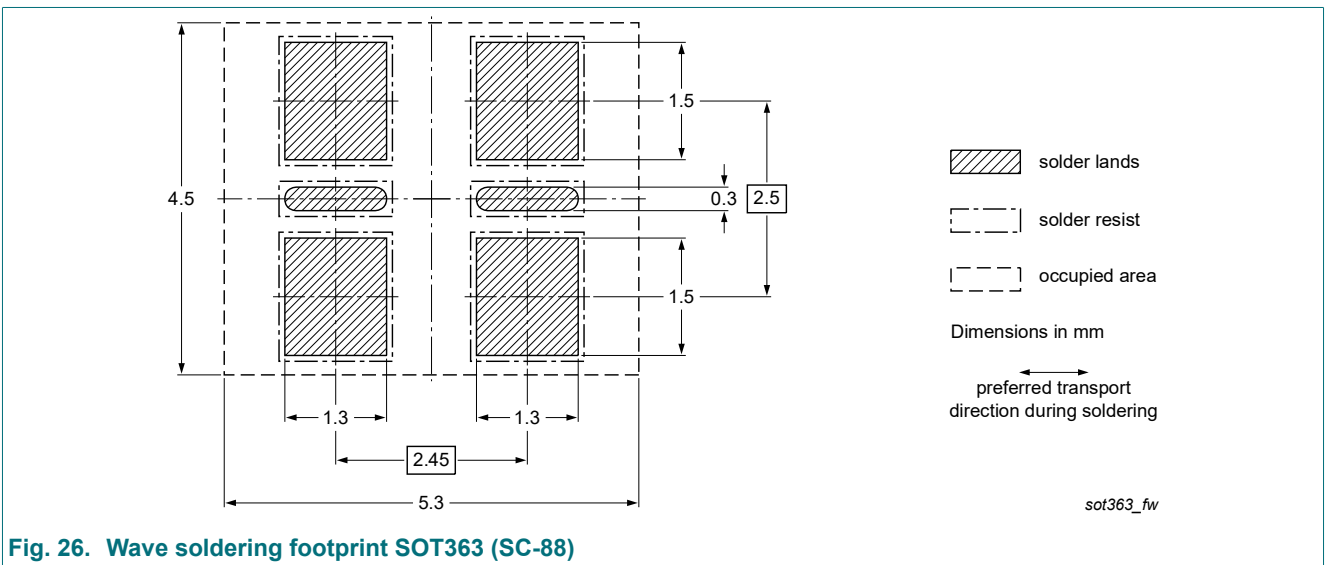

Fig. 26. Wave soldering footprint SOT363 (SC-88)

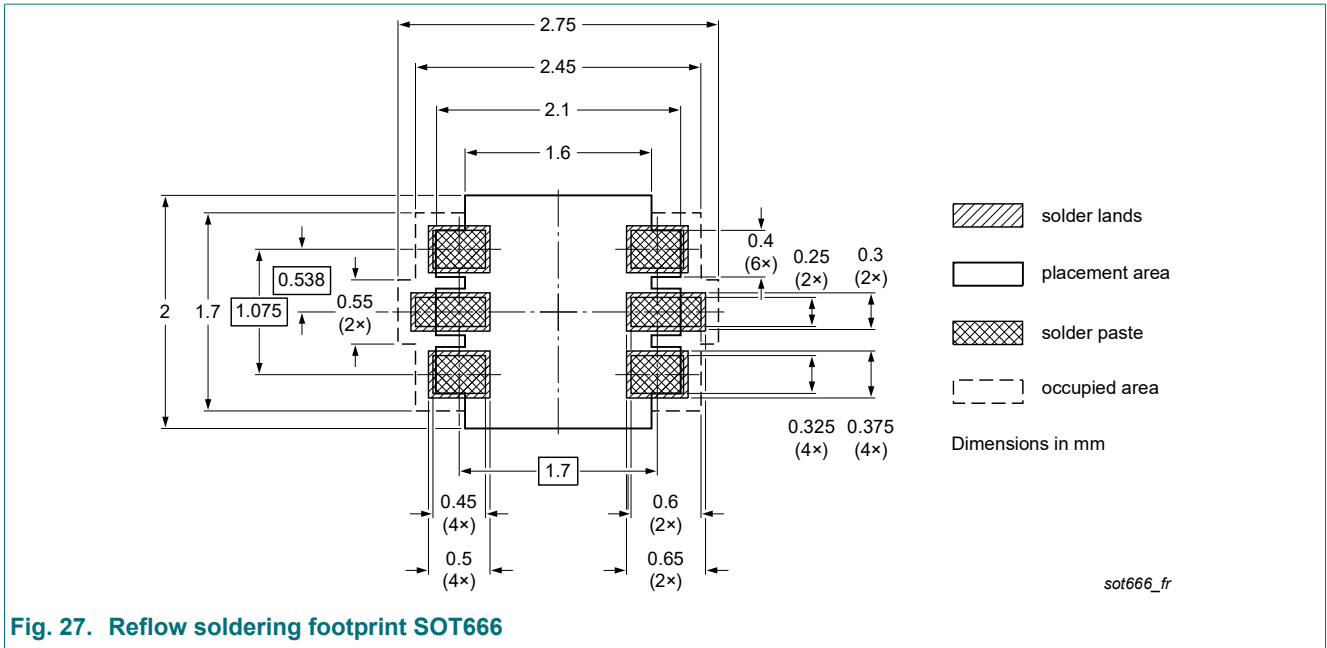

Fig. 27. Reflow soldering footprint SOT666

11. Revision history

Table 10. Revision history

Document ID	Release date	Data sheet status	Change notice	Supersedes
BAS70_1PS7XSB70_SER v.10	20210407	Product data sheet	-	BAS70_1PS7XSB70_SER_9
Modifications:	<ul style="list-style-type: none"> Soldering: Reflow soldering footprint SOD523 (SC-76) was updated. The format of this data sheet has been redesigned to comply with the new identity guidelines of Nexperia. Legal texts have been adapted to the new company name where appropriate. 			
BAS70_1PS7XSB70_SER_9	20060504	Product data sheet	-	BAS70_1PS7XSB70_SER_8
BAS70_1PS7XSB70_SER_8	20060504	Product data sheet	-	BAS70_1PS7XSB70_SER_7
BAS70_1PS7XSB70_SER_7	20050718	Product data sheet	-	1PS76SB70_2 1PS79SB70_1 BAS70H_1 BAS70L_1 BAS70-07V_1 BAS70VV BAS70W_3 BAS70-07S_4 BAS70_SERIES_6
1PS76SB70_2	20040126	Product specification	-	1PS76SB70_SER_1
1PS76SB70_1	19980716	Product specification	-	-
BAS70H_1	20050425	Product data sheet	-	-
BAS70L_1	20030520	Product specification	-	-
BAS70-07V_1	20020117	Product specification	-	-
BAS70VV_1	20040910	Product data sheet	-	-
BAS70W_3	19990326	Product data sheet	-	BAS70W_2
BAS70-07S_4	20030411	Product specification	-	BAS70_07S_3
BAS70_SERIES_6	20011011	Product specification	-	BAS70_5

12. Legal information

Data sheet status

Document status [1][2]	Product status [3]	Definition
Objective [short] data sheet	Development	This document contains data from the objective specification for product development.
Preliminary [short] data sheet	Qualification	This document contains data from the preliminary specification.
Product [short] data sheet	Production	This document contains the product specification.

- [1] Please consult the most recently issued document before initiating or completing a design.
- [2] The term 'short data sheet' is explained in section "Definitions".
- [3] The product status of device(s) described in this document may have changed since this document was published and may differ in case of multiple devices. The latest product status information is available on the internet at <https://www.nexperia.com>.

Definitions

Draft — The document is a draft version only. The content is still under internal review and subject to formal approval, which may result in modifications or additions. Nexperia does not give any representations or warranties as to the accuracy or completeness of information included herein and shall have no liability for the consequences of use of such information.

Short data sheet — A short data sheet is an extract from a full data sheet with the same product type number(s) and title. A short data sheet is intended for quick reference only and should not be relied upon to contain detailed and full information. For detailed and full information see the relevant full data sheet, which is available on request via the local Nexperia sales office. In case of any inconsistency or conflict with the short data sheet, the full data sheet shall prevail.

Product specification — The information and data provided in a Product data sheet shall define the specification of the product as agreed between Nexperia and its customer, unless Nexperia and customer have explicitly agreed otherwise in writing. In no event however, shall an agreement be valid in which the Nexperia product is deemed to offer functions and qualities beyond those described in the Product data sheet.

Disclaimers

Limited warranty and liability — Information in this document is believed to be accurate and reliable. However, Nexperia does not give any representations or warranties, expressed or implied, as to the accuracy or completeness of such information and shall have no liability for the consequences of use of such information. Nexperia takes no responsibility for the content in this document if provided by an information source outside of Nexperia.

In no event shall Nexperia be liable for any indirect, incidental, punitive, special or consequential damages (including - without limitation - lost profits, lost savings, business interruption, costs related to the removal or replacement of any products or rework charges) whether or not such damages are based on tort (including negligence), warranty, breach of contract or any other legal theory.

Notwithstanding any damages that customer might incur for any reason whatsoever, Nexperia's aggregate and cumulative liability towards customer for the products described herein shall be limited in accordance with the Terms and conditions of commercial sale of Nexperia.

Right to make changes — Nexperia reserves the right to make changes to information published in this document, including without limitation specifications and product descriptions, at any time and without notice. This document supersedes and replaces all information supplied prior to the publication hereof.

Suitability for use in automotive applications — This Nexperia product has been qualified for use in automotive applications. Unless otherwise agreed in writing, the product is not designed, authorized or warranted to be suitable for use in life support, life-critical or safety-critical systems or

equipment, nor in applications where failure or malfunction of an Nexperia product can reasonably be expected to result in personal injury, death or severe property or environmental damage. Nexperia and its suppliers accept no liability for inclusion and/or use of Nexperia products in such equipment or applications and therefore such inclusion and/or use is at the customer's own risk.

Quick reference data — The Quick reference data is an extract of the product data given in the Limiting values and Characteristics sections of this document, and as such is not complete, exhaustive or legally binding.

Applications — Applications that are described herein for any of these products are for illustrative purposes only. Nexperia makes no representation or warranty that such applications will be suitable for the specified use without further testing or modification.

Customers are responsible for the design and operation of their applications and products using Nexperia products, and Nexperia accepts no liability for any assistance with applications or customer product design. It is customer's sole responsibility to determine whether the Nexperia product is suitable and fit for the customer's applications and products planned, as well as for the planned application and use of customer's third party customer(s). Customers should provide appropriate design and operating safeguards to minimize the risks associated with their applications and products.

Nexperia does not accept any liability related to any default, damage, costs or problem which is based on any weakness or default in the customer's applications or products, or the application or use by customer's third party customer(s). Customer is responsible for doing all necessary testing for the customer's applications and products using Nexperia products in order to avoid a default of the applications and the products or of the application or use by customer's third party customer(s). Nexperia does not accept any liability in this respect.

Limiting values — Stress above one or more limiting values (as defined in the Absolute Maximum Ratings System of IEC 60134) will cause permanent damage to the device. Limiting values are stress ratings only and (proper) operation of the device at these or any other conditions above those given in the Recommended operating conditions section (if present) or the Characteristics sections of this document is not warranted. Constant or repeated exposure to limiting values will permanently and irreversibly affect the quality and reliability of the device.

Terms and conditions of commercial sale — Nexperia products are sold subject to the general terms and conditions of commercial sale, as published at <http://www.nexperia.com/profile/terms>, unless otherwise agreed in a valid written individual agreement. In case an individual agreement is concluded only the terms and conditions of the respective agreement shall apply. Nexperia hereby expressly objects to applying the customer's general terms and conditions with regard to the purchase of Nexperia products by customer.

No offer to sell or license — Nothing in this document may be interpreted or construed as an offer to sell products that is open for acceptance or the grant, conveyance or implication of any license under any copyrights, patents or other industrial or intellectual property rights.

Export control — This document as well as the item(s) described herein may be subject to export control regulations. Export might require a prior authorization from competent authorities.

Translations — A non-English (translated) version of a document is for reference only. The English version shall prevail in case of any discrepancy between the translated and English versions.

Trademarks

Notice: All referenced brands, product names, service names and trademarks are the property of their respective owners.

Contents

1. Product profile	1
1.1. General description.....	1
1.2. Features and benefits.....	2
1.3. Applications.....	2
1.4. Quick reference data.....	2
2. Pinning information	3
3. Ordering information	5
4. Marking	6
5. Limiting values	6
6. Thermal characteristics	7
7. Characteristics	7
8. Test information	8
8.1. Quality information.....	8
9. Package outline	9
10. Soldering	11
11. Revision history	17
12. Legal information	18

© Nexperia B.V. 2021. All rights reserved

For more information, please visit: <http://www.nexperia.com>
For sales office addresses, please send an email to: salesaddresses@nexperia.com
Date of release: 7 April 2021
