

# CAS5140

## Single Channel 256 Tap Digital Potentiometer (POT) with Integrated EEPROM and I<sup>2</sup>C Control

The CAS5140 is a single channel non-volatile 256-tap digital POT. This digital POT is comprised of a series of equal value resistor elements connected between two externally accessible end points. The tap points between each resistive element can be selectively connected to the wiper output via internal CMOS switches forming a linear taper electronic potentiometer.

The CAS5140 contains a volatile wiper register (WR) and an 8-bit non-volatile EEPROM for wiper position and 5 additional non-volatile registers for general purpose data storage. Programming of the registers is controlled via I<sup>2</sup>C interface. On power up, the wiper position is reset to the most recent value stored in the non-volatile memory register (IVR).

The CAS5140 is available in an Pb free, RoHS compliant 8-lead MSOP package, and operates over the industrial temperature range of -40°C to +85°C.

### Features

- 400 kHz I<sup>2</sup>C Compatible Interface
- 256 Position Linear Taper Potentiometer
- End-to-End Resistance = 50 kΩ / 100 kΩ
- TCR = 100 ppm/°C (typical)
- Standby Current = 2 μA (max)
- Typical Wiper Resistance = 70 Ω @ 3.3 V
- Operating Voltage = 2.5 V to 5.5 V
- 6 Registers 8-bit Non-volatile EEPROM
- 2,000,000 Data Write Stores
- 100 Year Data Retention
- 8-lead MSOP Package
- NiPdAu Plating
- These Devices are Pb-Free and are RoHS Compliant

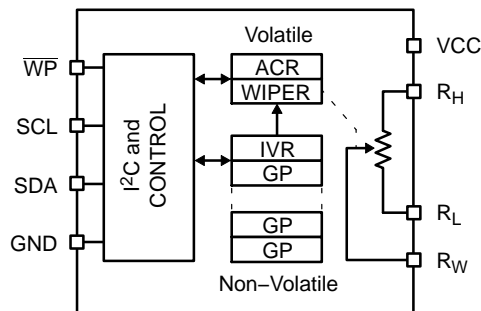
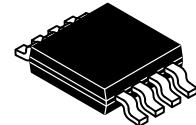

Figure 1. Functional Block Diagram



ON Semiconductor®

[www.onsemi.com](http://www.onsemi.com)



MSOP-8 3x3  
Z SUFFIX  
CASE 846AD

### MARKING DIAGRAM

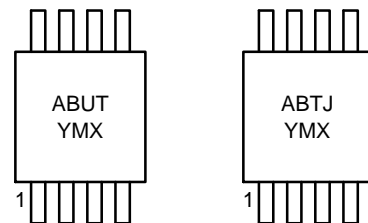

ABUT = 100 kΩ Resistance  
ABTJ = 50 kΩ Resistance  
Y = Production Year  
(Last Digit)  
M = Production Month  
(1 - 9, A, B, C)  
X = Production Revision

### PIN CONNECTIONS

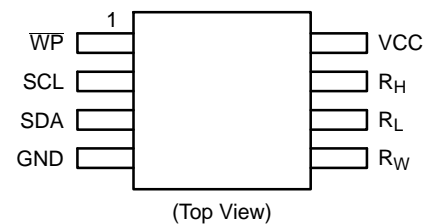

### ORDERING INFORMATION

See detailed ordering and shipping information in the package dimensions section on page 2 of this data sheet.

# CAS5140

**Table 1. ORDERING INFORMATION**

Part Number	Resistance	Temperature Range	Package	Shipping†
CAS5140ZI-50-GT3	50 kΩ	-40°C to 85°C	MSOP-8 3x3 (Pb-Free)	3000/Tape & Reel
CAS5140ZI-00-GT3	100 kΩ			3000/Tape & Reel

†For information on tape and reel specifications, including part orientation and tape sizes, please refer to our Tape and Reel Packaging Specifications Brochure, BRD8011/D.

1. For detailed information and a breakdown of device nomenclature and numbering systems, please see the ON Semiconductor Device Nomenclature document, TND310/D, available at [www.onsemi.com](http://www.onsemi.com).

**Table 2. PIN FUNCTION DESCRIPTION**

Pin No.	Pin Name	Description
1	WP	Memory Write Protect: Active Low
2	SCL	Serial Clock
3	SDA	Serial Data
4	GND	Ground
5	R <sub>W</sub>	Wiper Terminal
6	R <sub>L</sub>	Potentiometer Low Terminal
7	R <sub>H</sub>	Potentiometer High Terminal
8	V <sub>CC</sub>	Supply Voltage

**WP: Write Protect Input**

The  $\overline{WP}$  pin when tied low prevents any write operations within the device.

**SCL: Serial Clock**

The CAS5140 serial clock input pin is used to clock all data transfers into or out of the device.

**SDA: Serial Data**

The CAS5140 bidirectional serial data pin is used to transfer data into and out of the device. The SDA pin is an

open drain output and can be wire-ORed with the other open drain or open collector I/Os.

**R<sub>H</sub>, R<sub>L</sub>: Resistor End Points**

The set of R<sub>H</sub> and R<sub>L</sub> pins is equivalent to the terminal connections on a mechanical potentiometer.

**R<sub>W</sub>: Wiper**

The R<sub>W</sub> pin is equivalent to the wiper terminal of a mechanical potentiometer and its position is controlled by the WR register.

**Table 3. ABSOLUTE MAXIMUM RATINGS**

Parameter	Rating	Unit
V <sub>IN</sub> Supply Voltage V <sub>CC</sub> to Ground (Note 2)	-0.5 to +7	V
Terminal voltages: R <sub>H</sub> , R <sub>L</sub> , R <sub>W</sub> , SDA, SCL, $\overline{WP}$	-0.5 to V <sub>CC</sub> + 0.5	V
Wiper Current	±6.0	mA
Storage Temperature Range	-65 to +150	°C
Junction Temperature Range	-40 to +150	°C
Lead Soldering Temperature (10 seconds)	300	°C
ESD Rating HBM (Human Body Model)	2000	V
ESD Rating MM (Machine Model)	200	V

Stresses exceeding those listed in the Maximum Ratings table may damage the device. If any of these limits are exceeded, device functionality should not be assumed, damage may occur and reliability may be affected.

2. The minimum DC input voltage is -0.5 V. During transitions, inputs may undershoot to -2.0 V for periods of less than 20 ns. Maximum DC voltage on output pins is V<sub>CC</sub> + 0.5 V, which may overshoot to V<sub>CC</sub> + 2.0 V for periods of less than 20 ns.

**Table 4. RECOMMENDED OPERATING CONDITIONS**

Parameter	Rating	Unit
V <sub>CC</sub>	2.5 to 5.5	V
Wiper Current	±3	mA
Temperature Range	-40 to +85	°C

Functional operation above the stresses listed in the Recommended Operating Ranges is not implied. Extended exposure to stresses beyond the Recommended Operating Ranges limits may affect device reliability.

# CAS5140

**Table 5. POTENTIOMETER CHARACTERISTICS** (Note 3) ( $V_{CC} = +2.5\text{ V to }+5.5\text{ V}$ ,  $-40^{\circ}\text{C to }+85^{\circ}\text{C}$  unless otherwise specified.)

Parameter	Test Conditions	Symbol	Limits			Units
			Min	Typ	Max	
Potentiometer Resistance '-50'		$R_{POT}$		50		$k\Omega$
Potentiometer Resistance '-00'		$R_{POT}$		100		$k\Omega$
Potentiometer Resistance Tolerance					$\pm 20$	%
Power Rating	$25^{\circ}\text{C}$				50	mW
Wiper Current		$I_W$			$\pm 3$	mA
Wiper Resistance	$I_W = \pm 3\text{ mA}$ $V_{CC} = 3.3\text{ V}$	$R_W$		70	200	$\Omega$
Integral Non-Linearity	Voltage Divider Mode	INL			$\pm 1.5$	LSB (Note 4)
Differential Non-Linearity		DNL			$\pm 1.5$	LSB (Note 4)
Integral Non-Linearity	Resistor Mode	RINL			$\pm 1.5$	LSB (Note 4)
Differential Non-Linearity		RDNL			$\pm 1.5$	LSB (Note 4)
Voltage on $R_H$ or $R_L$	$V_{SS} = 0\text{ V}$	$V_{TERM}$	$V_{SS}$		$V_{CC}$	V
Resolution				0.4		%
Zero Scale Error			0	0.5	2	LSB (Note 5)
Full Scale Error			-2	-0.5	0	LSB (Note 5)
Temperature Coefficient of $R_{POT}$	(Notes 6, 7)	$TC_{R_{POT}}$		$\pm 100$		ppm/ $^{\circ}\text{C}$
Ratiometric Temp. Coefficient	(Notes 6, 7)	$TC_{RATIO}$			20	ppm/ $^{\circ}\text{C}$
Potentiometer Capacitances	(Notes 6, 7)	$C_H/C_L/C_W$		10/10/25		pF
Frequency Response	$R_{POT} = 50\text{ k}\Omega$ (Note 8)	fc		0.4		MHz

3. Latch-up protection is provided for stresses up to 100 mA on address and data pins from  $-1\text{ V to }V_{CC} + 1\text{ V}$ .

4. LSB =  $R_{TOT} / 255$  or  $(R_H - R_L) / 255$ , single pot. For mid-scale detail, please refer to corresponding graphs shown in Figures 2, 3, 4, and 5.

5.  $V(R_W)_{255} - V(R_W)_0 / 255$  ( $R_W)_{255} = 0x\text{FF}$ , ( $R_W)_0 = 0x00$ ).

6. Absolute linearity is utilized to determine actual wiper voltage versus expected voltage as determined by wiper position when used as a potentiometer.

7. Relative linearity is a measure of the error in step size. It is determined by the actual change in voltage between two successive tap positions when used as a potentiometer.

8. This parameter is tested initially and after a design or process change that affects the parameter.

**Table 6. D.C. OPERATING CHARACTERISTICS** ( $V_{CC} = +2.5\text{ V to }+5.5\text{ V}$ ,  $-40^{\circ}\text{C to }+85^{\circ}\text{C}$  unless otherwise specified.)

Parameter	Test Conditions	Symbol	Min	Max	Units
Power Supply Current Volatile Write & Read	$f_{SCL} = 400\text{ kHz}$ $V_{CC} = 5.5\text{ V}$ , Inputs = GND	$I_{CC1}$		1	mA
Power Supply Current Non-volatile Write	$f_{SCL} = 400\text{ kHz}$ $V_{CC} = 5.5\text{ V}$ , Inputs = GND	$I_{CC2}$		3	mA
Standby Current	$V_{CC} = 5.0\text{ V}$	$I_{SB}$		2	$\mu\text{A}$
Input Leakage Current	$V_{IN} = \text{GND to }V_{CC}$	$I_{LI}$	-10	+10	$\mu\text{A}$
Output Leakage Current	$V_{OUT} = \text{GND to }V_{CC}$	$I_{LO}$		10	$\mu\text{A}$
Input Low Voltage		$V_{IL}$	-1	$V_{CC} \times 0.3$	V
Input High Voltage		$V_{IH}$	$V_{CC} \times 0.7$	$V_{CC} + 1.0$	V
SDA Output Buffer Low Voltage	$V_{CC} = 2.5\text{ V}$ , $I_{OL} = 4\text{ mA}$	$V_{OL1}$		0.4	V
Power-On Recall	Minimum $V_{CC}$ for memory recall	$V_{POR}$	1.4	2.0	V

Product parametric performance is indicated in the Electrical Characteristics for the listed test conditions, unless otherwise noted. Product performance may not be indicated by the Electrical Characteristics if operated under different conditions.

# CAS5140

**Table 7. CAPACITANCE** ( $T_A = 25^\circ\text{C}$ ,  $f = 1.0\text{ MHz}$ ,  $V_{CC} = 5\text{ V}$ )

Test	Test Conditions	Symbol	Max	Units
Input/Output Capacitance (SDA)	$V_{I/O} = 0\text{ V}$	$C_{I/O}$ (Note 9)	8	pF
Input Capacitance (SCL, WP)	$V_{IN} = 0\text{ V}$	$C_{IN}$ (Note 9)	6	pF

**Table 8. POWER UP TIMING** (Notes 9 and 10)

Parameter	Symbol	Max	Units
Power-up to Read Operation	$t_{PUR}$	1	ms
Power-up to Write Operation	$t_{PUW}$	1	ms

9. This parameter is tested initially and after a design or process change that affects the parameter.

10.  $t_{PUR}$  and  $t_{PUW}$  are delays required from the time  $V_{CC}$  is stable until the specified operation can be initiated.

**Table 9. DIGITAL POT TIMING**

Parameter	Symbol	Min	Max	Units
Wiper Response Time After Power Supply Stable	$t_{WRPO}$		50	$\mu\text{s}$
Wiper Response Time: SCL falling edge after last bit of wiper position data byte to wiper change	$t_{WR}$		20	$\mu\text{s}$

**Table 10. ENDURANCE**

Parameter	Reference Test Method	Symbol	Min	Max	Units
Endurance	MIL-STD-883, Test Method 1033	$N_{END}$	2,000,000		Cycles
Data Retention	MIL-STD-883, Test Method 1008	$T_{DR}$	100		Years

**Table 11. A.C. CHARACTERISTICS** ( $V_{CC} = +2.5\text{ V}$  to  $+5.5\text{ V}$ ,  $-40^\circ\text{C}$  to  $+85^\circ\text{C}$  unless otherwise specified.)

Parameter	Symbol	Min	Typ	Max	Units
Clock Frequency	$f_{SCL}$			400	kHz
Clock High Period	$t_{HIGH}$	600			ns
Clock Low Period	$t_{LOW}$	1300			ns
Start Condition Setup Time (for a Repeated Start Condition)	$t_{SU:STA}$	600			ns
Start Condition Hold Time	$t_{HD:STA}$	600			ns
Data in Setup Time	$t_{SU:DAT}$	100			ns
Data in Hold Time	$t_{HD:DAT}$	0			ns
Stop Condition Setup Time	$t_{SU:STO}$	600			ns
Time the bus must be free before a new transmission can start	$t_{BUF}$	1300			ns
WP Setup Time	$t_{SU:WP}$	0			$\mu\text{s}$
WP Hold Time	$t_{HD:WP}$	2.5			$\mu\text{s}$
SDA and SCL Rise Time	$t_R$			300	ns
SDA and SCL Fall Time	$t_F$			300	ns
Data Out Hold Time	$t_{DH}$		100		ns
Noise Suppression Time Constant at SCL, SDA Inputs	$T_I$			50	ns
SLC Low to SDA Data Out and ACK Out	$t_{AA}$			1	$\mu\text{s}$
Non-Volatile Write Cycle Time	$t_{WR}$		4	10	ms

TYPICAL CHARACTERISTICS

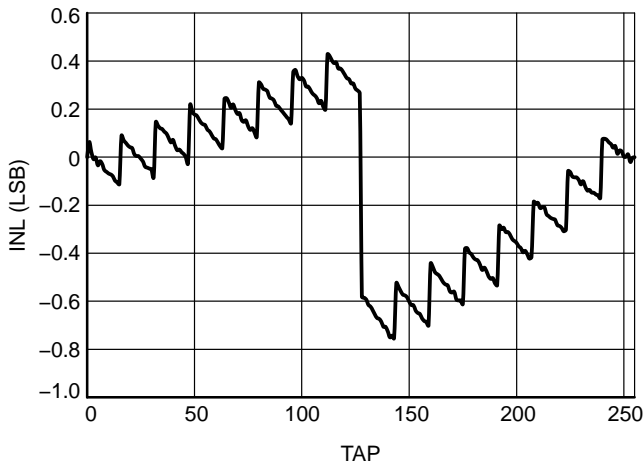

Figure 2. Average Integral Non-Linearity (V<sub>CC</sub> = 2.4 V) Voltage Divider Mode

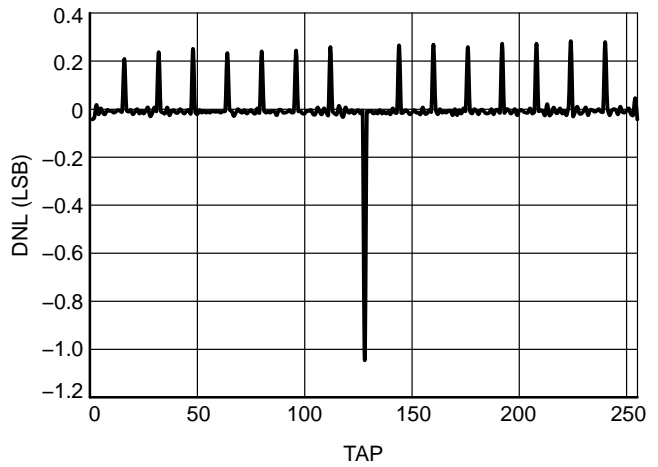

Figure 3. Average Differential Non-Linearity (V<sub>CC</sub> = 2.4 V) Voltage Divider Mode

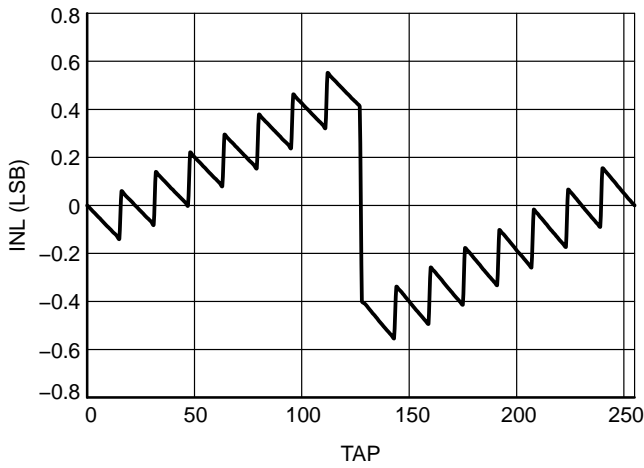

Figure 4. Average Integral Non-Linearity (V<sub>CC</sub> = 2.4 V) Resistor Mode

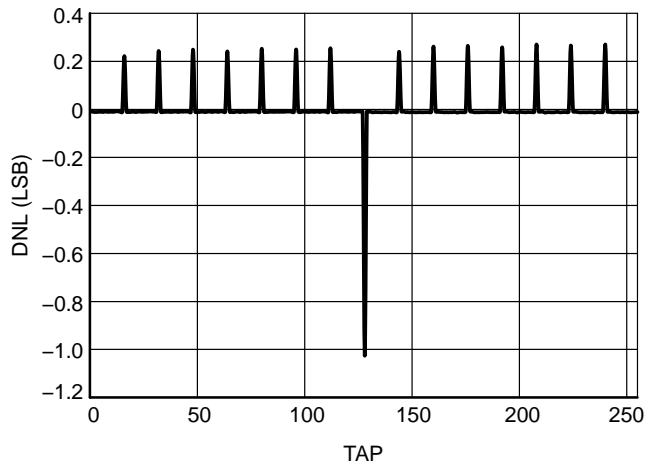

Figure 5. Average Differential Non-Linearity (V<sub>CC</sub> = 2.4 V) Resistor Mode

# CAS5140

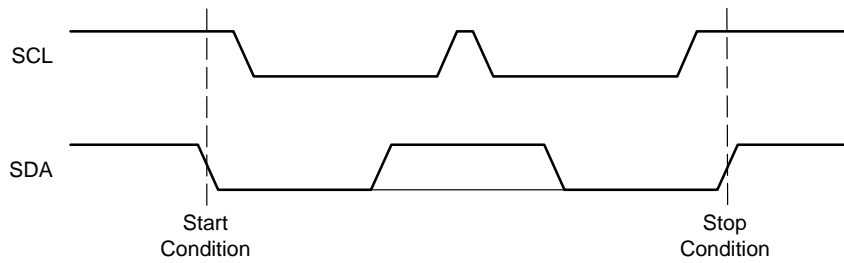

Figure 6. Start and STOP Timing

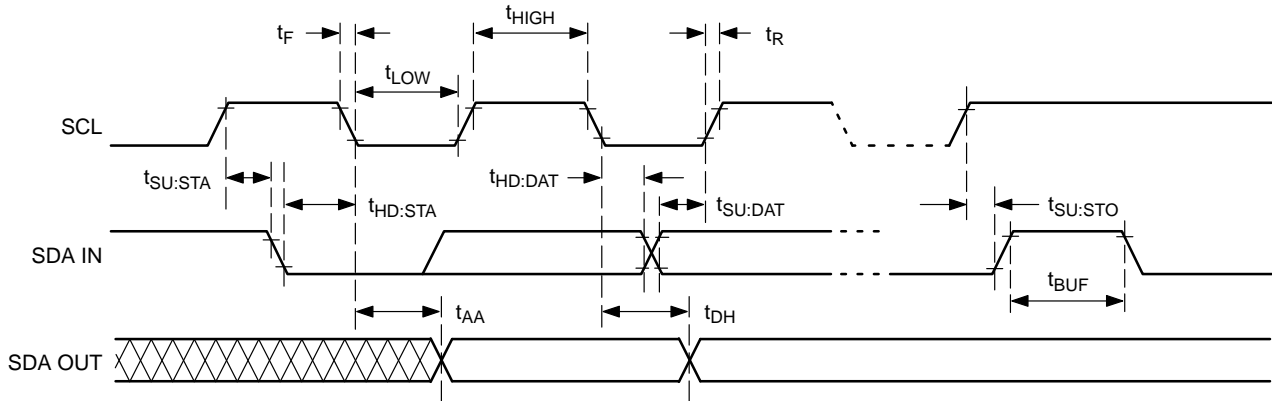

Figure 7. Bus Timing

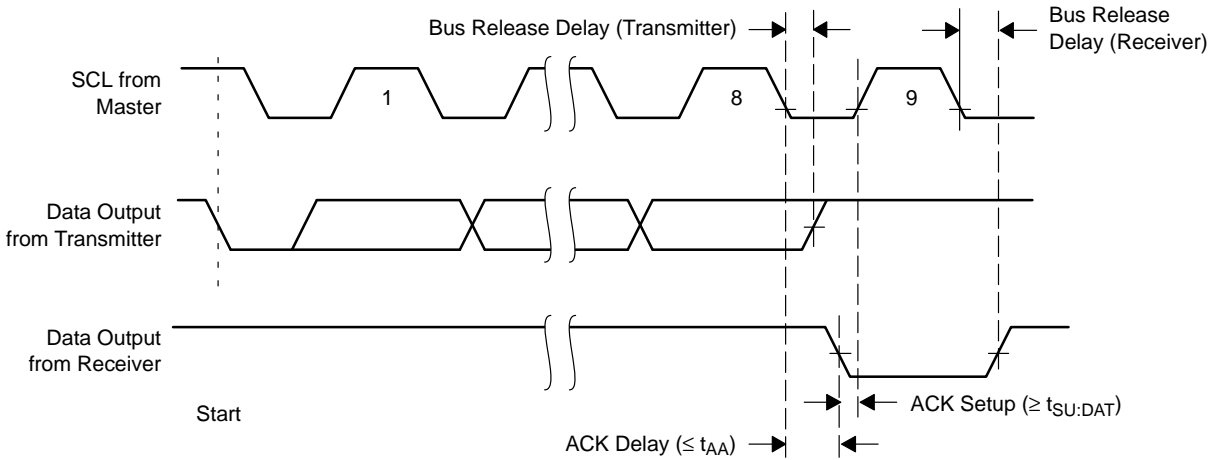

Figure 8. Acknowledge Timing

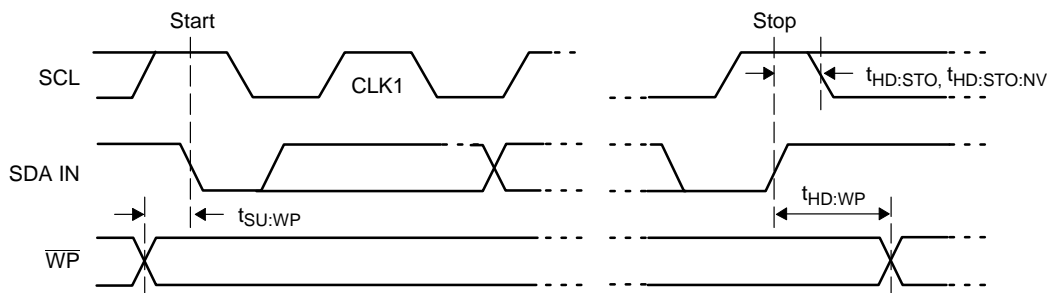
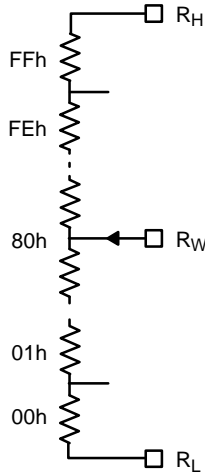

Figure 9.  $\overline{WP}$  Timing

**Device Operation**

The CAS5140 is a resistor array integrated with a I<sup>2</sup>C serial interface logic, an 8-bit volatile wiper register, and six 8-bit, non-volatile memory data registers. The resistor array contains 255 separate resistive elements connected in series. The physical ends of the array are equivalent to the fixed terminals of a mechanical potentiometer (R<sub>H</sub> and R<sub>L</sub>). The tap positions between and at the ends of the series resistors are connected to the output wiper terminal (R<sub>W</sub>) by CMOS transistor switches. Only one tap point for the potentiometer is connected to the wiper terminal at a time and is determined by the value of an 8-bit Wiper Register (WR).



When power is first applied to CAS5140 the wiper is set to midscale; Wiper Register = 80h. When the power supply becomes sufficient to read the non-volatile memory the value stored in the Initial Value Register (IVR) is transferred into the Wiper Register and the wiper moves to this new position. Five additional 8-bit non-volatile memory data registers are provided for general purpose data storage. Data can be read or written to the volatile or the non-volatile memory data registers via the I<sup>2</sup>C bus.

**Serial Bus Protocol**

The following defines the features of the 2-wire bus protocol:

1. Data transfer may be initiated only when the bus is not busy.
2. During a data transfer, the data line must remain stable whenever the clock line is high. Any changes in the data line while the clock is high will be interpreted as a START or STOP condition.

The device controlling the transfer is a master, typically a processor or controller, and the device being controlled is the slave. The master will always initiate data transfers and provide the clock for both transmit and receive operations. Therefore, the CAS5140 will be considered a slave device in all applications.

**START Condition**

The START condition precedes all commands to the device, and is defined as a HIGH to LOW transition of SDA when SCL is HIGH. The CAS5140 monitors the SDA and SCL lines and will not respond until this condition is met.

**STOP Condition**

A LOW to HIGH transition of SDA when SCL is HIGH determines the STOP condition. All operations must end with a STOP condition.

**Device Addressing**

The bus Master begins a transmission by sending a START condition. The Master then sends the address of the particular slave device it is requesting. CAS5140 has a fixed 7 bit slave address: 0101000. The 8<sup>th</sup> bit (LSB) is the Read/Write instruction bit. For a Read the value is “1” and for Write the value is “0”.

After the Master sends a START condition and the slave address byte, the CAS5140 monitors the bus and responds with an acknowledge (on the SDA line) when its address matches the transmitted slave address.

**Table 12. SALVE ADDRESS BIT FORMAT**

MSB						LSB	
0	1	0	1	0	0	0	R/W

**Acknowledge (ACK)**

After a successful data transfer, each receiving device is required to generate an acknowledge. The Acknowledging device pulls down the SDA line during the ninth clock cycle, signaling that it received the 8 bits of data.

CAS5140 responds with an acknowledge after receiving a START condition and its slave address. If the device has been selected along with a write operation, it responds with an acknowledge after receiving each 8-bit byte. When the CAS5140 is in a READ mode it transmits 8 bits of data, releases the SDA line, and monitors the line for an acknowledge. Once it receives this acknowledge, the CAS5140 will continue to transmit data. If no acknowledge is sent by the Master, the device terminates data transmission and waits for a STOP condition.

**WRITE Operation**

In the Write mode, the Master device sends the START condition and the slave address information to the Slave device. In CAS5140’s case the slave address also contains a Read/Write command (R/W) on the last bit of the 1st byte. After receiving an acknowledge from the Slave, the Master device transmits a second byte containing a Memory Address to select an available register. After a second acknowledge is received from the Slave, the Master device sends the data to be written into the selected register. The

# CAS5140

CAS5140 acknowledges once more and the Master generates the STOP condition, at which time if a nonvolatile data register is being selected, the device begins an internal programming cycle to non-volatile memory. If the STOP condition is not sent immediately after the last ACK the internal non-volatile programming cycle doesn't start. While this internal cycle is in progress, the device will not respond to any request from the Master device.

Write operations to volatile memory are completed during the last bit of the data byte before the slave's acknowledge. The device will be ready for another command only after a STOP condition sent by Master.

## Acknowledge Polling

The disabling of the inputs can be used to take advantage of the typical write cycle time. Once the stop condition is issued to indicate the end of the host's write operation, the CAS5140 initiates the internal write cycle. ACK polling can be initiated immediately. This involves issuing the start condition followed by the slave address. If the CAS5140 is still busy with the write operation, no ACK will be returned. If the CAS5140 has completed the write operation, an acknowledge will be returned and the host can then proceed with the next instruction operation.

## WRITE Protection

The Write Protection feature allows the user to protect against inadvertent programming of the non-volatile data registers. If the  $\overline{WP}$  pin is tied to LOW, the data registers are protected and become read only. Similarly, the  $\overline{WP}$  pin going low after start will interrupt a nonvolatile write to data registers, while the  $\overline{WP}$  pin going low after an internal write cycle has started will have no effect on any write operation. CAS5140 will accept slave addresses but the data registers are protected from programming, which the device indicates by failing to send an acknowledge after data is received.

## Address 8: Volatile Access Control Register – ACR (I/O)

The ACR bit 7 (VOL) toggles between Non-volatile and volatile registers accessed at address 00h. When VOL is Low (0), the non-volatile IVR is accessed at address 00h. When VOL is high (1), the volatile Wiper Register is accessed at address 00h. The initial default value for VOL = 0.

Bit	7	6	5	4	3	2	1	0
Name	0/1 VOL	0	0	0	0	0	0	0

00h and 80h are the only values that should be written to address 08h. For any other value written to address 08h the slave will load only bit 7 but it will answer with a NoACK.

## Address 7: RESERVED

The user should not read or write to this address. CAS5140 will respond with NoACK and it will take no action. Address 07h can be accessed only in a sequential read and its content is FFh.

## Address 6–2: Non-volatile General Purpose Memory (I/O)

8-bit Non-volatile Memory

Bit	7	6	5	4	3	2	1	0
Name	-	-	-	-	-	-	-	-

General Purpose Memories are preprogrammed at the factory to a default value of "00h".

## READ Operation

A Read operation with a designated address consists of a three byte instruction followed by one or more Data Bytes (See Figure 7). The master initiates the operation issuing a START, an Identification byte with the  $R/\overline{W}$  bit set to "0", an Address Byte. Then the master sends a second START, and a second Identification byte with the  $R/\overline{W}$  bit set to "1". After each of the three bytes, the CAS5140 responds with an ACK. Then CAS5140 transmits the Data Byte. The master then can continue the read operation with the content of the next register by sending acknowledge or can terminate the read operation by issuing a NoACK followed by a STOP condition after the last bit of a Data Byte.

Table 13. MEMORY MAP

Address	Non-volatile		Volatile Register
	Register	Default Value	
8	ACR		
7	Reserved		
6	General Purpose	00h	N/A
5	General Purpose	00h	N/A
4	General Purpose	00h	N/A
3	General Purpose	00h	N/A
2	General Purpose	00h	N/A
1	Device ID (read only)	D0h	N/A
0	IVR	80h	WR

If the master sends address 07h or addresses greater than 08h the slave responds with NoACK after the Memory Address byte.



# CAS5140

## Address 1: Device ID (Read Only)

Bit 7 defines the Digital POT device manufacturer; Catalyst/On Semiconductor = high (1)

Bit	7	6	5	4	3	2	1	0
Name	1	1	0	1	0	0	0	0

A writing to address 1 has no effect. Attempts to do so will return an ACK but no data will be written.

## Address 0: IVR/WR Register (I/O)

Address 00h accesses one of two memory registers: the initial value register (IVR) or the wiper register (WR) depending upon the value of bit 7 in Access Control Register (ACR) which is at address 08h, above.

WR controls the wiper's position and is a volatile memory while IVR is non-volatile and retains its data after the chip has been powered down. Writes to IVR automatically update the WR while writes to WR leave IVR unaffected.

WR: Wiper Register = Volatile.

IVR: Initial Value Register = Non-volatile.

Writing and Reading operations:

- If Bit 7 from ACR is 0 (non-volatile):
  - ◆ A write operation to address 00h will write the same value in WR and IVR.
  - ◆ A read operation to address 00h will output the content of IVR.
- If bit 7 from ACR is 1 (volatile):
  - ◆ A write operation to address 00h will write in WR only.
  - ◆ A read operation to address 00h will output the content of WR.

All changes to the wiper's position are immediate. There is no delay the wiper's movement when writing to non-volatile memory.

Bit	7	6	5	4	3	2	1	0
Name	-	-	-	-	-	-	-	-

IVR is preprogrammed at the factory to a default value of "80h".

## I<sup>2</sup>C SERIAL BUS INSTRUCTION FORMAT

Table 14. I<sup>2</sup>C SLAVE ADDRESS BITS

	Transfer Data	Slave Address							R/W bit
		bit 7	bit 6	bit 5	bit 4	bit 3	bit 2	bit 1	bit 0
Read	51h	0	1	0	1	0	0	0	1 (R)
Write	50h								0 ( $\bar{W}$ )

If the Slave Address Byte sent by the host is different the device will send a NoACK.

## I<sup>2</sup>C Protocol:

### (A) Write data procedure with designated address. (See Table 15)

- Host transfers the start condition
- Host transfers the device slave address with the write mode R/ $\bar{W}$  bit (0).
- Device sends ACK
- Host transfers the corresponding memory address to the device
- Device sends ACK
- Host transfers the write data to the designated address
- Device sends ACK
- Routines (6) and (7) are repeated based on the transfer data, and the designated address is automatically incremented\*
- Host transfers the stop condition.

\*Automatically incremented writes are not possible after a non-volatile write.

## CAS5140

Single write to either a volatile or non-volatile register. Note that Bit 7 of ACR determines which memory type is being written.

**Table 15. SINGLE WRITE**

(1)	(2)		(3)	(4)	(5)	(6)	(7)	(9)
Start	Slave Address	0 R/ $\bar{W}$	0 ACK	Memory Address	0 ACK	Write Data	0 ACK	Stop

A single write to either a volatile or non-volatile register. At address 00h bit 7 of ACR determines which memory type is being written.

**Table 16. MULTIPLE WRITES**

(1)	(2)		(3)	(4)	(5)	(6)	(7)	(8)		(9)
Start	Slave Address	0 R/ $\bar{W}$	0 ACK	Memory Address	0 ACK	Write Data	0 ACK	Write Data	0 ACK	Stop

Multiple writes are possible only if the starting address is 08h and it should be stopped with the first nonvolatile data byte. If a nonvolatile write does not end with a STOP procedure the register is not written.

**(B) Read data procedure with designated address.**

1. Host transfers the start condition
2. Host transfers the device slave address with the write mode R/ $\bar{W}$  bit (0)
3. ACK signal recognition from the device
4. Host transfers the read address
5. ACK signal recognition from the device
6. Host transfers the re-start condition
7. Host transfers the slave address with the read mode R/ $\bar{W}$  bit (1).
8. ACK signal recognition from the device
9. The device transfers the read data from the designated address
10. Host transfers ACK signal
11. The (9) & (10) routines above are repeated if needed, and the read address is auto-incremented
12. Host transfers ACK 'H' to the device
13. Host transfers the stop condition

**Table 17. READ DATA**

(1)	(2)		(3)	(4)	(5)	(6)	(7)		(8)	(9)	(10)	(11)	(12)	(13)
Start	Slave Address	0 R/ $\bar{W}$	0 ACK	Memory Address	0 ACK	Restart	Slave Address	1 R/ $\bar{W}$	0 ACK	Read Data	0 ACK	Read Data	1 ACK	Stop

**(C) Read data procedure without a designated address.**

1. Host transfers the start condition
2. Host transfers the device slave address with the read mode R/ $\bar{W}$  bit =1
3. ACK signal recognition from the device. (Host then changes to receiver)
4. The device transfers data from the previous access address +1
5. Host transfers ACK signal
6. The (4) & (5) routines above are repeated if needed
7. Host transfers ACK 'H'
8. Host transfers the stop condition

**Table 18. Read Data w/o Designated Address**

(1)	(2)		(3)	(4)	(5)	(6)	(7)	(8)
Start	Slave Address	1 R/ $\bar{W}$	0 ACK	Read Data	0 ACK	Read Data	1 ACK	Stop

# CAS5140

## PACKAGE DIMENSIONS

MSOP 8, 3x3  
CASE 846AD  
ISSUE O

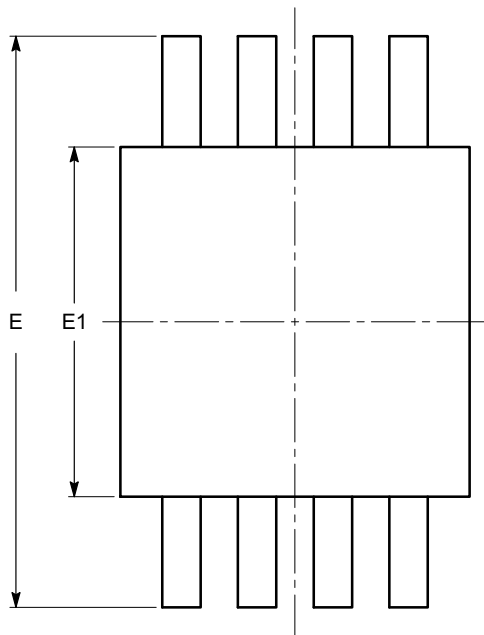

TOP VIEW

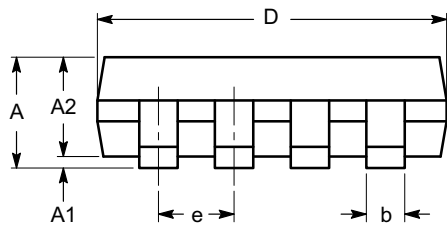

SIDE VIEW

SYMBOL	MIN	NOM	MAX
A			1.10
A1	0.05	0.10	0.15
A2	0.75	0.85	0.95
b	0.22		0.38
c	0.13		0.23
D	2.90	3.00	3.10
E	4.80	4.90	5.00
E1	2.90	3.00	3.10
e	0.65 BSC		
L	0.40	0.60	0.80
L1	0.95 REF		
L2	0.25 BSC		
$\theta$	0°		6°

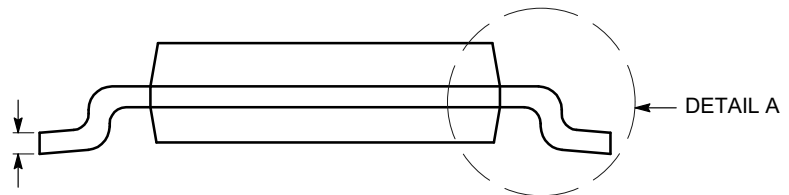

END VIEW

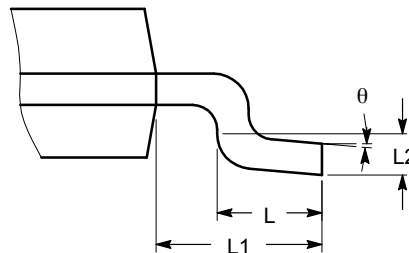

DETAIL A

**Notes:**

- (1) All dimensions are in millimeters. Angles in degrees.
- (2) Complies with JEDEC MO-187.

ON Semiconductor and the  are registered trademarks of Semiconductor Components Industries, LLC (SCILLC) or its subsidiaries in the United States and/or other countries. SCILLC owns the rights to a number of patents, trademarks, copyrights, trade secrets, and other intellectual property. A listing of SCILLC's product/patent coverage may be accessed at [www.onsemi.com/site/pdf/Patent-Marking.pdf](http://www.onsemi.com/site/pdf/Patent-Marking.pdf). SCILLC reserves the right to make changes without further notice to any products herein. SCILLC makes no warranty, representation or guarantee regarding the suitability of its products for any particular purpose, nor does SCILLC assume any liability arising out of the application or use of any product or circuit, and specifically disclaims any and all liability, including without limitation special, consequential or incidental damages. "Typical" parameters which may be provided in SCILLC data sheets and/or specifications can and do vary in different applications and actual performance may vary over time. All operating parameters, including "Typicals" must be validated for each customer application by customer's technical experts. SCILLC does not convey any license under its patent rights nor the rights of others. SCILLC products are not designed, intended, or authorized for use as components in systems intended for surgical implant into the body, or other applications intended to support or sustain life, or for any other application in which the failure of the SCILLC product could create a situation where personal injury or death may occur. Should Buyer purchase or use SCILLC products for any such unintended or unauthorized application, Buyer shall indemnify and hold SCILLC and its officers, employees, subsidiaries, affiliates, and distributors harmless against all claims, costs, damages, and expenses, and reasonable attorney fees arising out of, directly or indirectly, any claim of personal injury or death associated with such unintended or unauthorized use, even if such claim alleges that SCILLC was negligent regarding the design or manufacture of the part. SCILLC is an Equal Opportunity/Affirmative Action Employer. This literature is subject to all applicable copyright laws and is not for resale in any manner.

**PUBLICATION ORDERING INFORMATION**

**LITERATURE FULFILLMENT:**  
Literature Distribution Center for ON Semiconductor  
19521 E. 32nd Pkwy, Aurora, Colorado 80011 USA  
**Phone:** 303-675-2175 or 800-344-3860 Toll Free USA/Canada  
**Fax:** 303-675-2176 or 800-344-3867 Toll Free USA/Canada  
**Email:** [orderlit@onsemi.com](mailto:orderlit@onsemi.com)

**N. American Technical Support:** 800-282-9855 Toll Free  
USA/Canada  
**Europe, Middle East and Africa Technical Support:**  
Phone: 421 33 790 2910  
**Japan Customer Focus Center**  
Phone: 81-3-5817-1050

**ON Semiconductor Website:** [www.onsemi.com](http://www.onsemi.com)  
**Order Literature:** <http://www.onsemi.com/orderlit>  
For additional information, please contact your local Sales Representative