



# PESD5V0S1UA; PESD12VS1UA

Unidirectional ESD protection for transient voltage suppression

Rev. 01 — 9 February 2009

Product data sheet

## 1. Product profile

### 1.1 General description

Unidirectional ElectroStatic Discharge (ESD) protection diodes in a very small Surface-Mounted Device (SMD) plastic package designed to protect one signal line from the damage caused by ESD and transient overvoltage.

Table 1. Product overview

Type number	Package		Configuration
	Nexperia	JEITA	
PESD5V0S1UA	SOD323	SC-76	single
PESD12VS1UA			

### 1.2 Features

- Transient Voltage Suppression (TVS) protection of one line
- Max. peak pulse power:  $P_{PP} = 890 \text{ W}$
- Low clamping voltage:  $V_{CL} = 19 \text{ V}$
- Low leakage current:  $I_{RM} = 300 \text{ nA}$
- ESD protection up to 30 kV
- IEC 61000-4-2; level 4 (ESD)
- IEC 61000-4-5 (surge);  $I_{PP} = 47 \text{ A}$
- AEC-Q101 qualified

### 1.3 Applications

- Computers and peripherals
- Audio and video equipment
- Cellular handsets and accessories
- Communication systems
- Portable electronics
- Medical and industrial equipment

### 1.4 Quick reference data

Table 2. Quick reference data

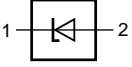
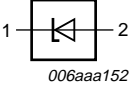
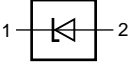
$T_{amb} = 25^\circ\text{C}$  unless otherwise specified.

Symbol	Parameter	Conditions	Min	Typ	Max	Unit
$V_{RWM}$	reverse standoff voltage					
	PESD5V0S1UA		-	-	5	V
	PESD12VS1UA		-	-	12	V
$C_d$	diode capacitance	$f = 1 \text{ MHz}; V_R = 0 \text{ V}$				
	PESD5V0S1UA		-	480	530	pF
	PESD12VS1UA		-	160	180	pF

nexperia

## 2. Pinning information

**Table 3. Pinning**

Pin	Description	Simplified outline	Graphic symbol
1	cathode	[1]	
2	anode		

[1] The marking bar indicates the cathode.

## 3. Ordering information

**Table 4. Ordering information**

Type number	Package		
	Name	Description	Version
PESD5V0S1UA	SC-76	plastic surface-mounted package; 2 leads	SOD323
PESD12VS1UA			

## 4. Marking

**Table 5. Marking codes**

Type number	Marking code
PESD5V0S1UA	AV
PESD12VS1UA	AW

## 5. Limiting values

**Table 6. Limiting values**

In accordance with the Absolute Maximum Rating System (IEC 60134).

Symbol	Parameter	Conditions	Min	Max	Unit
$P_{PP}$	peak pulse power	$t_p = 8/20 \mu s$	[1][2]		
	PESD5V0S1UA		-	890	W
	PESD12VS1UA		-	600	W
$I_{PP}$	peak pulse current	$t_p = 8/20 \mu s$	[1][2]		
	PESD5V0S1UA		-	47	A
	PESD12VS1UA		-	22.5	A

**Table 6. Limiting values ...continued***In accordance with the Absolute Maximum Rating System (IEC 60134).*

Symbol	Parameter	Conditions	Min	Max	Unit
P <sub>tot</sub>	total power dissipation	T <sub>amb</sub> ≤ 25 °C	[3] -	360	mW
			[4] -	500	mW
T <sub>j</sub>	junction temperature		-	150	°C
T <sub>amb</sub>	ambient temperature		-55	+150	°C
T <sub>stg</sub>	storage temperature		-65	+150	°C

[1] Non-repetitive current pulse 8/20 μs exponential decay waveform according to IEC 61000-4-5.

[2] Soldering point of cathode tab.

[3] Device mounted on an FR4 Printed-Circuit Board (PCB), single-sided copper, tin-plated and standard footprint.

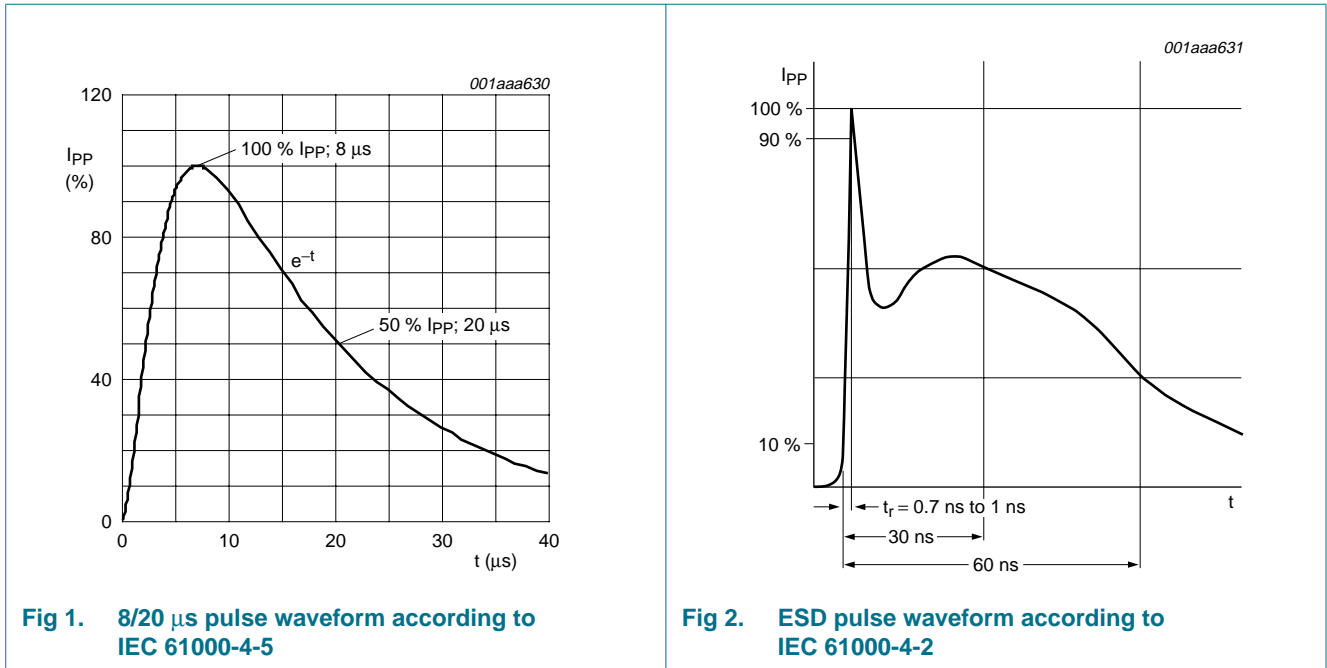
[4] Device mounted on an FR4 PCB, single-sided copper, tin-plated, mounting pad for cathode 1 cm<sup>2</sup>.**Table 7. ESD maximum ratings***T<sub>amb</sub> = 25 °C unless otherwise specified.*

Symbol	Parameter	Conditions	Min	Max	Unit
V <sub>ESD</sub>	electrostatic discharge voltage	IEC 61000-4-2 (contact discharge)	[1] -	30	kV
		machine model	-	400	V
		MIL-STD-883 (human body model)	-	16	kV

[1] Device stressed with ten non-repetitive ESD pulses.

**Table 8. ESD standards compliance**

Standard	Conditions
IEC 61000-4-2; level 4 (ESD)	> 15 kV (air); > 8 kV (contact)
MIL-STD-883; class 3 (human body model)	> 4 kV



## 6. Thermal characteristics

**Table 9. Thermal characteristics**

Symbol	Parameter	Conditions	Min	Typ	Max	Unit	
R <sub>th(j-a)</sub>	thermal resistance from junction to ambient	in free air	[1]	-	-	345	K/W
			[2]	-	-	250	K/W
R <sub>th(j-sp)</sub>	thermal resistance from junction to solder point		[3]	-	-	90	K/W

[1] Device mounted on an FR4 PCB, single-sided copper, tin-plated and standard footprint.

[2] Device mounted on an FR4 PCB, single-sided copper, tin-plated, mounting pad for cathode 1 cm<sup>2</sup>.

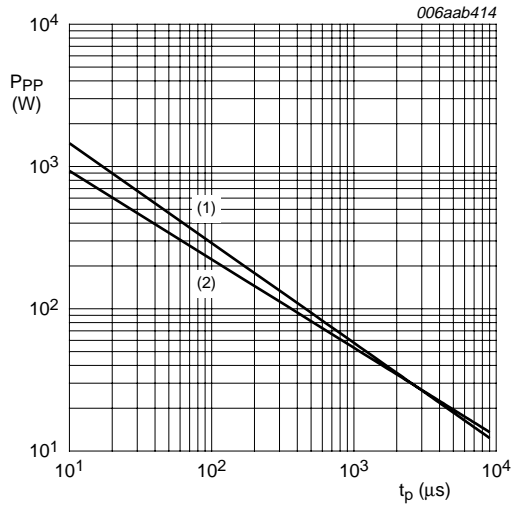
[3] Soldering point of cathode tab.

## 7. Characteristics

**Table 10. Characteristics**
*T<sub>amb</sub> = 25 °C unless otherwise specified.*

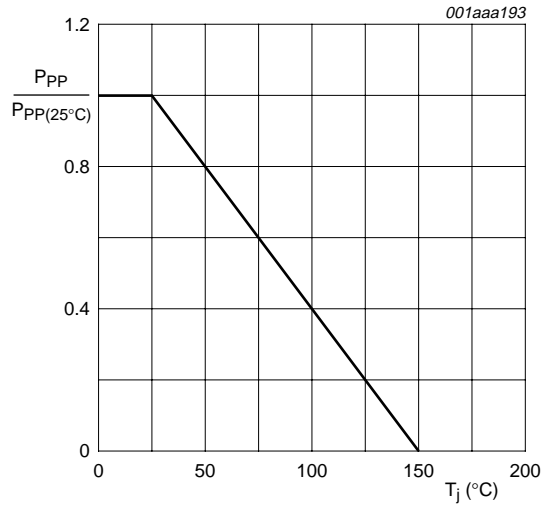
Symbol	Parameter	Conditions	Min	Typ	Max	Unit
V <sub>RWM</sub>	reverse standoff voltage					
	PESD5V0S1UA		-	-	5	V
	PESD12VS1UA		-	-	12	V
I <sub>RM</sub>	reverse leakage current					
	PESD5V0S1UA	V <sub>RWM</sub> = 5 V	-	0.3	4	μA
	PESD12VS1UA	V <sub>RWM</sub> = 12 V	-	< 1	100	nA
V <sub>BR</sub>	breakdown voltage	I <sub>R</sub> = 5 mA				
	PESD5V0S1UA		6.2	6.8	7.3	V
	PESD12VS1UA		13.3	14.5	15.75	V
C <sub>d</sub>	diode capacitance	f = 1 MHz; V <sub>R</sub> = 0 V				
	PESD5V0S1UA		-	480	530	pF
	PESD12VS1UA		-	160	180	pF
V <sub>CL</sub>	clamping voltage		[1]			
	PESD5V0S1UA	I <sub>PP</sub> = 47 A	-	-	19	V
		I <sub>PP</sub> = 25 A	-	-	13.5	V
		I <sub>PP</sub> = 5 A	-	-	9.8	V
	PESD12VS1UA	I <sub>PP</sub> = 22.5 A	-	-	27	V
		I <sub>PP</sub> = 15 A	-	-	23.5	V
I <sub>PP</sub> = 5 A		-	-	19	V	
r <sub>dif</sub>	differential resistance	I <sub>R</sub> = 5 mA				
	PESD5V0S1UA		-	2	100	Ω
	PESD12VS1UA		-	5	100	Ω

[1] Non-repetitive current pulse 8/20 μs exponential decay waveform according to IEC 61000-4-5.

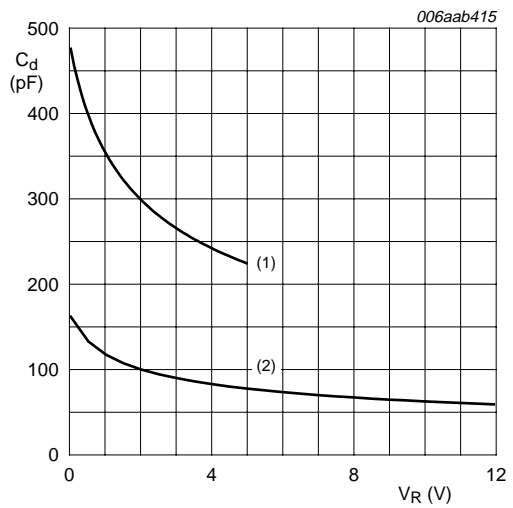


$T_{amb} = 25\text{ }^\circ\text{C}$   
 (1) PESD5V0S1UA  
 (2) PESD12VS1UA

**Fig 3. Peak pulse power as a function of exponential pulse duration; typical values**

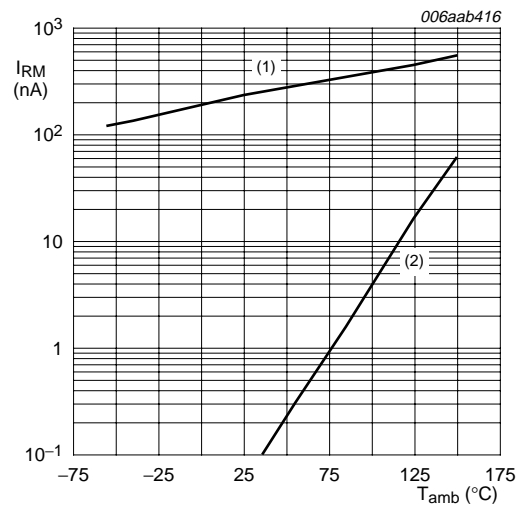


**Fig 4. Relative variation of peak pulse power as a function of junction temperature; typical values**



$f = 1\text{ MHz}; T_{amb} = 25\text{ }^\circ\text{C}$   
 (1) PESD5V0S1UA  
 (2) PESD12VS1UA

**Fig 5. Diode capacitance as a function of reverse voltage; typical values**



(1) PESD5V0S1UA  
 (2) PESD12VS1UA

**Fig 6. Reverse leakage current as a function of ambient temperature; typical values**

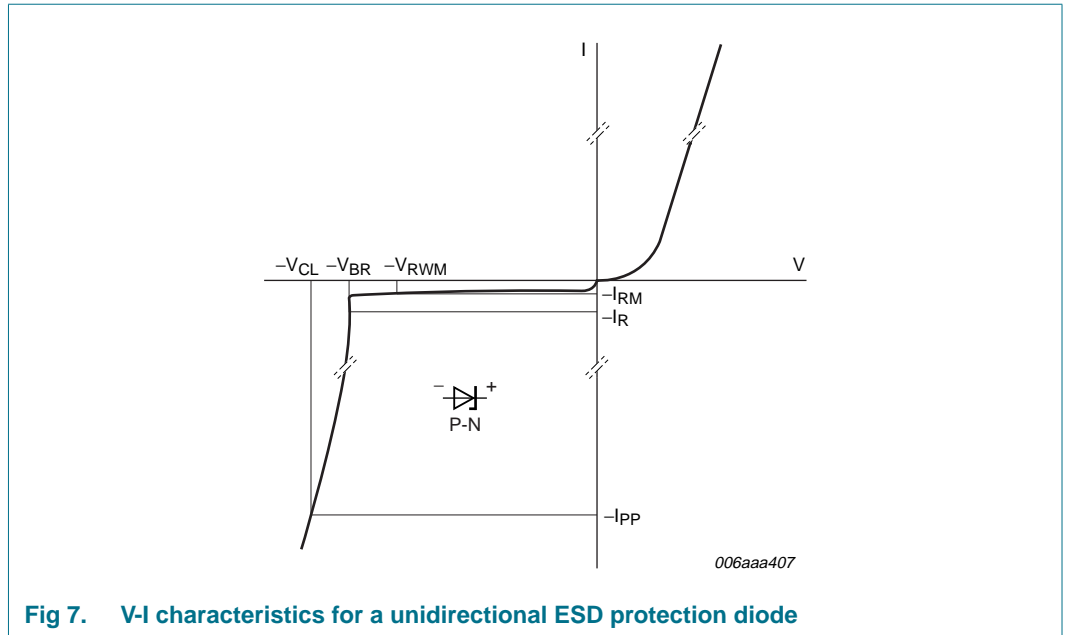
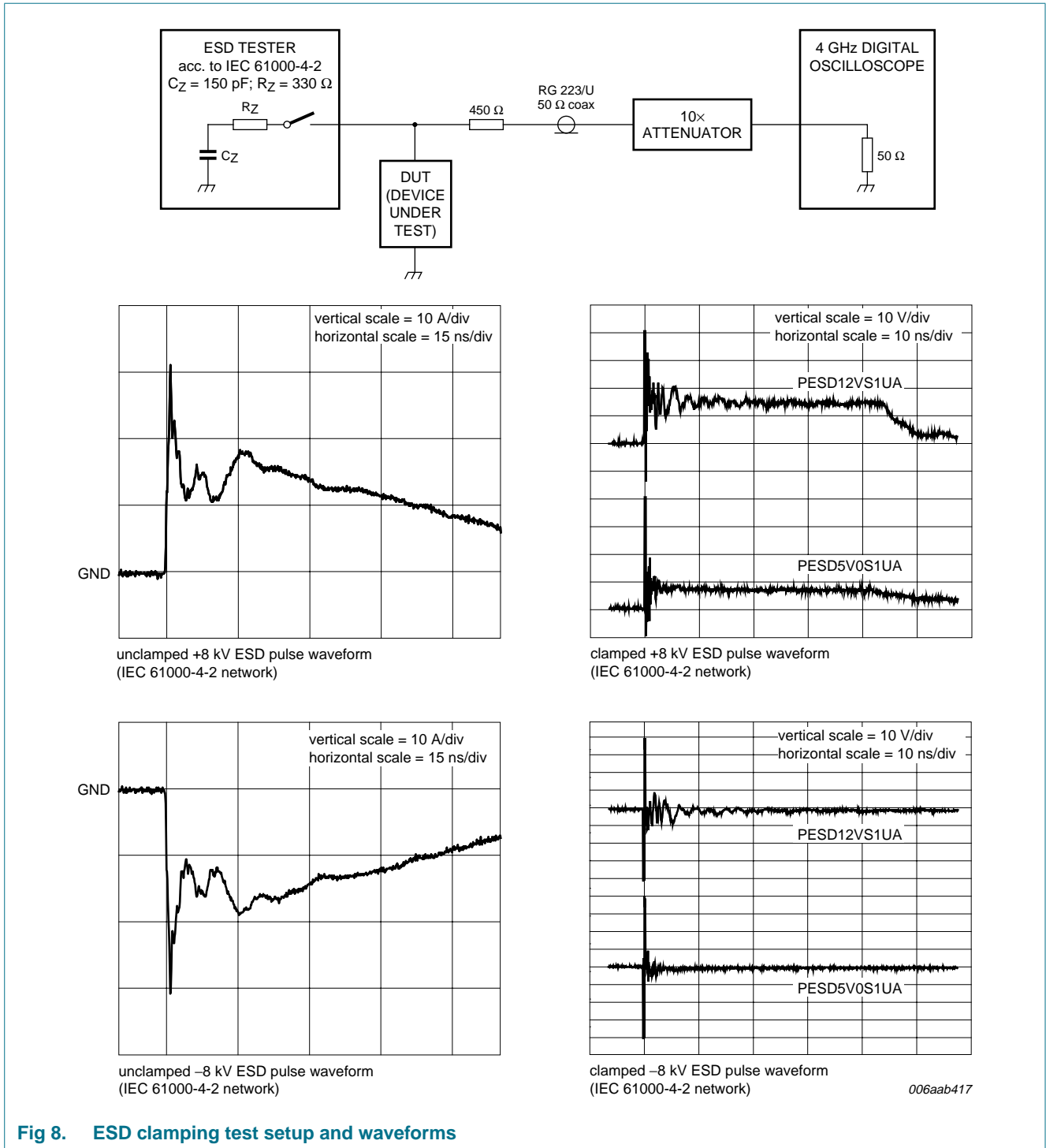


Fig 7. V-I characteristics for a unidirectional ESD protection diode



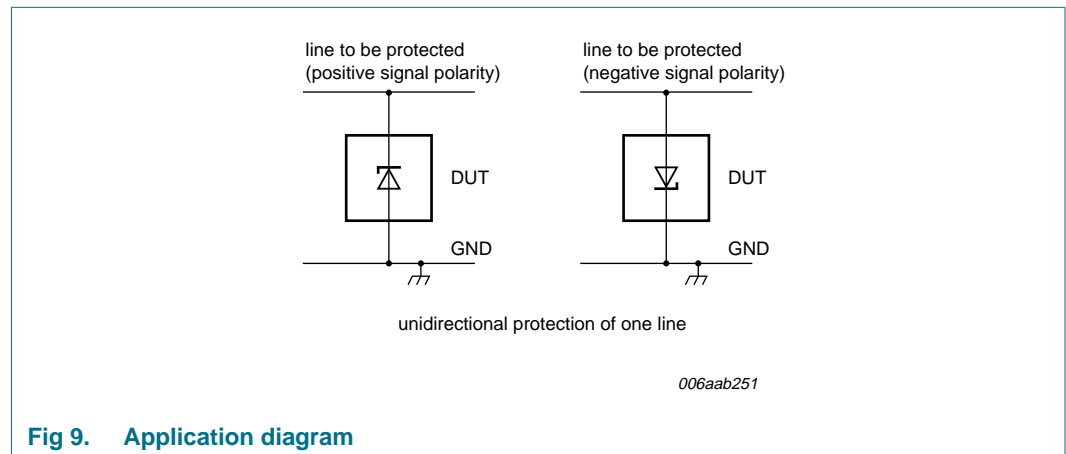
**Fig 8. ESD clamping test setup and waveforms**



## 8. Application information

PESD5V0S1UA and PESD12VS1UA are designed for the protection of one unidirectional data or signal line from the damage caused by ESD and transient overvoltage. The devices may be used on lines where the signal polarities are either positive or negative with respect to ground.

The PESD5V0S1UA provides a surge capability of 890 W and the PESD12VS1UA provides a surge capability of 600 W per line for an 8/20  $\mu$ s waveform.



**Fig 9. Application diagram**

### Circuit board layout and protection device placement

Circuit board layout is critical for the suppression of ESD and Electrical Fast Transient (EFT). The following guidelines are recommended:

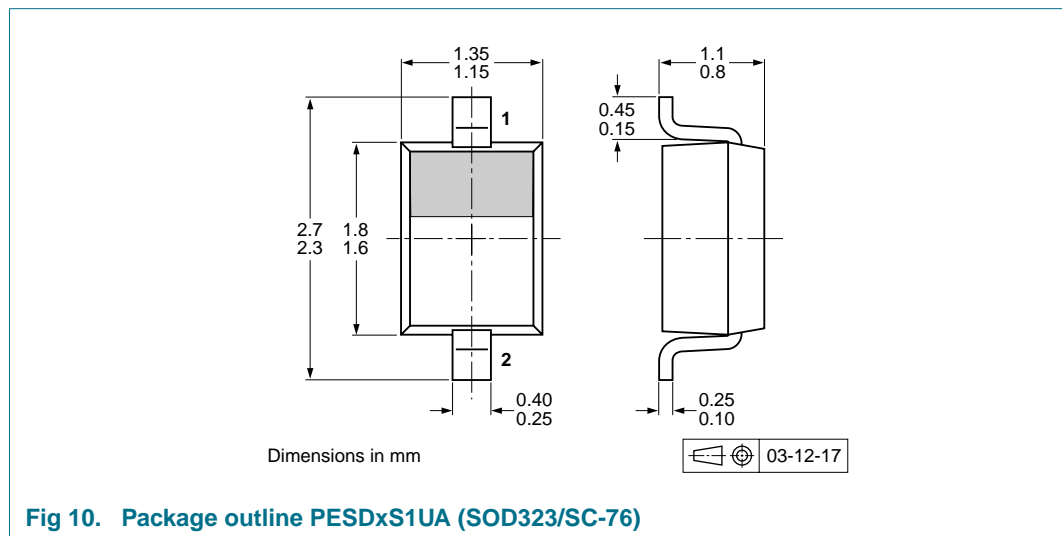
1. Place the device as close to the input terminal or connector as possible.
2. The path length between the device and the protected line should be minimized.
3. Keep parallel signal paths to a minimum.
4. Avoid running protected conductors in parallel with unprotected conductors.
5. Minimize all Printed-Circuit Board (PCB) conductive loops including power and ground loops.
6. Minimize the length of the transient return path to ground.
7. Avoid using shared transient return paths to a common ground point.
8. Ground planes should be used whenever possible. For multilayer PCBs, use ground vias.

## 9. Test information

### 9.1 Quality information

This product has been qualified in accordance with the Automotive Electronics Council (AEC) standard *Q101 - Stress test qualification for discrete semiconductors*, and is suitable for use in automotive applications.

## 10. Package outline



## 11. Packing information

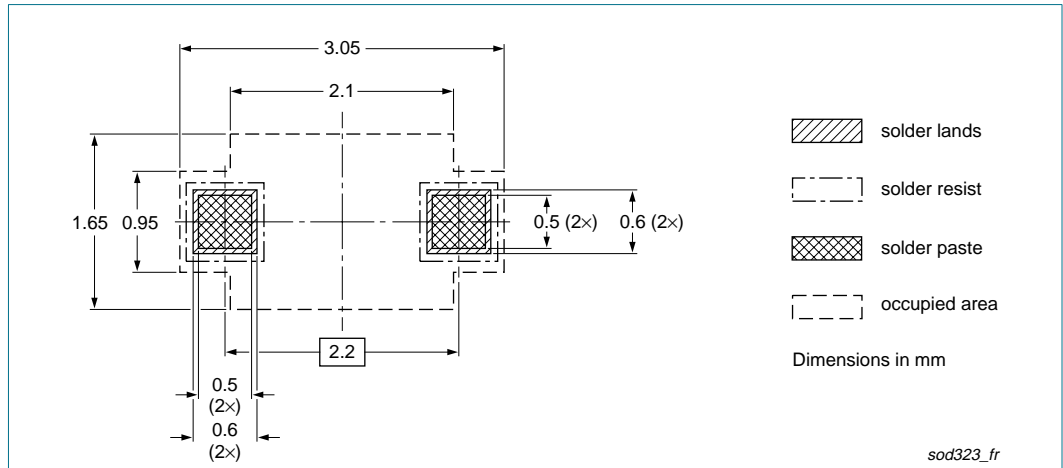
**Table 11. Packing methods**

The indicated -xxx are the last three digits of the 12NC ordering code.<sup>[1]</sup>

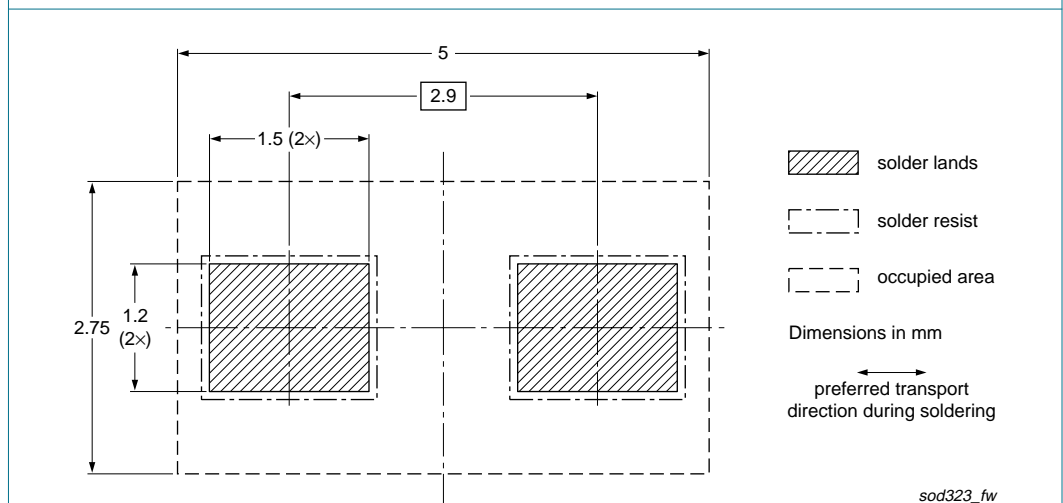
Type number	Package	Description	Packing quantity	
			3000	10000
PESD5V0S1UA	SOD323	4 mm pitch, 8 mm tape and reel	-115	-135
PESD12VS1UA				

[1] For further information and the availability of packing methods, see [Section 15](#).

## 12. Soldering



**Fig 11. Reflow soldering footprint PESDxS1UA (SOD323/SC-76)**



**Fig 12. Wave soldering footprint PESDxS1UA (SOD323/SC-76)**

### 13. Revision history

**Table 12. Revision history**

Document ID	Release date	Data sheet status	Change notice	Supersedes
PESD5V0S1UA_PESD12VS1UA_1	20090209	Product data sheet	-	-

## 14. Legal information

### 14.1 Data sheet status

Document status <sup>[1][2]</sup>	Product status <sup>[3]</sup>	Definition
Objective [short] data sheet	Development	This document contains data from the objective specification for product development.
Preliminary [short] data sheet	Qualification	This document contains data from the preliminary specification.
Product [short] data sheet	Production	This document contains the product specification.

[1] Please consult the most recently issued document before initiating or completing a design.

[2] The term 'short data sheet' is explained in section "Definitions".

[3] The product status of device(s) described in this document may have changed since this document was published and may differ in case of multiple devices. The latest product status information is available on the Internet at URL <http://www.nexperia.com>.

### 14.2 Definitions

**Draft** — The document is a draft version only. The content is still under internal review and subject to formal approval, which may result in modifications or additions. Nexperia does not give any representations or warranties as to the accuracy or completeness of information included herein and shall have no liability for the consequences of use of such information.

**Short data sheet** — A short data sheet is an extract from a full data sheet with the same product type number(s) and title. A short data sheet is intended for quick reference only and should not be relied upon to contain detailed and full information. For detailed and full information see the relevant full data sheet, which is available on request via the local Nexperia sales office. In case of any inconsistency or conflict with the short data sheet, the full data sheet shall prevail.

### 14.3 Disclaimers

**General** — Information in this document is believed to be accurate and reliable. However, Nexperia does not give any representations or warranties, expressed or implied, as to the accuracy or completeness of such information and shall have no liability for the consequences of use of such information.

**Right to make changes** — Nexperia reserves the right to make changes to information published in this document, including without limitation specifications and product descriptions, at any time and without notice. This document supersedes and replaces all information supplied prior to the publication hereof.

**Suitability for use** — Nexperia products are not designed, authorized or warranted to be suitable for use in medical, military, aircraft, space or life support equipment, nor in applications where failure or malfunction of a Nexperia product can reasonably be expected to result in personal injury, death or severe property or environmental

damage. Nexperia accepts no liability for inclusion and/or use of Nexperia products in such equipment or applications and therefore such inclusion and/or use is at the customer's own risk.

**Applications** — Applications that are described herein for any of these products are for illustrative purposes only. Nexperia makes no representation or warranty that such applications will be suitable for the specified use without further testing or modification.

**Limiting values** — Stress above one or more limiting values (as defined in the Absolute Maximum Ratings System of IEC 60134) may cause permanent damage to the device. Limiting values are stress ratings only and operation of the device at these or any other conditions above those given in the Characteristics sections of this document is not implied. Exposure to limiting values for extended periods may affect device reliability.

**Terms and conditions of sale** — Nexperia products are sold subject to the general terms and conditions of commercial sale, as published at <http://www.nexperia.com/profile/terms>, including those pertaining to warranty, intellectual property rights infringement and limitation of liability, unless explicitly otherwise agreed to in writing by Nexperia. In case of any inconsistency or conflict between information in this document and such terms and conditions, the latter will prevail.

**No offer to sell or license** — Nothing in this document may be interpreted or construed as an offer to sell products that is open for acceptance or the grant, conveyance or implication of any license under any copyrights, patents or other industrial or intellectual property rights.

**Quick reference data** — The Quick reference data is an extract of the product data given in the Limiting values and Characteristics sections of this document, and as such is not complete, exhaustive or legally binding.

### 14.4 Trademarks

Notice: All referenced brands, product names, service names and trademarks are the property of their respective owners.

## 15. Contact information

For more information, please visit: <http://www.nexperia.com>

For sales office addresses, please send an email to: [salesaddresses@nexperia.com](mailto:salesaddresses@nexperia.com)

## 16. Contents

---

<b>1</b>	<b>Product profile</b> . . . . .	<b>1</b>
1.1	General description . . . . .	1
1.2	Features . . . . .	1
1.3	Applications . . . . .	1
1.4	Quick reference data . . . . .	1
<b>2</b>	<b>Pinning information</b> . . . . .	<b>2</b>
<b>3</b>	<b>Ordering information</b> . . . . .	<b>2</b>
<b>4</b>	<b>Marking</b> . . . . .	<b>2</b>
<b>5</b>	<b>Limiting values</b> . . . . .	<b>2</b>
<b>6</b>	<b>Thermal characteristics</b> . . . . .	<b>4</b>
<b>7</b>	<b>Characteristics</b> . . . . .	<b>5</b>
<b>8</b>	<b>Application information</b> . . . . .	<b>9</b>
<b>9</b>	<b>Test information</b> . . . . .	<b>10</b>
9.1	Quality information . . . . .	10
<b>10</b>	<b>Package outline</b> . . . . .	<b>10</b>
<b>11</b>	<b>Packing information</b> . . . . .	<b>10</b>
<b>12</b>	<b>Soldering</b> . . . . .	<b>11</b>
<b>13</b>	<b>Revision history</b> . . . . .	<b>12</b>
<b>14</b>	<b>Legal information</b> . . . . .	<b>13</b>
14.1	Data sheet status . . . . .	13
14.2	Definitions . . . . .	13
14.3	Disclaimers . . . . .	13
14.4	Trademarks . . . . .	13
<b>15</b>	<b>Contact information</b> . . . . .	<b>13</b>
<b>16</b>	<b>Contents</b> . . . . .	<b>14</b>