

CBTD3861

10-bit level shifting bus switch with output enable

Rev. 2 — 21 November 2011

Product data sheet

1. General description

The CBTD3861 provides ten bits of high-speed TTL-compatible bus switching. The low ON resistance of the switch allows connections to be made with minimal propagation delay.

The CBTD3861 device is organized as one 10-bit bus switches with one output enable (\overline{OE}) input. When \overline{OE} is LOW, the switch is on and port A is connected to the B port. When \overline{OE} is HIGH, each switch is disabled.

The CBTD3861 is characterized for operation from $-40\text{ }^{\circ}\text{C}$ to $+85\text{ }^{\circ}\text{C}$.

2. Features and benefits

- Designed to be used in 5 V to 3.3 V level shifting applications with internal diode
- $5\ \Omega$ switch connection between two ports
- TTL-compatible control input levels
- Multiple package options
- Latch-up protection exceeds 100 mA per JESD78
- ESD protection:
 - ◆ HBM JESD22-A114F exceeds 2000 V
 - ◆ CDM JESD22-C101C exceeds 1000 V

3. Ordering information

Table 1. Ordering information

Type number	Package			
	Temperature range	Name	Description	Version
CBTD3861PW	$-40\text{ }^{\circ}\text{C}$ to $+85\text{ }^{\circ}\text{C}$	TSSOP24	plastic thin shrink small outline package; 24 leads; body width 4.4 mm	SOT355-1
CBTD3861DK	$-40\text{ }^{\circ}\text{C}$ to $+85\text{ }^{\circ}\text{C}$	SSOP24 ^[1]	plastic shrink small outline package; 24 leads; body width 3.9 mm; lead pitch 0.635 mm	SOT556-1
CBTD3861BQ	$-40\text{ }^{\circ}\text{C}$ to $+85\text{ }^{\circ}\text{C}$	DHVQFN24	plastic dual in-line compatible thermal enhanced very thin quad flat package; no leads; 24 terminals; body $3.5 \times 5.5 \times 0.85$ mm	SOT815-1

[1] Also known as QSOP24 package

4. Functional diagram

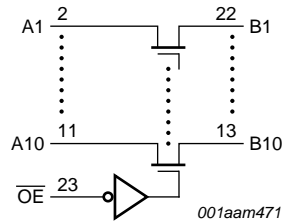

Fig 1. Logic diagram

5. Pinning information

5.1 Pinning

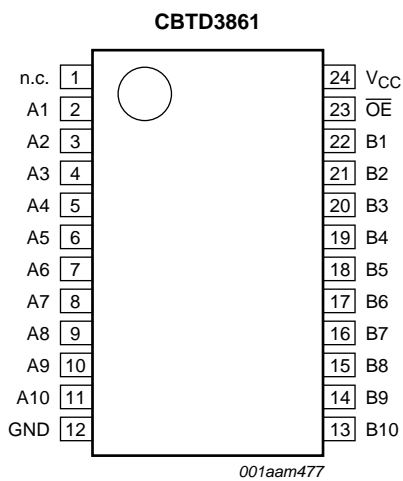

Fig 2. Pin configuration for TSSOP24 (SOT355-1)

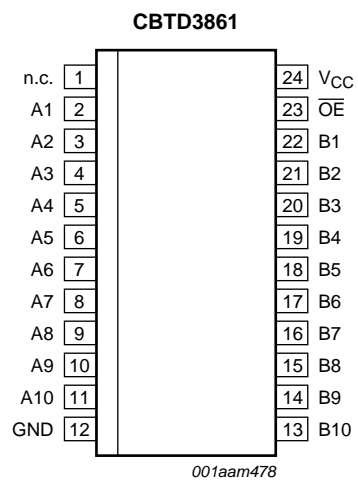
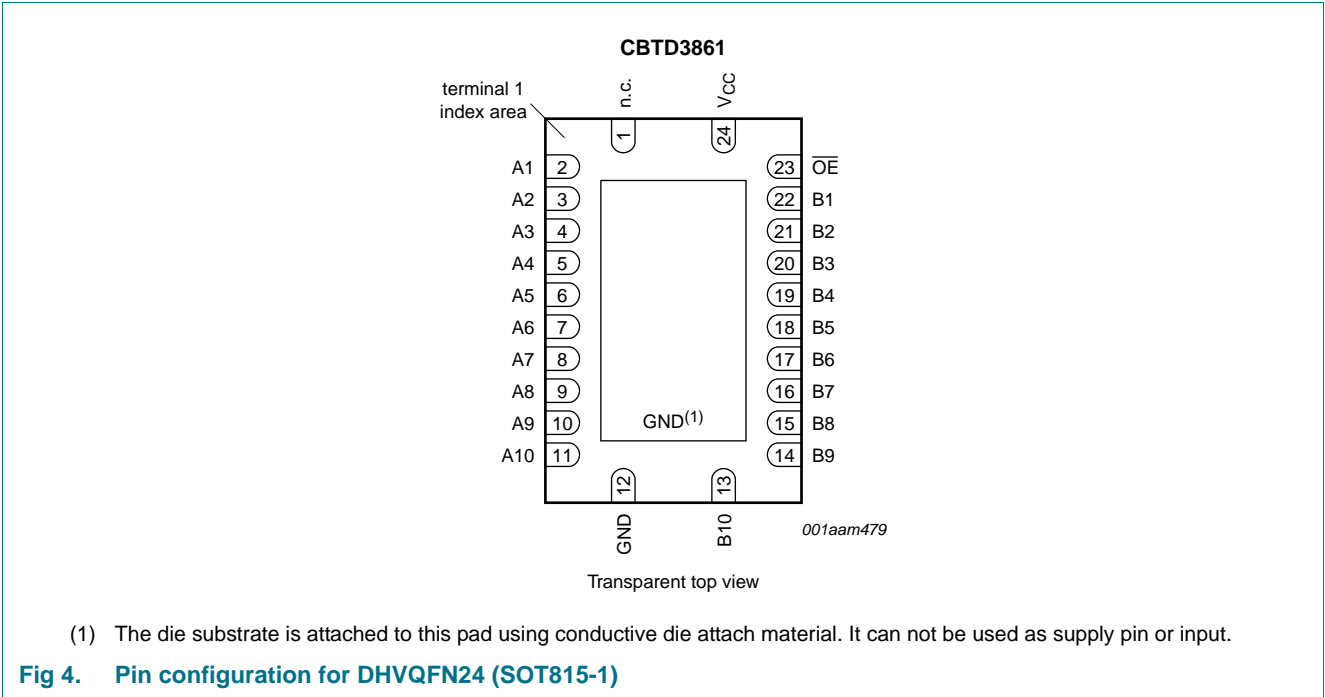

Fig 3. Pin configuration for SSOP24 (SOT556-1)



5.2 Pin description

Table 2. Pin description

Symbol	Pin	Description
n.c.	1	not connected
A1 to A10	2, 3, 4, 5, 6, 7, 8, 9, 10, 11	data input/output (A port)
GND	12	ground (0 V)
B1 to B10	22, 21, 20, 19, 18, 17, 16, 15, 14, 13	data input/output (B port)
\overline{OE}	23	output enable input (active LOW)
V _{CC}	24	positive supply voltage

6. Functional description

Table 3. Function selection^[1]

Input	Input/output
\overline{OE}	An, Bn
L	An = Bn
H	Z

[1] H = HIGH voltage level; L = LOW voltage level; Z = high-impedance OFF-state.

7. Limiting values

Table 4. Limiting values

In accordance with the Absolute Maximum Rating System (IEC 60134).^[1]

$T_{amb} = -40\text{ °C}$ to $+85\text{ °C}$, unless otherwise specified.

Symbol	Parameter	Conditions	Min	Max	Unit
V_{CC}	supply voltage		-0.5	+7.0	V
V_I	input voltage		^[2] -0.5	+7.0	V
I_O	output current	$V_O < 0\text{ V}$	-	±128	mA
I_{IK}	input clamping current	$V_{I/O} = 0\text{ V}$	-50	-	mA
T_{stg}	storage temperature		-65	+150	°C

[1] Stresses beyond those listed may cause permanent damage to the device. These are stress ratings only and functional operation of the device at these or any other conditions beyond those indicated under [Section 8](#), is not implied. Exposure to absolute-maximum-rated conditions for extended periods may affect device reliability.

[2] The input and output negative-voltage ratings may be exceeded if the input and output clamp-current ratings are observed.

8. Recommended operating conditions

Table 5. Operating conditions

All unused control inputs of the device must be held at V_{CC} or GND to ensure proper device operation.

Symbol	Parameter	Conditions	Min	Typ	Max	Unit
V_{CC}	supply voltage		4.5	-	5.5	V
V_{IH}	HIGH-state input voltage		2.0	-	-	V
V_{IL}	LOW-state input voltage		-	-	0.8	V
T_{amb}	ambient temperature	operating in free air	-40	-	+85	°C

9. Static characteristics

Table 6. Static characteristics

Voltages are referenced to GND (ground = 0 V).

Symbol	Parameter	Conditions	$T_{amb} = -40\text{ °C}$ to $+85\text{ °C}$			Unit
			Min	Typ ^[1]	Max	
V_{IK}	input clamping voltage	$V_{CC} = 4.5\text{ V}$; $I_I = -18\text{ mA}$	-	-	-1.2	V
I_I	input leakage current	$V_{CC} = 5.5\text{ V}$; $V_I = \text{GND}$ or 5.5 V	-	-	±1	μA
I_{CC}	supply current	$V_{CC} = 5.5\text{ V}$; $I_O = 0\text{ mA}$; $V_I = V_{CC}$ or GND	-	-	1.5	mA
ΔI_{CC}	additional supply current	per input pin; $V_{CC} = 5.5\text{ V}$; one input at 3.4 V, other inputs at V_{CC} or GND	^[2] -	-	2.5	mA
V_{pass}	pass voltage	see Figure 5 to Figure 9	-	-	-	V
C_I	input capacitance	control pins; $V_I = 3\text{ V}$ or 0 V	-	2.5	-	pF
$C_{io(off)}$	off-state input/output capacitance	port off; $V_I = 3\text{ V}$ or 0 V ; $\overline{OE} = V_{CC}$	-	4.0	-	pF

Table 6. Static characteristics ...continued
 Voltages are referenced to GND (ground = 0 V).

Symbol	Parameter	Conditions	T _{amb} = -40 °C to +85 °C			Unit
			Min	Typ ^[1]	Max	
R _{ON}	ON resistance	V _{CC} = 4.5 V; V _I = 0 V; I _I = 64 mA ^[3]	-	5	7	Ω
		V _{CC} = 4.5 V; V _I = 0 V; I _I = 30 mA ^[3]	-	5	7	Ω
		V _{CC} = 4.5 V; V _I = 2.4 V; I _I = -15 mA ^[3]	-	17	50	Ω

- [1] All typical values are at V_{CC} = 5 V, T_{amb} = 25 °C.
- [2] This is the increase in supply current for each input that is at the specified TTL voltage level rather than V_{CC} or GND.
- [3] Measured by the voltage drop between the nAn and the nBn terminals at the indicated current through the switch. ON resistance is determined by the lowest voltage of the two (nAn or nBn) terminals.

9.1 Typical pass voltage graphs

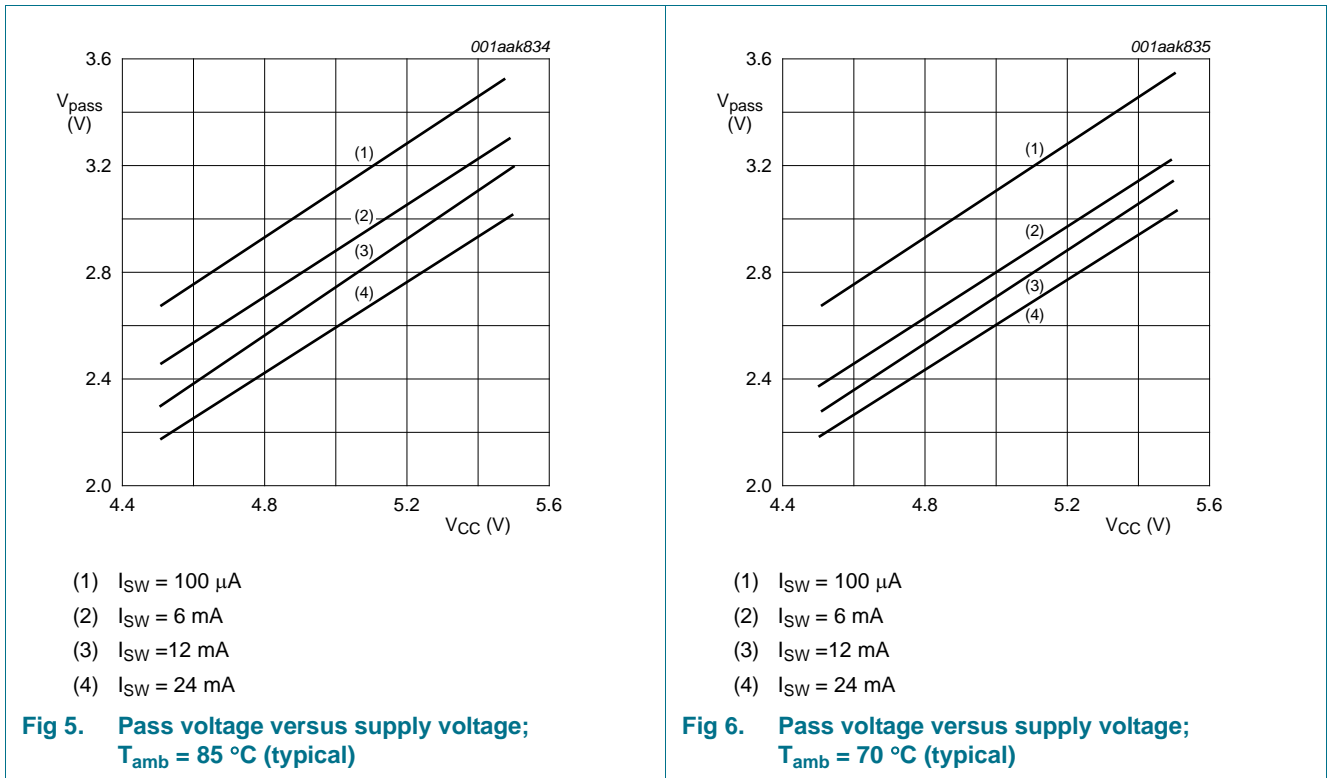

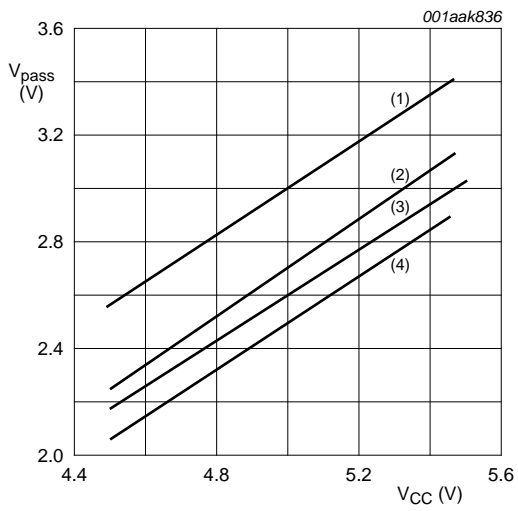

- (1) $I_{SW} = 100 \mu A$
- (2) $I_{SW} = 6 \text{ mA}$
- (3) $I_{SW} = 12 \text{ mA}$
- (4) $I_{SW} = 24 \text{ mA}$

Fig 7. Pass voltage versus supply voltage; $T_{amb} = 25 \text{ °C}$ (typical)

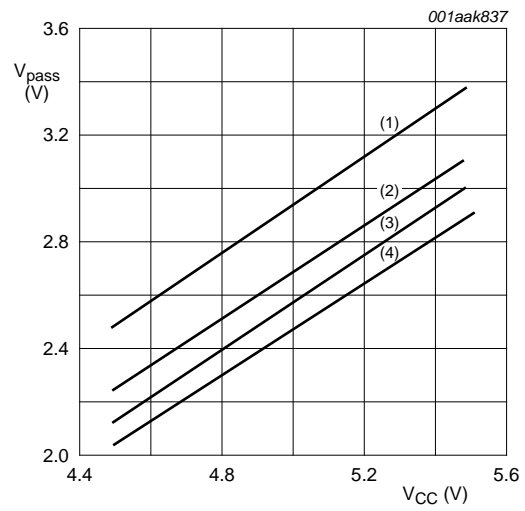

- (1) $I_{SW} = 100 \mu A$
- (2) $I_{SW} = 6 \text{ mA}$
- (3) $I_{SW} = 12 \text{ mA}$
- (4) $I_{SW} = 24 \text{ mA}$

Fig 8. Pass voltage versus supply voltage; $T_{amb} = 0 \text{ °C}$ (typical)

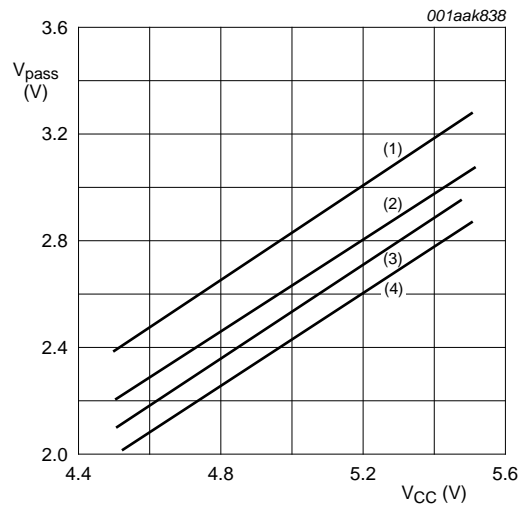

- (1) $I_{SW} = 100 \mu A$
- (2) $I_{SW} = 6 \text{ mA}$
- (3) $I_{SW} = 12 \text{ mA}$
- (4) $I_{SW} = 24 \text{ mA}$

Fig 9. Pass voltage versus supply voltage; $T_{amb} = -40 \text{ °C}$ (typical)

10. Dynamic characteristics

Table 7. Dynamic characteristics

Voltages are referenced to GND (ground = 0 V). For test circuit see [Figure 12](#).

Symbol	Parameter	Conditions	T _{amb} = -40 °C to +85 °C			Unit
			Min	Typ	Max	
t _{pd}	propagation delay	An, Bn to Bn, An; see Figure 10 [1][2] V _{CC} = 5.0 V ± 0.5 V	-	-	0.25	ns
t _{en}	enable time	OE to An or Bn; see Figure 11 [2] V _{CC} = 5.0 V ± 0.5 V	1.8	4.3	10.0	ns
t _{dis}	disable time	OE to An or Bn; see Figure 11 [2] V _{CC} = 5.0 V ± 0.5 V	1.0	3.0	6.0	ns

[1] The propagation delay is the calculated RC time constant of the typical ON resistance of the switch and the specified load capacitance, when driven by an ideal voltage source (zero output impedance).

- [2] t_{pd} is the same as t_{PLH} and t_{PHL}.
 t_{en} is the same as t_{PZL} and t_{PZH}.
 t_{dis} is the same as t_{PLZ} and t_{PHZ}.

11. Waveforms

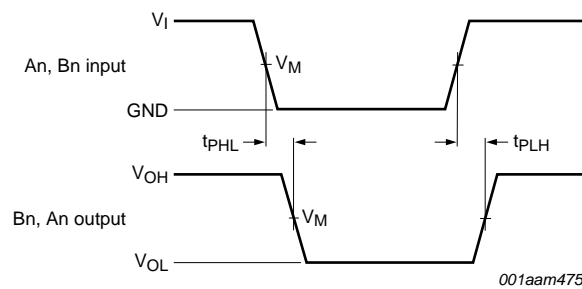

Measurement points are given in [Table 8](#).

Logic levels: V_{OL} and V_{OH} are typical output voltage levels that occur with the output load.

Fig 10. The data input (An, Bn) to output (Bn, An) propagation delay times

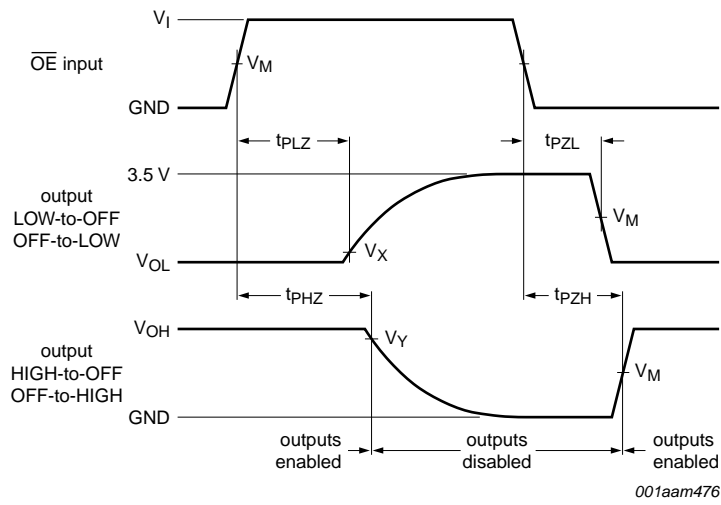

Measurement points are given in [Table 8](#).

Logic levels: V_{OL} and V_{OH} are typical output voltage levels that occur with the output load.

Fig 11. Enable and disable times

Table 8. Measurement points

Supply voltage	Input		Output		
V_{CC}	V_I	V_M	V_M	V_X	V_Y
$V_{CC} = 5.0\text{ V} \pm 0.5\text{ V}$	GND to 3.0 V	1.5 V	1.5 V	$V_{OL} + 0.3\text{ V}$	$V_{OH} - 0.3\text{ V}$

12. Test information

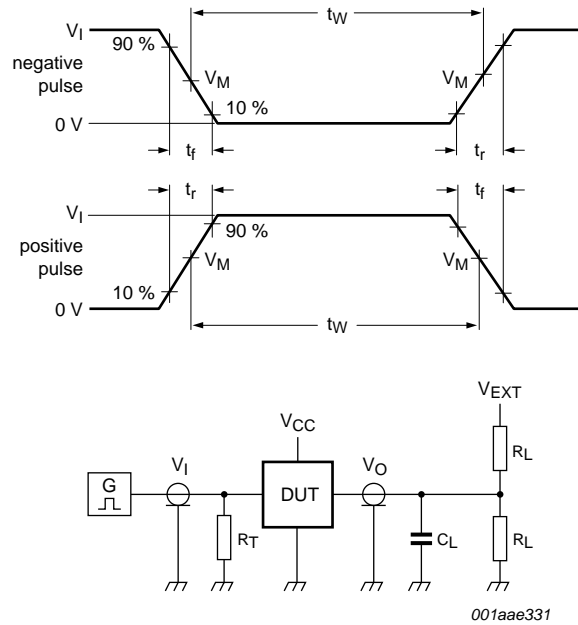

Test data is given in [Table 9](#).

All input pulses are supplied by generators having the following characteristics: PRR ≤ 10 MHz; Z_o = 50 Ω.

The outputs are measured one at a time with one transition per measurement.

Definitions for test circuit:

R_L = Load resistance.

C_L = Load capacitance including jig and probe capacitance.

R_T = Termination resistance should be equal to output impedance Z_o of the pulse generator.

V_{EXT} = External voltage for measuring switching times.

Fig 12. Test circuit for measuring switching times

Table 9. Test data

Supply voltage	Input		Load		V _{EXT}		
	V _I	t _r , t _f	C _L	R _L	t _{PLH} , t _{PHL}	t _{PLZ} , t _{PZL}	t _{PHZ} , t _{PZH}
V _{CC} = 5.0 V ± 0.5 V	GND to 3.0 V	≤ 2.5 ns	50 pF	500 Ω	open	7.0 V	open

13. Package outline

SSOP24: plastic shrink small outline package; 24 leads; body width 3.9 mm; lead pitch 0.635 mm SOT556-1

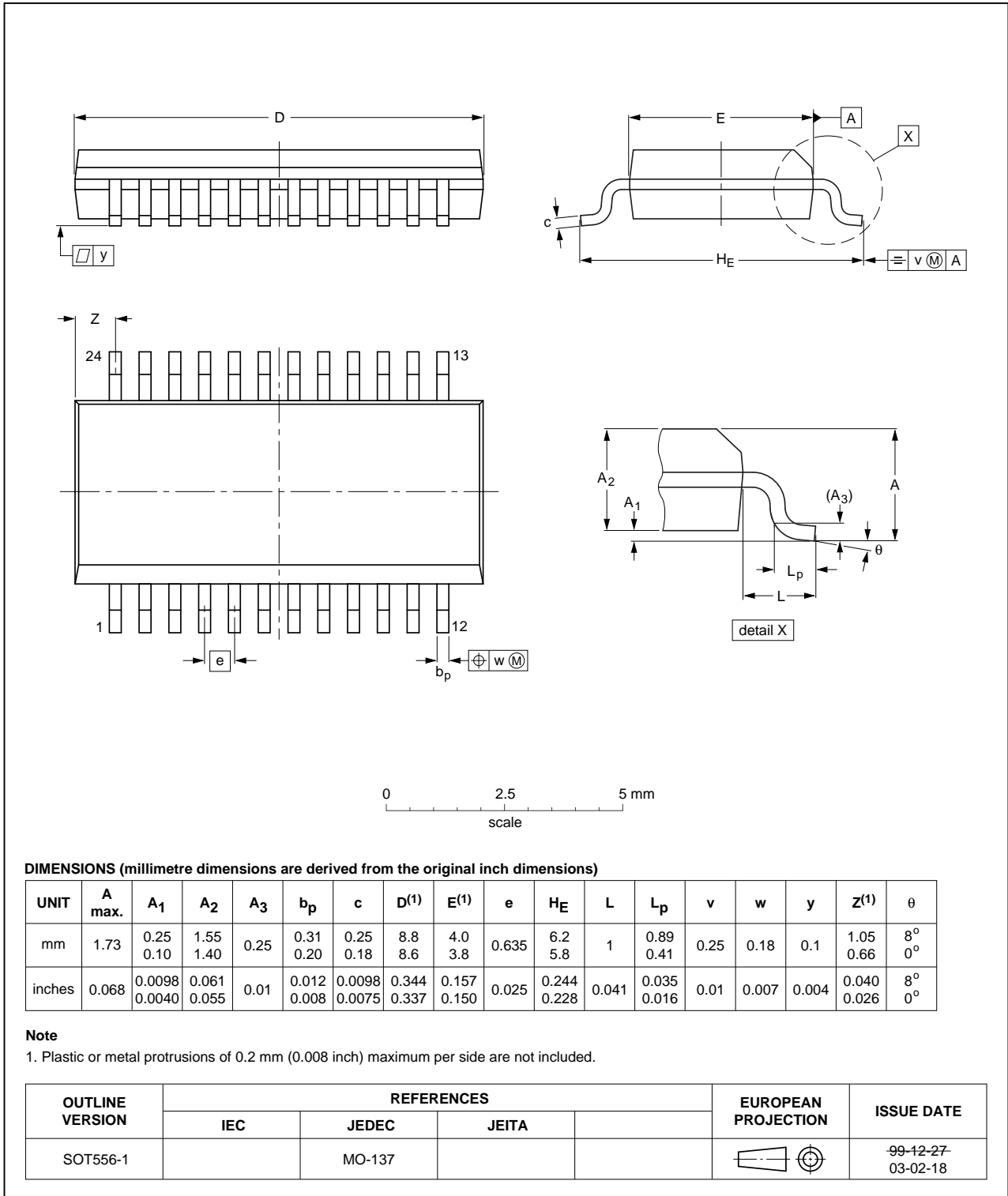

Fig 13. Package outline SOT556-1 (SSOP24)

TSSOP24: plastic thin shrink small outline package; 24 leads; body width 4.4 mm

SOT355-1

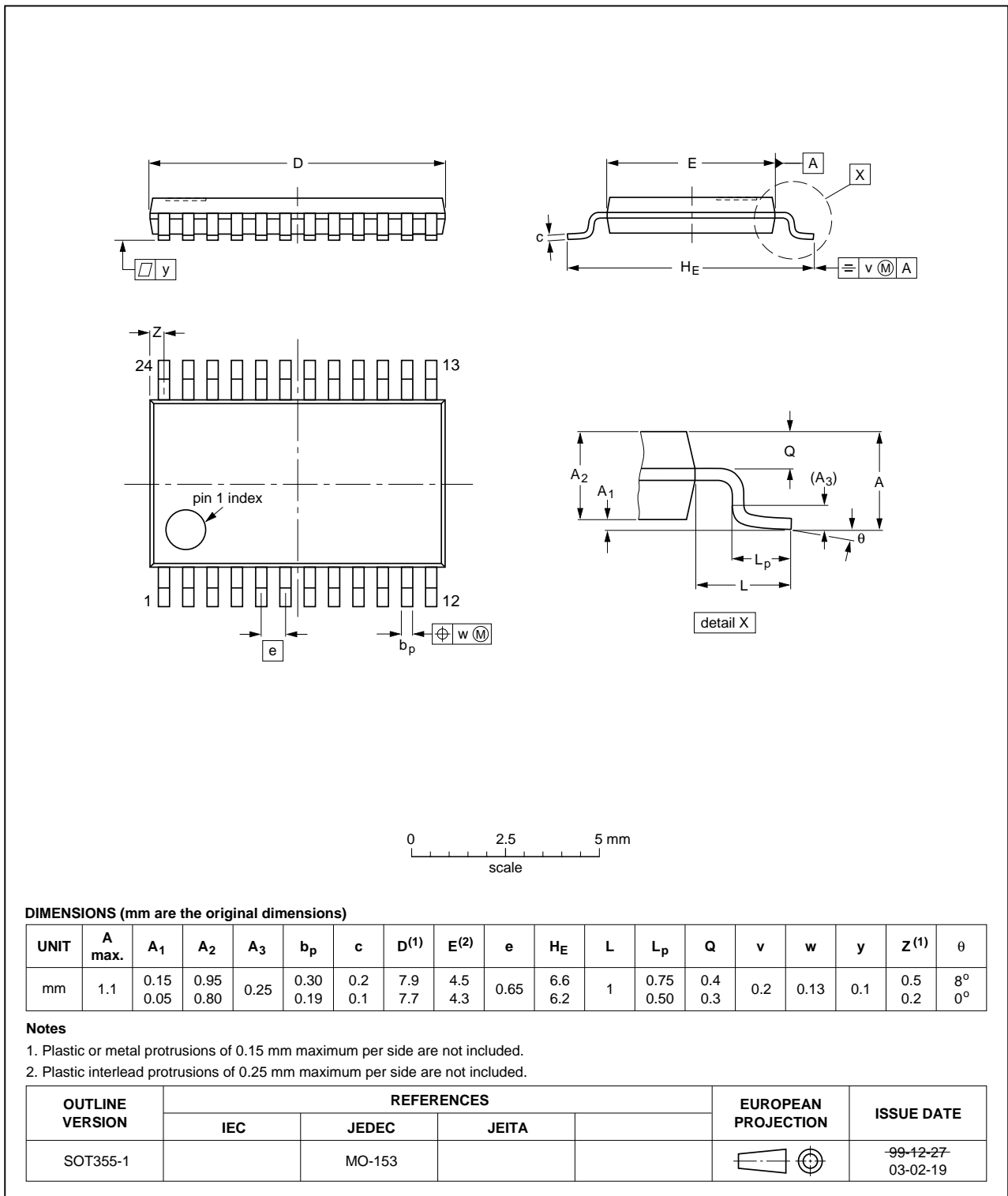

Fig 14. Package outline SOT355-1 (TSSOP24)

DHVQFN24: plastic dual in-line compatible thermal enhanced very thin quad flat package; no leads; 24 terminals; body 3.5 x 5.5 x 0.85 mm

SOT815-1

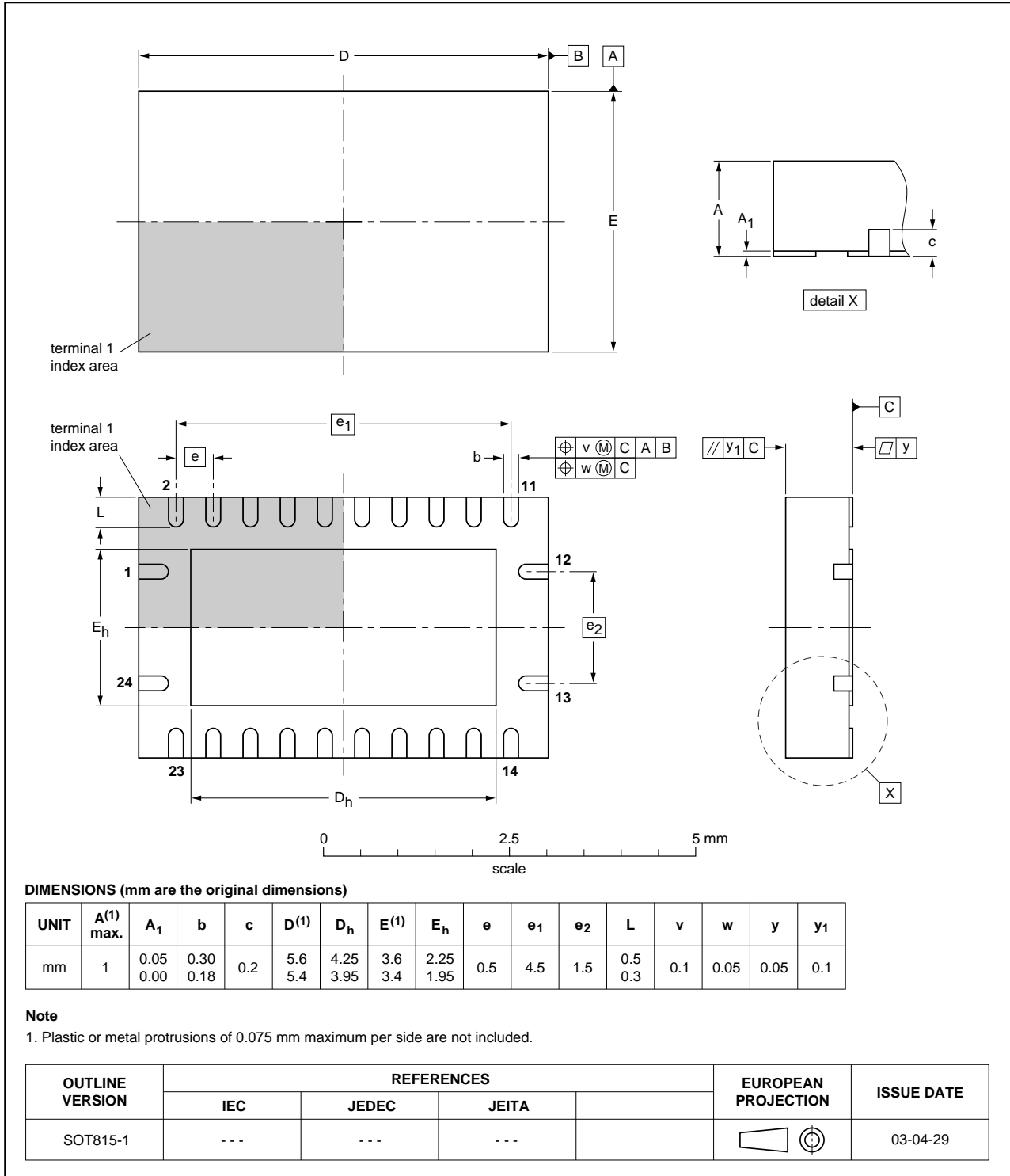

Fig 15. Package outline SOT815-1 (DHVQFN24)

14. Abbreviations

Table 10. Abbreviations

Acronym	Description
CDM	Charged Device Model
ESD	ElectroStatic Discharge
HBM	Human Body Model
PRR	Pulse Rate Repetition
TTL	Transistor-Transistor Logic

15. Revision history

Table 11. Revision history

Document ID	Release date	Data sheet status	Change notice	Supersedes
CBTD3861 v.2	20111121	Product data sheet	-	CBTD3861 v.1
Modifications:	<ul style="list-style-type: none">• Legal pages updated.			
CBTD3861 v.1	20100819	Product data sheet	-	-

16. Legal information

16.1 Data sheet status

Document status ^{[1][2]}	Product status ^[3]	Definition
Objective [short] data sheet	Development	This document contains data from the objective specification for product development.
Preliminary [short] data sheet	Qualification	This document contains data from the preliminary specification.
Product [short] data sheet	Production	This document contains the product specification.

[1] Please consult the most recently issued document before initiating or completing a design.

[2] The term 'short data sheet' is explained in section "Definitions".

[3] The product status of device(s) described in this document may have changed since this document was published and may differ in case of multiple devices. The latest product status information is available on the Internet at URL <http://www.nexperia.com>.

16.2 Definitions

Draft — The document is a draft version only. The content is still under internal review and subject to formal approval, which may result in modifications or additions. Nexperia does not give any representations or warranties as to the accuracy or completeness of information included herein and shall have no liability for the consequences of use of such information.

Short data sheet — A short data sheet is an extract from a full data sheet with the same product type number(s) and title. A short data sheet is intended for quick reference only and should not be relied upon to contain detailed and full information. For detailed and full information see the relevant full data sheet, which is available on request via the local Nexperia sales office. In case of any inconsistency or conflict with the short data sheet, the full data sheet shall prevail.

Product specification — The information and data provided in a Product data sheet shall define the specification of the product as agreed between Nexperia and its customer, unless Nexperia and customer have explicitly agreed otherwise in writing. In no event however, shall an agreement be valid in which the Nexperia product is deemed to offer functions and qualities beyond those described in the Product data sheet.

16.3 Disclaimers

Limited warranty and liability — Information in this document is believed to be accurate and reliable. However, Nexperia does not give any representations or warranties, expressed or implied, as to the accuracy or completeness of such information and shall have no liability for the consequences of use of such information.

In no event shall Nexperia be liable for any indirect, incidental, punitive, special or consequential damages (including - without limitation - lost profits, lost savings, business interruption, costs related to the removal or replacement of any products or rework charges) whether or not such damages are based on tort (including negligence), warranty, breach of contract or any other legal theory.

Notwithstanding any damages that customer might incur for any reason whatsoever, Nexperia's aggregate and cumulative liability towards customer for the products described herein shall be limited in accordance with the *Terms and conditions of commercial sale* of Nexperia.

Right to make changes — Nexperia reserves the right to make changes to information published in this document, including without limitation specifications and product descriptions, at any time and without notice. This document supersedes and replaces all information supplied prior to the publication hereof.

Suitability for use — Nexperia products are not designed, authorized or warranted to be suitable for use in life support, life-critical or safety-critical systems or equipment, nor in applications where failure or

malfunction of a Nexperia product can reasonably be expected to result in personal injury, death or severe property or environmental damage. Nexperia accepts no liability for inclusion and/or use of Nexperia products in such equipment or applications and therefore such inclusion and/or use is at the customer's own risk.

Applications — Applications that are described herein for any of these products are for illustrative purposes only. Nexperia makes no representation or warranty that such applications will be suitable for the specified use without further testing or modification.

Customers are responsible for the design and operation of their applications and products using Nexperia products, and Nexperia accepts no liability for any assistance with applications or customer product design. It is customer's sole responsibility to determine whether the Nexperia product is suitable and fit for the customer's applications and products planned, as well as for the planned application and use of customer's third party customer(s). Customers should provide appropriate design and operating safeguards to minimize the risks associated with their applications and products.

Nexperia does not accept any liability related to any default, damage, costs or problem which is based on any weakness or default in the customer's applications or products, or the application or use by customer's third party customer(s). Customer is responsible for doing all necessary testing for the customer's applications and products using Nexperia products in order to avoid a default of the applications and the products or of the application or use by customer's third party customer(s). Nexperia does not accept any liability in this respect.

Limiting values — Stress above one or more limiting values (as defined in the Absolute Maximum Ratings System of IEC 60134) will cause permanent damage to the device. Limiting values are stress ratings only and (proper) operation of the device at these or any other conditions above those given in the Recommended operating conditions section (if present) or the Characteristics sections of this document is not warranted. Constant or repeated exposure to limiting values will permanently and irreversibly affect the quality and reliability of the device.

Terms and conditions of commercial sale — Nexperia products are sold subject to the general terms and conditions of commercial sale, as published at <http://www.nexperia.com/profile/terms>, unless otherwise agreed in a valid written individual agreement. In case an individual agreement is concluded only the terms and conditions of the respective agreement shall apply. Nexperia hereby expressly objects to applying the customer's general terms and conditions with regard to the purchase of Nexperia products by customer.

No offer to sell or license — Nothing in this document may be interpreted or construed as an offer to sell products that is open for acceptance or the grant, conveyance or implication of any license under any copyrights, patents or other industrial or intellectual property rights.

Export control — This document as well as the item(s) described herein may be subject to export control regulations. Export might require a prior authorization from competent authorities.

Non-automotive qualified products — Unless this data sheet expressly states that this specific Nexperia product is automotive qualified, the product is not suitable for automotive use. It is neither qualified nor tested in accordance with automotive testing or application requirements. Nexperia accepts no liability for inclusion and/or use of non-automotive qualified products in automotive equipment or applications.

In the event that customer uses the product for design-in and use in automotive applications to automotive specifications and standards, customer (a) shall use the product without Nexperia's warranty of the product for such automotive applications, use and specifications, and (b) whenever customer uses the product for automotive applications beyond

Nexperia's specifications such use shall be solely at customer's own risk, and (c) customer fully indemnifies Nexperia for any liability, damages or failed product claims resulting from customer design and use of the product for automotive applications beyond Nexperia's standard warranty and Nexperia's product specifications.

16.4 Trademarks

Notice: All referenced brands, product names, service names and trademarks are the property of their respective owners.

17. Contact information

For more information, please visit: <http://www.nexperia.com>

For sales office addresses, please send an email to: salesaddresses@nexperia.com

18. Contents

1	General description	1
2	Features and benefits	1
3	Ordering information	1
4	Functional diagram	2
5	Pinning information	2
5.1	Pinning	2
5.2	Pin description	3
6	Functional description	3
7	Limiting values	4
8	Recommended operating conditions	4
9	Static characteristics	4
9.1	Typical pass voltage graphs	5
10	Dynamic characteristics	7
11	Waveforms	7
12	Test information	9
13	Package outline	10
14	Abbreviations	13
15	Revision history	13
16	Legal information	14
16.1	Data sheet status	14
16.2	Definitions	14
16.3	Disclaimers	14
16.4	Trademarks	15
17	Contact information	15
18	Contents	16