

Important notice

Dear Customer,

On 7 February 2017 the former NXP Standard Product business became a new company with the tradename **Nexperia**. Nexperia is an industry leading supplier of Discrete, Logic and PowerMOS semiconductors with its focus on the automotive, industrial, computing, consumer and wearable application markets

In data sheets and application notes which still contain NXP or Philips Semiconductors references, use the references to Nexperia, as shown below.

Instead of <http://www.nxp.com>, <http://www.philips.com/> or <http://www.semiconductors.philips.com/>, use <http://www.nexperia.com>

Instead of sales.addresses@www.nxp.com or sales.addresses@www.semiconductors.philips.com, use salesaddresses@nexperia.com (email)

Replace the copyright notice at the bottom of each page or elsewhere in the document, depending on the version, as shown below:

- © NXP N.V. (year). All rights reserved or © Koninklijke Philips Electronics N.V. (year). All rights reserved

Should be replaced with:

- © **Nexperia B.V. (year). All rights reserved.**

If you have any questions related to the data sheet, please contact our nearest sales office via e-mail or telephone (details via salesaddresses@nexperia.com). Thank you for your cooperation and understanding,

Kind regards,

Team Nexperia

DATA SHEET

74ALVCH162827

20-bit buffer/line driver, non-inverting,
with 30 Ω termination resistors (3-State)

Product specification

1998 Sep 29

IC24 Data Handbook

20-bit buffer/line driver, non-inverting, with 30Ω termination resistors (3-State)

74ALVCH162827

FEATURES

- Complies with JEDEC standard no. 8-1A.
- CMOS low power consumption
- Direct interface with TTL levels
- Current drive ± 12 mA at 3.0 V
- MULTIBYTE™ flow-through standard pin-out architecture
- Low inductance multiple V_{CC} and GND pins for minimum noise and ground bounce
- Integrated 30 Ω termination resistors

DESCRIPTION

The 74ALVCH162827 high-performance CMOS device combines low static and dynamic power dissipation with high speed and high output drive.

The 74ALVCH162827 20-bit buffers provide high performance bus interface buffering for wide data/address paths or buses carrying parity. They have NAND Output Enables ($n\overline{OE}1$, $n\overline{OE}2$) for maximum control flexibility.

The 74ALVCH162827 is designed with 30Ω series resistance in both the pull-up and pull-down output structures. This design reduces line noise in applications such as memory address drivers, clock drivers and bus receivers/transmitters.

To ensure the high impedance state during power up or power down, OE should be tied to V_{CC} through a pullup resistor; the minimum value of the resistor is determined by the current-sinking/current-sourcing capability of the driver.

Active bus-hold circuitry is provided to hold unused or floating data inputs at a valid logic level.

QUICK REFERENCE DATA

GND = 0V; $T_{amb} = 25^{\circ}\text{C}$; $t_r = t_f = 2.5\text{ns}$

SYMBOL	PARAMETER	CONDITIONS	TYPICAL	UNIT
t_{PHL}/t_{PLH}	Propagation delay nAn to nYn	$V_{CC} = 2.5\text{V}$, $C_L = 30\text{pF}$ $V_{CC} = 3.3\text{V}$, $C_L = 50\text{pF}$	2.9 2.9	ns
C_I	Input capacitance		5	pF
C_{PD}	Power dissipation capacitance per latch	$V_I = \text{GND to } V_{CC}^1$	Output enabled 14 Output disabled 3	pF

NOTES:

- C_{PD} is used to determine the dynamic power dissipation (P_D in μW):
 $P_D = C_{PD} \times V_{CC}^2 \times f_i + \sum (C_L \times V_{CC}^2 \times f_o)$ where:
 f_i = input frequency in MHz; C_L = output load capacity in pF;
 f_o = output frequency in MHz; V_{CC} = supply voltage in V;
 $\sum (C_L \times V_{CC}^2 \times f_o)$ = sum of outputs.

ORDERING INFORMATION

PACKAGES	TEMPERATURE RANGE	OUTSIDE NORTH AMERICA	NORTH AMERICA	DWG NUMBER
56-Pin Plastic TSSOP Type II	$-40^{\circ}\text{C to } +85^{\circ}\text{C}$	74ALVCH162827DGG	ACH162827DGG	SOT364-1

PIN DESCRIPTION

PIN NUMBER	SYMBOL	FUNCTION
55, 54, 52, 51, 49, 48, 47, 45, 44, 43, 42, 41, 40, 38, 37, 36, 34, 33, 31, 30	1A0 - 1A9 2A0 - 2A9	Data inputs
2, 3, 5, 6, 8, 9, 10, 12, 13, 14, 15, 16, 17, 19, 20, 21, 23, 24, 26, 27	1Y0 - 1Y9 2Y0 - 2Y9	Data outputs
1, 56, 28, 29	$1\overline{OE}1$ $1\overline{OE}2$, $2\overline{OE}1$, $2\overline{OE}2$	Output enable inputs (active-LOW)
4, 11, 18, 25, 32, 39, 46, 53	GND	Ground (0V)
7, 22, 35, 50	V_{CC}	Positive supply voltage

20-bit buffer/line driver, non-inverting, with 30Ω termination resistors (3-State)

74ALVCH162827

PIN CONFIGURATION

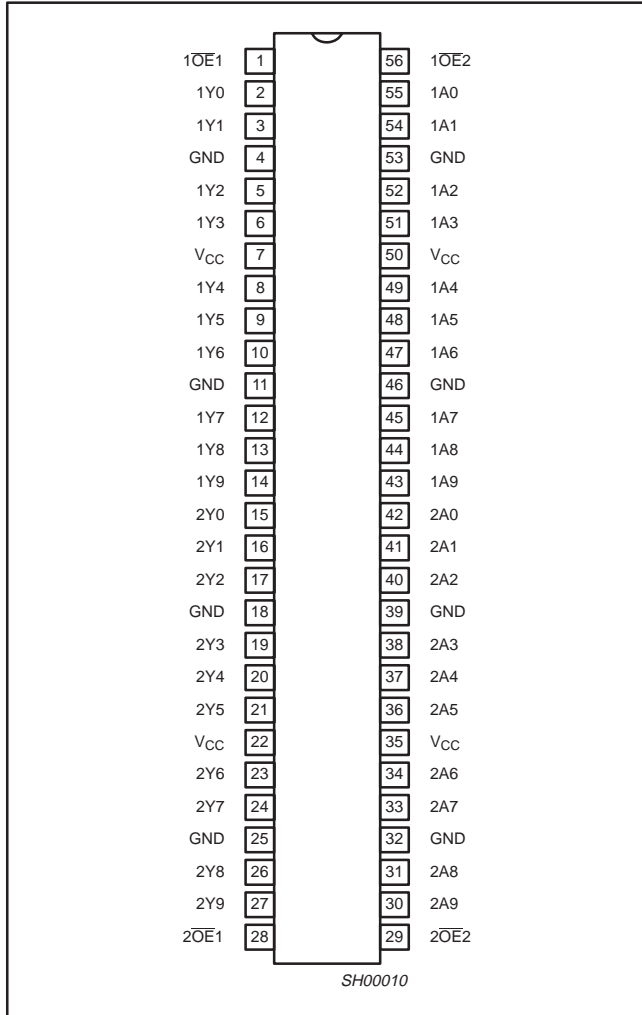

LOGIC SYMBOL (IEEE/IEC)

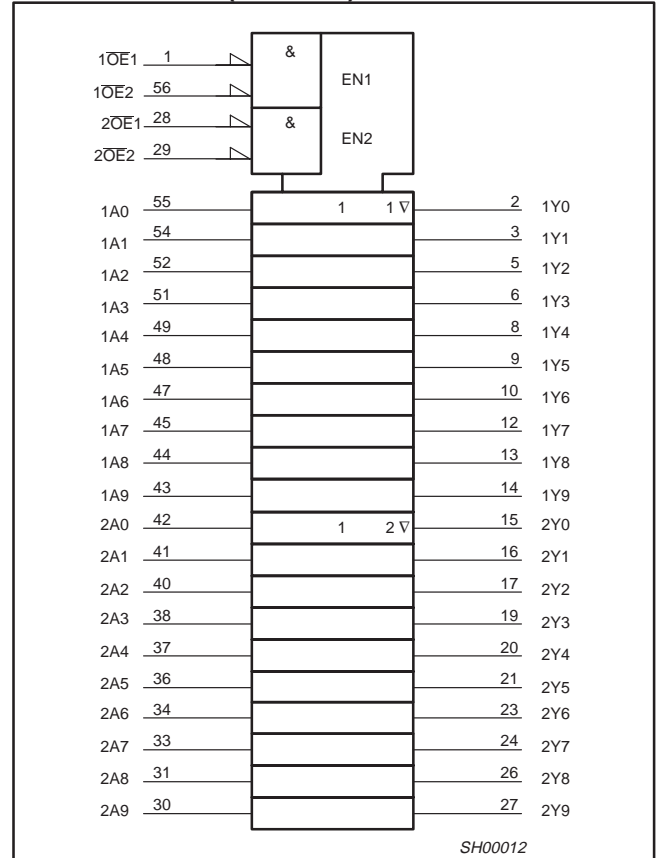

LOGIC SYMBOL

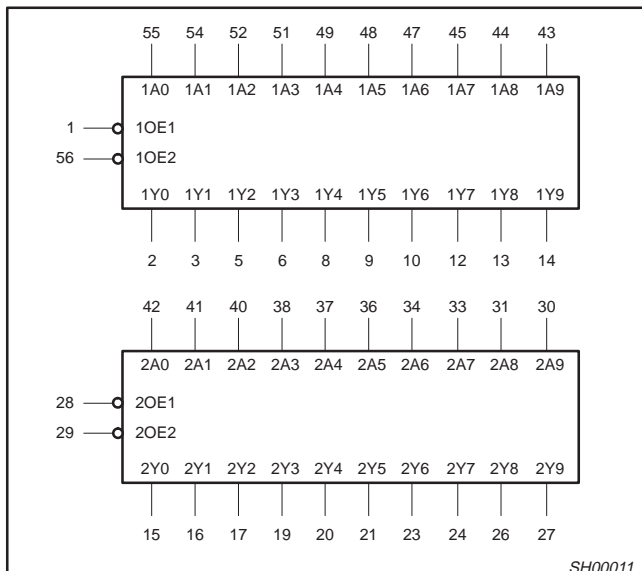

FUNCTION TABLE

INPUTS			OUTPUT	OPERATING MODE
nOE1	nOE2	nAn	nYn	
L	L	L	L	Transparent
L	L	H	H	Transparent
H	X	X	Z	High impedance
X	H	X	Z	High impedance

X = Don't care
 Z = High impedance "off" state
 H = High voltage level
 L = Low voltage level

20-bit buffer/line driver, non-inverting, with 30Ω termination resistors (3-State)

74ALVCH162827

LOGIC DIAGRAM

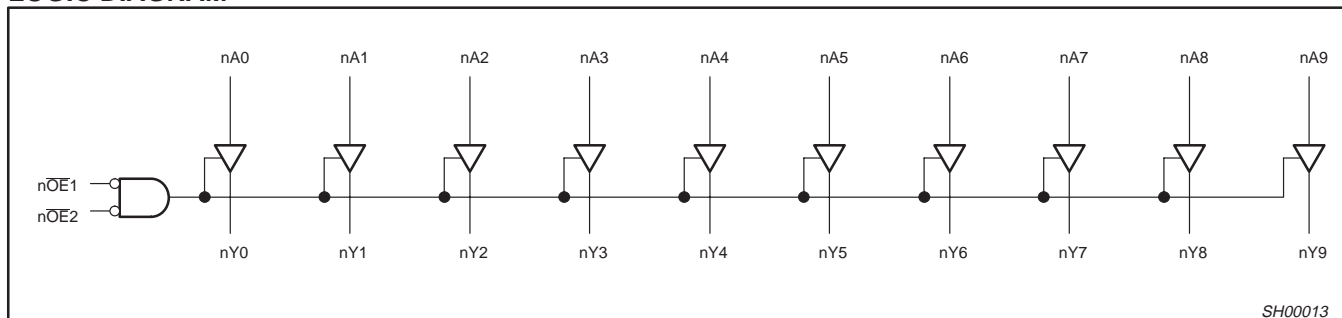

RECOMMENDED OPERATING CONDITIONS

SYMBOL	PARAMETER	CONDITIONS	MIN	MAX	UNIT
V_{CC}	DC supply voltage 2.5V range (for max. speed performance @ 30 pF output load)		2.3	2.7	V
	DC supply voltage 3.3V range (for max. speed performance @ 50 pF output load)		3.0	3.6	
V_I	DC Input voltage range		0	V_{CC}	V
V_O	DC output voltage range		0	V_{CC}	V
T_{amb}	Operating free-air temperature range		-40	+85	°C
t_r, t_f	Input rise and fall times	$V_{CC} = 2.3$ to $3.0V$ $V_{CC} = 3.0$ to $3.6V$	0	20 10	ns/V

ABSOLUTE MAXIMUM RATINGS

In accordance with the Absolute Maximum Rating System (IEC 134)

Voltages are referenced to GND (ground = 0V)

SYMBOL	PARAMETER	CONDITIONS	RATING	UNIT
V_{CC}	DC supply voltage		-0.5 to +4.6	V
I_{IK}	DC input diode current	$V_I < 0$	-50	mA
V_I	DC input voltage	Note 1	-0.5 to +4.6	V
I_{OK}	DC output diode current	$V_O > V_{CC}$ or $V_O < 0$	±50	mA
V_O	DC output voltage	Note 1	-0.5 to $V_{CC} + 0.5$	V
I_O	DC output source or sink current	$V_O = 0$ to V_{CC}	±50	mA
I_{GND}, I_{CC}	DC V_{CC} or GND current		±100	mA
T_{stg}	Storage temperature range		-65 to +150	°C
P_{TOT}	Power dissipation per package -plastic thin-medium-shrink (TSSOP)	For temperature range: -40 to +125 °C above +55°C derate linearly with 8 mW/K	600	mW

NOTE:

- The input and output voltage ratings may be exceeded if the input and output current ratings are observed.

20-bit buffer/line driver, non-inverting, with 30Ω termination resistors (3-State)

74ALVCH162827

DC ELECTRICAL CHARACTERISTICS

Over recommended operating conditions. Voltage are referenced to GND (ground = 0 V).

SYMBOL	PARAMETER	TEST CONDITIONS	LIMITS			UNIT
			Temp = -40°C to +85°C			
			MIN	TYP ¹	MAX	
V _{IH}	HIGH level Input voltage	V _{CC} = 2.3 to 2.7V	1.7	1.2		V
		V _{CC} = 2.7 to 3.6V	2.0	1.5		
V _{IL}	LOW level Input voltage	V _{CC} = 2.3 to 2.7V		1.2	0.7	V
		V _{CC} = 2.7 to 3.6V		1.5	0.8	
V _{OH}	HIGH level output voltage	V _{CC} = 2.3 to 3.6V; V _I = V _{IH} or V _{IL} ; I _O = -100μA	V _{CC} - 0.2	V _{CC}		V
		V _{CC} = 2.3V; V _I = V _{IH} or V _{IL} ; I _O = -4mA	V _{CC} - 0.4	V _{CC} - 0.11		
		V _{CC} = 2.3V; V _I = V _{IH} or V _{IL} ; I _O = -6mA	V _{CC} - 0.6	V _{CC} - 0.17		
		V _{CC} = 2.7V; V _I = V _{IH} or V _{IL} ; I _O = -4mA	V _{CC} - 0.5	V _{CC} - 0.09		
		V _{CC} = 2.7V; V _I = V _{IH} or V _{IL} ; I _O = -8mA	V _{CC} - 0.7	V _{CC} - 0.19		
		V _{CC} = 3.0V; V _I = V _{IH} or V _{IL} ; I _O = -6mA	V _{CC} - 0.6	V _{CC} - 0.13		
		V _{CC} = 3.0V; V _I = V _{IH} or V _{IL} ; I _O = -12mA	V _{CC} - 1.0	V _{CC} - 0.27		
V _{OL}	LOW level output voltage	V _{CC} = 2.3 to 3.6V; V _I = V _{IH} or V _{IL} ; I _O = 100μA		GND	0.20	V
		V _{CC} = 2.3V; V _I = V _{IH} or V _{IL} ; I _O = 4mA		0.07	0.40	
		V _{CC} = 2.3V; V _I = V _{IH} or V _{IL} ; I _O = 6mA		0.11	0.55	
		V _{CC} = 2.7V; V _I = V _{IH} or V _{IL} ; I _O = 4mA		0.06	0.40	
		V _{CC} = 2.7V; V _I = V _{IH} or V _{IL} ; I _O = 8mA		0.13	0.60	
		V _{CC} = 3.0V; V _I = V _{IH} or V _{IL} ; I _O = 6mA		0.09	0.55	
		V _{CC} = 3.0V; V _I = V _{IH} or V _{IL} ; I _O = 12mA		0.19	0.80	
I _I	Input leakage current	V _{CC} = 2.3 to 3.6V; V _I = V _{CC} or GND		0.1	5	μA
I _{OZ}	3-State output OFF-state current	V _{CC} = 2.3 to 3.6V; V _I = V _{IH} or V _{IL} ; V _O = V _{CC} or GND		0.1	10	μA
I _{CC}	Quiescent supply current	V _{CC} = 2.3 to 3.6V; V _I = V _{CC} or GND; I _O = 0		0.2	40	μA
ΔI _{CC}	Additional quiescent supply current	V _{CC} = 2.3V to 3.6V; V _I = V _{CC} - 0.6V; I _O = 0		150	750	μA
I _{BHL}	Bus hold LOW sustaining current	V _{CC} = 2.3V; V _I = 0.7V ²	45	-		μA
I _{BHH}	Bus hold HIGH sustaining current	V _{CC} = 2.3V; V _I = 1.7V ²	-45			μA
		V _{CC} = 3.0V; V _I = 2.0V ²	-75	-175		
I _{BHLO}	Bus hold LOW overdrive current	V _{CC} = 3.6V ²	500			μA
I _{BHHO}	Bus hold HIGH overdrive current	V _{CC} = 3.6V ²	-500			μA

NOTES:

- All typical values are at T_{amb} = 25°C.
- Valid for data inputs of bus hold parts.

20-bit buffer/line driver, non-inverting, with 30Ω termination resistors (3-State)

74ALVCH162827

AC CHARACTERISTICS FOR $V_{CC} = 2.5V \pm 0.2V$

GND = 0V; $t_r = t_f \leq 2.0ns$; $C_L = 30pF$

SYMBOL	PARAMETER	WAVEFORM	LIMITS			UNIT
			$V_{CC} = 2.5 \pm 0.2V$			
			MIN	TYP ¹	MAX	
t_{PHL}/t_{PLH}	Propagation delay nAn to nYn	1, 3	1.0	2.9	4.6	ns
t_{PZH}/t_{PZL}	3-State output enable time nOEn to nYn	2, 3	1.4	3.9	6.4	ns
t_{PHZ}/t_{PLZ}	3-State output disable time nOEn to nYn	2,3	1.7	2.2	5.9	ns

NOTE:1. All typical values are at $V_{CC} = 2.5V$ and $T_{amb} = 25^\circ C$.

AC CHARACTERISTICS FOR $V_{CC} = 3.0V \pm 0.3V$

GND = 0V; $t_r = t_f \leq 2.5ns$; $C_L = 50pF$

SYMBOL	PARAMETER	WAVEFORM	LIMITS			LIMITS		UNIT
			$V_{CC} = 3.3 \pm 0.3V$			$V_{CC} = 2.7V$		
			MIN	TYP ^{1, 2}	MAX	TYP ¹	MAX	
t_{PHL}/t_{PLH}	Propagation delay nAn to nYn	1, 3	1.5	2.9	4.2	3.1	4.7	ns
t_{PZH}/t_{PZL}	3-State output enable time nOEn to nYn	2, 3	1.6	3.7	5.4	4.4	6.5	ns
t_{PHZ}/t_{PLZ}	3-State output disable time nOEn to nYn	2, 3	1.8	3.0	4.7	3.2	5.2	ns

NOTES:1. All typical values are at V_{CC} $T_{amb} = 25^\circ C$.2. Typical value is measured at $V_{CC} = 3.3V$.

20-bit buffer/line driver, non-inverting, with 30Ω termination resistors (3-State)

74ALVCH162827

AC WAVEFORMS FOR $V_{CC} = 2.3V$ TO $2.7V$

$V_M = 0.5 V_{CC}$
 $V_X = V_{OL} + 0.15V$
 $V_Y = V_{OH} - 0.15V$
 V_{OL} and V_{OH} are the typical output voltage drop that occur with the output load.
 $V_I = V_{CC}$

AC WAVEFORMS FOR $V_{CC} = 3.0V$ TO $3.6V$ AND $V_{CC} = 2.7V$ RANGE

$V_M = 1.5 V$
 $V_X = V_{OL} + 0.3V$
 $V_Y = V_{OH} - 0.3V$
 V_{OL} and V_{OH} are the typical output voltage drop that occur with the output load.
 $V_I = 2.7V$

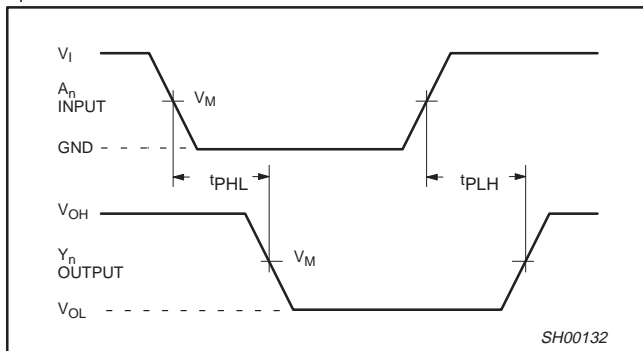

Waveform 1. Input (nAx) to Output (nYx) Propagation Delays

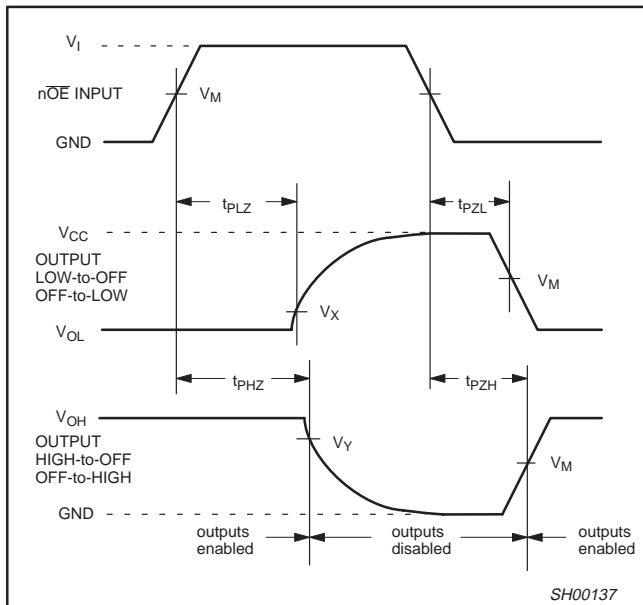

Waveform 2. 3-State Output Enable and Disable Times

TEST CIRCUIT AND WAVEFORM

Test Circuit for switching times

DEFINITIONS
 R_L = Load resistor
 C_L = Load capacitance includes jig and probe capacitance
 R_T = Termination resistance should be equal to Z_{OUT} of pulse generators.

SWITCH POSITION

TEST	S_1	V_{CC}	V_I
t_{PLH}/t_{PHL}	Open	< 2.7V	V_{CC}
t_{PLZ}/t_{PZL}	$2 * V_{CC}$	2.7-3.6V	2.7V
t_{PHZ}/t_{PZH}	GND		

SV00906

Waveform 3. Load circuitry for switching times

20-bit buffer/line driver, non-inverting, with 30Ω termination resistors (3-State)

74ALVCH162827

TSSOP56: plastic thin shrink small outline package; 56 leads; body width 6.1mm

SOT364-1

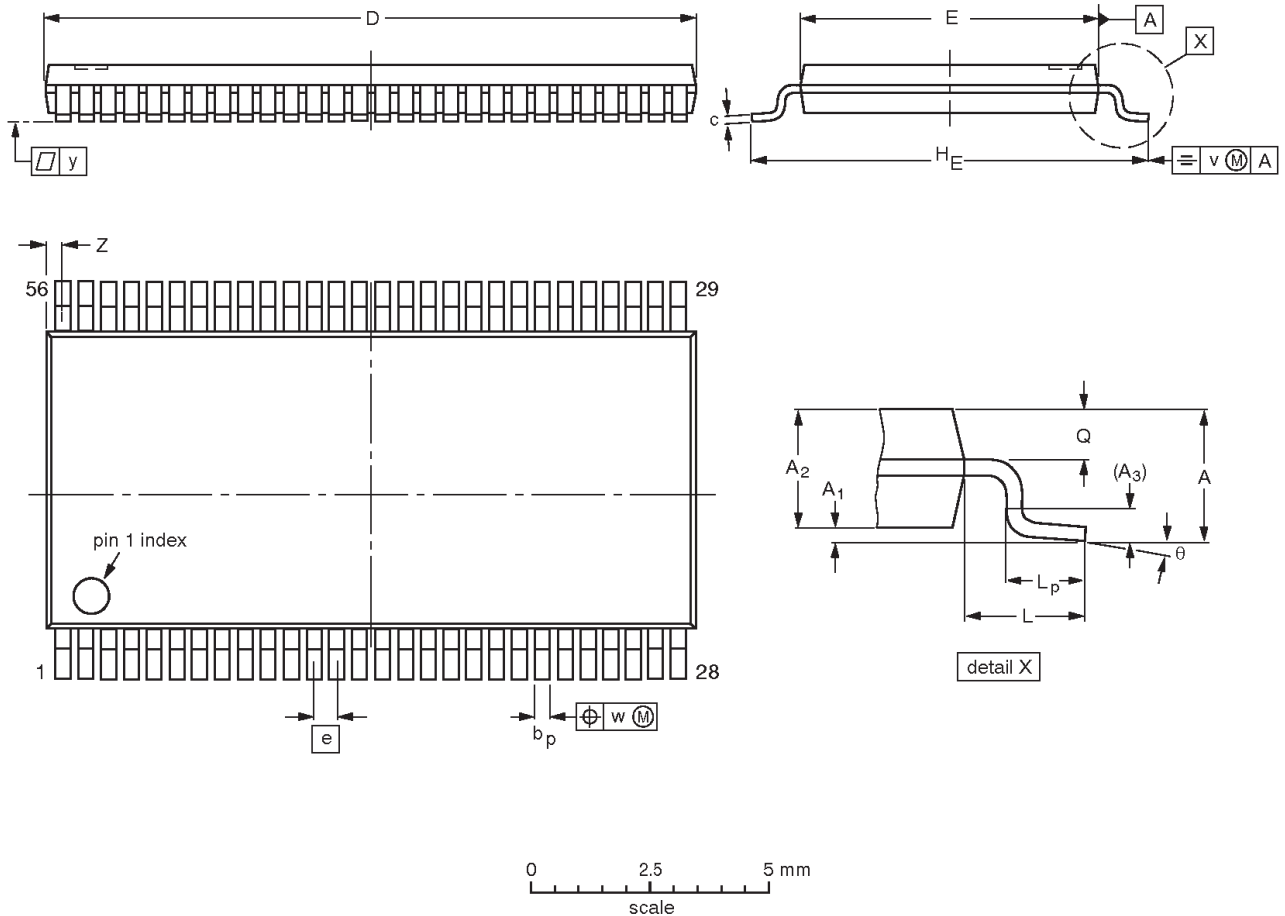

DIMENSIONS (mm are the original dimensions).

UNIT	A max.	A ₁	A ₂	A ₃	b _p	c	D ⁽¹⁾	E ⁽²⁾	e	H _E	L	L _p	Q	v	w	y	Z	θ
mm	1.2	0.15 0.05	1.05 0.85	0.25	0.28 0.17	0.2 0.1	14.1 13.9	6.2 6.0	0.5	8.3 7.9	1.0	0.8 0.4	0.50 0.35	0.25	0.08	0.1	0.5 0.1	8° 0°

Notes

1. Plastic or metal protrusions of 0.15 mm maximum per side are not included.
2. Plastic interlead protrusions of 0.25 mm maximum per side are not included.

OUTLINE VERSION	REFERENCES				EUROPEAN PROJECTION	ISSUE DATE
	IEC	JEDEC	EIAJ			
SOT364-1		MO-153EE				93-02-03 95-02-10

20-bit buffer/line driver, non-inverting, with 30Ω
termination resistors (3-State)

74ALVCH162827

NOTES

20-bit buffer/line driver, non-inverting, with 30Ω termination resistors (3-State)

74ALVCH162827

DEFINITIONS

Data Sheet Identification	Product Status	Definition
<i>Objective Specification</i>	Formative or in Design	This data sheet contains the design target or goal specifications for product development. Specifications may change in any manner without notice.
<i>Preliminary Specification</i>	Preproduction Product	This data sheet contains preliminary data, and supplementary data will be published at a later date. Philips Semiconductors reserves the right to make changes at any time without notice in order to improve design and supply the best possible product.
<i>Product Specification</i>	Full Production	This data sheet contains Final Specifications. Philips Semiconductors reserves the right to make changes at any time without notice, in order to improve design and supply the best possible product.

Philips Semiconductors and Philips Electronics North America Corporation reserve the right to make changes, without notice, in the products, including circuits, standard cells, and/or software, described or contained herein in order to improve design and/or performance. Philips Semiconductors assumes no responsibility or liability for the use of any of these products, conveys no license or title under any patent, copyright, or mask work right to these products, and makes no representations or warranties that these products are free from patent, copyright, or mask work right infringement, unless otherwise specified. Applications that are described herein for any of these products are for illustrative purposes only. Philips Semiconductors makes no representation or warranty that such applications will be suitable for the specified use without further testing or modification.

LIFE SUPPORT APPLICATIONS

Philips Semiconductors and Philips Electronics North America Corporation Products are not designed for use in life support appliances, devices, or systems where malfunction of a Philips Semiconductors and Philips Electronics North America Corporation Product can reasonably be expected to result in a personal injury. Philips Semiconductors and Philips Electronics North America Corporation customers using or selling Philips Semiconductors and Philips Electronics North America Corporation Products for use in such applications do so at their own risk and agree to fully indemnify Philips Semiconductors and Philips Electronics North America Corporation for any damages resulting from such improper use or sale.

Philips Semiconductors
811 East Arques Avenue
P.O. Box 3409
Sunnyvale, California 94088-3409
Telephone 800-234-7381

© Copyright Philips Electronics North America Corporation 1998
 All rights reserved. Printed in U.S.A.

Date of release: 06-98

Document order number:

9397-750-04603

Let's make things better.

Philips
Semiconductors



PHILIPS