

BFU910F

NPN wideband silicon germanium RF transistor

Rev. 2 — 16 January 2015

Product data sheet

1. Product profile

1.1 General description

NPN silicon germanium RF transistor for high speed, low noise applications in a plastic, 4-pin dual-emitter SOT343F package.

The BFU910F is suitable for small signal applications up to 20 GHz.

1.2 Features and benefits

- Low noise high gain microwave transistor
- Minimum noise figure (NF_{min}) = 0.65 dB at 12 GHz
- Maximum stable gain 14.2 dB at 12 GHz
- 90 GHz f_T SiGe technology

1.3 Applications

- K_U band DBS Low-Noise blocks

1.4 Quick reference data

Table 1. Quick reference data

$T_{amb} = 25\text{ °C}$ unless otherwise specified

Symbol	Parameter	Conditions	Min	Typ	Max	Unit
V_{CE}	collector-emitter voltage	$R_{BE} \leq 1\text{ M}\Omega$	-	2.0	3.0	V
I_C	collector current		-	10	15	mA
P_{tot}	total power dissipation	$T_{sp} \leq 90\text{ °C}$	[1]	-	300	mW
h_{FE}	DC current gain	$I_C = 6\text{ mA}; V_{CE} = 2\text{ V}$	-	1900	-	
C_{CBS}	collector-base capacitance	$V_{CB} = 2\text{ V}; f = 1\text{ MHz}$	-	35	-	fF
f_T	transition frequency	$I_C = 6\text{ mA}; V_{CE} = 2\text{ V}$	-	90	-	GHz
MSG	maximum stable gain	$I_C = 6\text{ mA}; V_{CE} = 2\text{ V};$ $f = 12\text{ GHz}$	-	14.2	-	dB
NF_{min}	minimum noise figure	$I_C = 6\text{ mA}; V_{CE} = 2\text{ V};$ $f = 12\text{ GHz}; \Gamma_S = \Gamma_{opt}$	-	0.65	-	dB
G_{ass}	associated gain	$I_C = 6\text{ mA}; V_{CE} = 2\text{ V};$ $f = 12\text{ GHz}; \Gamma_S = \Gamma_{opt}$	-	13.0	-	dB
$P_{L(1dB)}$	output power at 1 dB gain compression	$I_C = 10\text{ mA}; V_{CE} = 2\text{ V};$ $f = 12\text{ GHz}; Z_S = Z_L = 50\ \Omega$	-	2	-	dBm

[1] T_{sp} is the temperature at the solder point of the emitter lead.



2. Pinning information

Table 2. Discrete pinning

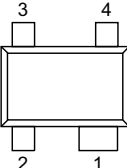
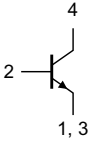
Pin	Description	Simplified outline	Graphic symbol
1	emitter		 <i>mbb159</i>
2	base		
3	emitter		
4	collector		

3. Ordering information

Table 3. Ordering information

Type number	Package		
	Name	Description	Version
BFU910F	-	plastic surface-mounted flat pack package; reverse pinning; 4 leads	SOT343F

4. Marking

Table 4. Marking

Type number	Marking	Description
BFU910F	F1*	* = t : made in Malaysia
		* = w : made in China

5. Design support

Table 5. Available design support

Download from the BFU910F product information page on <http://www.nxp.com>.

Support item	Available	Remarks
Device models for Agilent EEsof EDA ADS	Q1 2015	Based on Mextram device model.
SPICE model	Q1 2015	Based on Gummel-Poon device model.
S-parameters	yes	
Noise parameters	yes	
Solder pattern	yes	
Application notes	yes	

6. Limiting values

Table 6. Limiting values

In accordance with the Absolute Maximum Rating System (IEC 60134).

Symbol	Parameter	Conditions	Min	Max	Unit
V_{CB}	collector-base voltage	open emitter	-	9.5	V
V_{CE}	collector-emitter voltage	open base	-	2.0	V
		shorted base	-	9.5	V
V_{EB}	emitter-base voltage	open collector	-	1.5	V
T_{stg}	storage temperature		-65	+150	°C

7. Recommended operating conditions

Table 7. Characteristics

Symbol	Parameter	Conditions	Min	Typ	Max	Unit
V_{CE}	collector-emitter voltage	$R_{BE} \leq 1 \text{ M}\Omega$	-	2.0	3.0	V
V_{EB}	emitter-base voltage	open collector	-	-	1.0	V
I_C	collector current		-	-	15	mA
P_i	input power	$Z_S = 50 \Omega$	-	-	0	dBm
T_j	junction temperature		-40	-	+150	°C
P_{tot}	total power dissipation	$T_{sp} \leq 90 \text{ °C}$ [1]	-	-	300	mW

[1] T_{sp} is the temperature at the solder point of the emitter lead.

8. Thermal characteristics

Table 8. Thermal characteristics

Symbol	Parameter	Conditions	Typ	Unit
$R_{th(j-sp)}$	thermal resistance from junction to solder point		[1][2] 202	K/W

[1] T_{sp} is the temperature at the solder point of the collector lead.

T_{sp} has the following relation to the ambient temperature T_{amb} : $T_{sp} = T_{amb} + P \times R_{th(sp-amb)}$

with P the power dissipation and $R_{th(sp-amb)}$ the thermal resistance between the solder point and ambient.

$R_{th(sp-amb)}$ is determined by the heat transfer properties in the application.

The heat transfer properties are set by the application board materials, the board layout and the environment e.g. housing.

[2] Based on simulation.

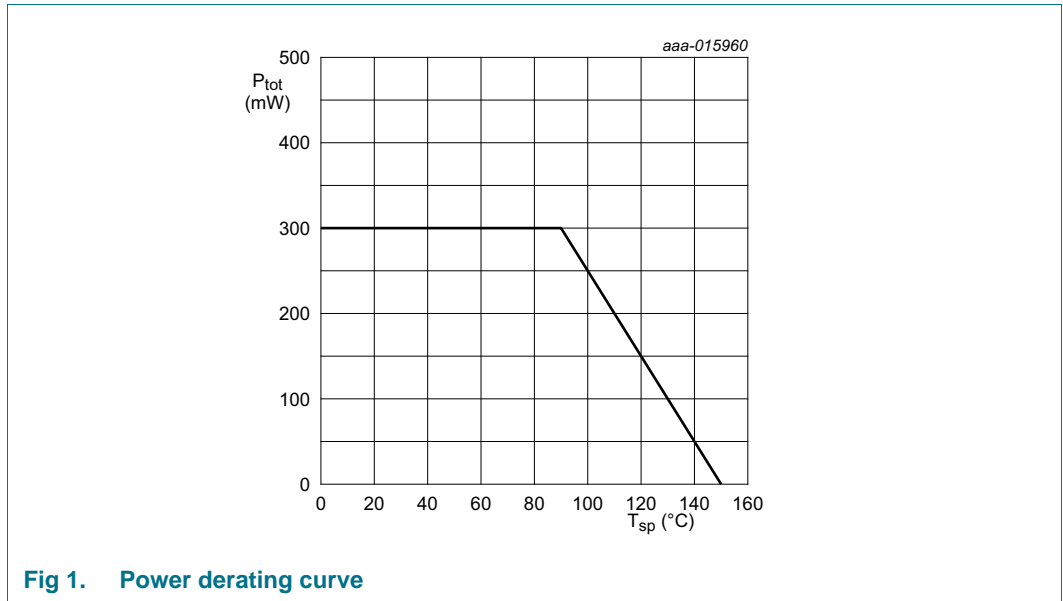

Fig 1. Power derating curve

9. Characteristics

Table 9. Characteristics

T_{amb} = 25 °C unless otherwise specified

Symbol	Parameter	Conditions	Min	Typ	Max	Unit
V _{(BR)CBO}	collector-base breakdown voltage	I _C = 10 μA; I _E = 0 μA	9.5	-	-	V
V _{(BR)CEO}	collector-emitter breakdown voltage	I _C = 10 μA; I _B = 0 μA	2.0	-	-	V
I _C	collector current		-	6	15	mA
h _{FE}	DC current gain	I _C = 1.5 mA; V _{CE} = 1.5 V	1200	2200	3300	
		I _C = 6 mA; V _{CE} = 2 V	-	1900	-	
C _{CEs}	collector-emitter capacitance	V _{CE} = 2 V; f = 1 MHz	-	215	-	fF
C _{EBS}	emitter-base capacitance	V _{EB} = 0.5 V; f = 1 MHz	-	300	-	fF
C _{CBS}	collector-base capacitance	V _{CB} = 2 V; f = 1 MHz	-	35	-	fF
f _T	transition frequency	I _C = 5 mA; V _{CE} = 2 V	-	90	-	GHz
MSG	maximum stable gain	f = 10.7 GHz; V _{CE} = 2 V				
		I _C = 6 mA	-	15.2	-	dB
		I _C = 10 mA	-	15.5	-	dB
		f = 12 GHz; V _{CE} = 2 V				
		I _C = 6 mA	-	14.2	-	dB
		I _C = 10 mA	-	14.5	-	dB
		f = 12.75 GHz; V _{CE} = 2 V				
		I _C = 6 mA	-	14.2	-	dB
I _C = 10 mA	-	14.5	-	dB		

Table 9. Characteristics ...continued
T_{amb} = 25 °C unless otherwise specified

Symbol	Parameter	Conditions	Min	Typ	Max	Unit
S ₂₁ ²	insertion power gain	f = 10.7 GHz; V _{CE} = 2 V				
		I _C = 6 mA	-	13.0	-	dB
		I _C = 10 mA	-	13.5	-	dB
		f = 12 GHz; V _{CE} = 2 V				
		I _C = 6 mA	-	12.0	-	dB
		I _C = 10 mA	-	12.5	-	dB
		f = 12.75 GHz; V _{CE} = 2 V				
		I _C = 10 mA	-	12.5	-	dB
NF _{min}	minimum noise figure	f = 10.7 GHz; V _{CE} = 2 V; Γ _S = Γ _{opt}				
		I _C = 6 mA	-	0.6	-	dB
		I _C = 10 mA	-	0.65	-	dB
		f = 12 GHz; V _{CE} = 2 V; Γ _S = Γ _{opt}				
		I _C = 6 mA	-	0.65	0.85	dB
		I _C = 10 mA	-	0.7	-	dB
		f = 12.75 GHz; V _{CE} = 2 V; Γ _S = Γ _{opt}				
		I _C = 10 mA	-	0.7	-	dB
G _{ass}	associated gain	f = 10.7 GHz; V _{CE} = 2 V; Γ _S = Γ _{opt}				
		I _C = 6 mA	-	13.5	-	dB
		I _C = 10 mA	-	14.0	-	dB
		f = 12 GHz; V _{CE} = 2 V; Γ _S = Γ _{opt}				
		I _C = 6 mA	-	13.0	-	dB
		I _C = 10 mA	-	13.5	-	dB
		f = 12.75 GHz; V _{CE} = 2 V; Γ _S = Γ _{opt}				
		I _C = 10 mA	-	13.5	-	dB
P _{L(1dB)}	output power at 1 dB gain compression	f = 12 GHz; V _{CE} = 2 V; Z _S = Z _L = 50 Ω; I _C = 10 mA	-	2	-	dBm
IP _{3o}	output third-order intercept point	f ₁ = 12.000 GHz; f ₂ = 12.025 GHz; V _{CE} = 2 V; Z _S = Z _L = 50 Ω; I _C = 10 mA	-	12.5	-	dBm

9.1 Graphs

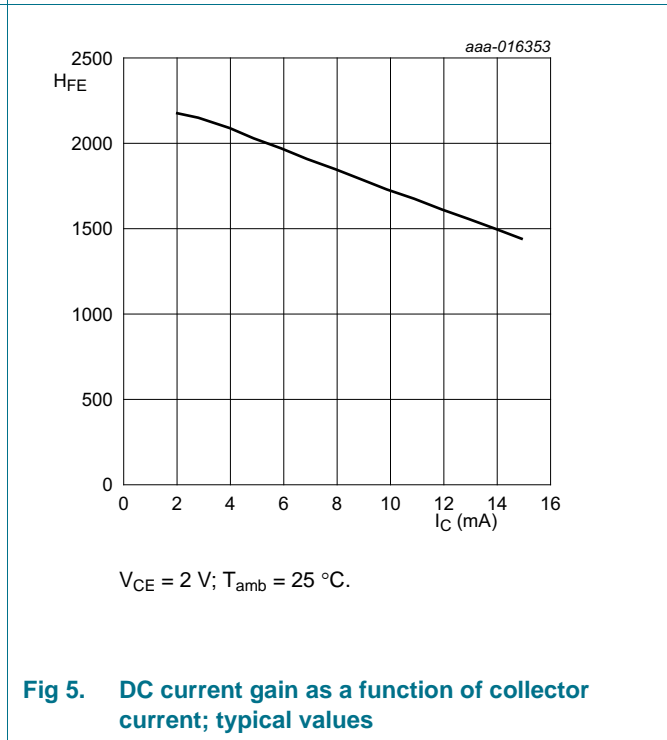
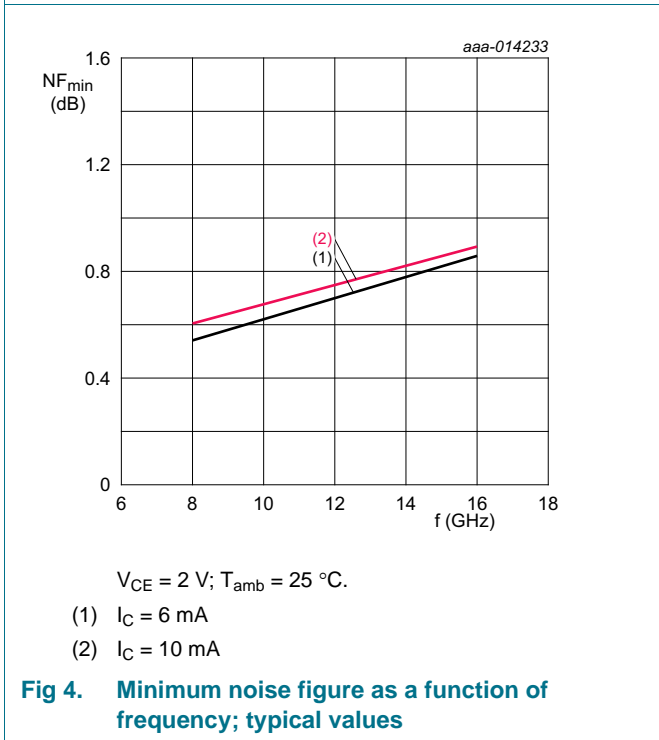
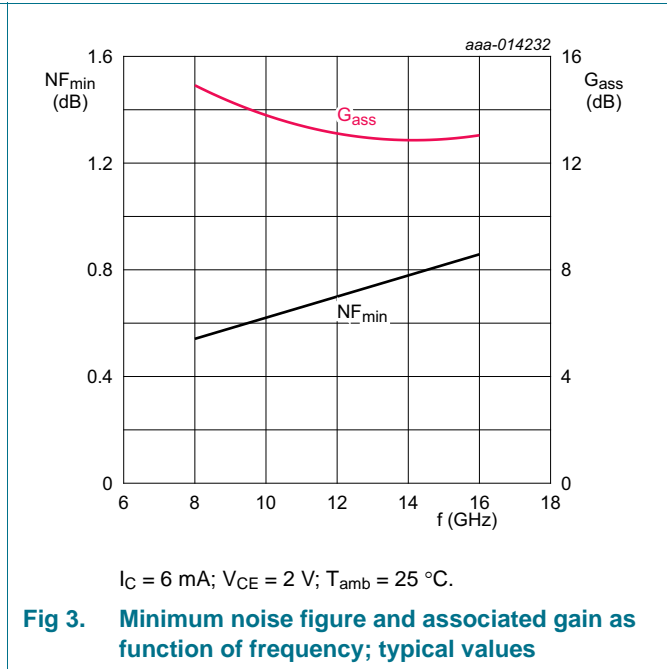
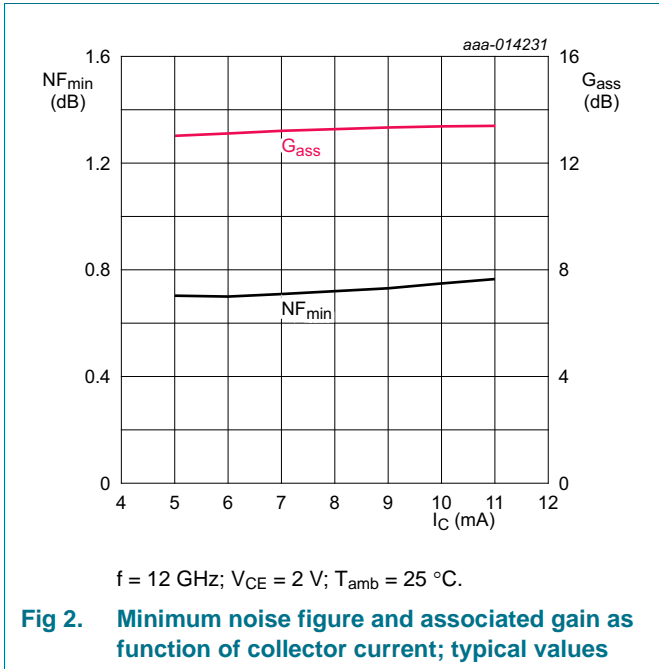

10. Package outline

Plastic surface-mounted flat pack package; reverse pinning; 4 leads

SOT343F

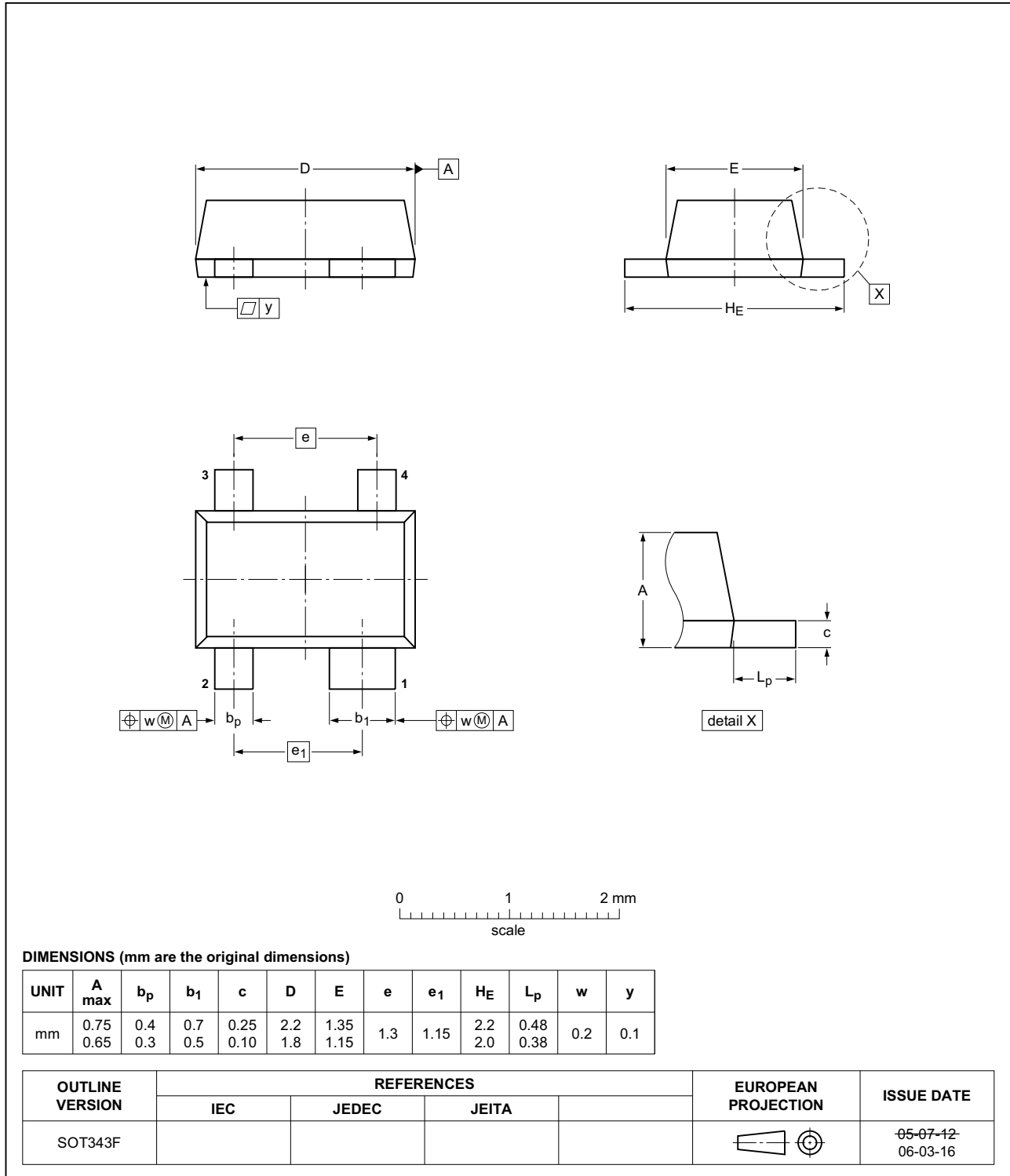

Fig 6. Package outline SOT343F

11. Handling information

CAUTION



This device is sensitive to ElectroStatic Discharge (ESD). Observe precautions for handling electrostatic sensitive devices.

Such precautions are described in the *ANSI/ESD S20.20*, *IEC/ST 61340-5*, *JESD625-A* or equivalent standards.

12. Abbreviations

Table 10. Abbreviations

Acronym	Description
DBS	Direct Broadcast Satellite
K _u band	K-under band
NPN	Negative-Positive-Negative
SiGe	Silicon Germanium

13. Revision history

Table 11. Revision history

Document ID	Release date	Data sheet status	Change notice	Supersedes
BFU910F v.2	20150116	Product data sheet	-	BFU910F v.1
Modifications	<ul style="list-style-type: none"> The status of this document has been changed to "Product data sheet". The title has been changed to "NPN wideband silicon germanium RF transistor". Section 1.1 on page 1: the wording of this section has been changed. Table 1 on page 1: Some changes have been made. Table 6 on page 3: The maximum value for $V_{CE,open\ base}$ has been changed. Table 7 on page 3: The typical value for V_{CE} has been changed. Table 9 on page 4: the conditions for $V_{(BR)CBO}$ and $V_{(BR)CEO}$ have been changed. Figure 5 on page 6: the figure has been added. 			
BFU910F v.1	20141128	Preliminary data sheet	-	-

14. Legal information

14.1 Data sheet status

Document status ^{[1][2]}	Product status ^[3]	Definition
Objective [short] data sheet	Development	This document contains data from the objective specification for product development.
Preliminary [short] data sheet	Qualification	This document contains data from the preliminary specification.
Product [short] data sheet	Production	This document contains the product specification.

[1] Please consult the most recently issued document before initiating or completing a design.

[2] The term 'short data sheet' is explained in section "Definitions".

[3] The product status of device(s) described in this document may have changed since this document was published and may differ in case of multiple devices. The latest product status information is available on the Internet at URL <http://www.nxp.com>.

14.2 Definitions

Draft — The document is a draft version only. The content is still under internal review and subject to formal approval, which may result in modifications or additions. NXP Semiconductors does not give any representations or warranties as to the accuracy or completeness of information included herein and shall have no liability for the consequences of use of such information.

Short data sheet — A short data sheet is an extract from a full data sheet with the same product type number(s) and title. A short data sheet is intended for quick reference only and should not be relied upon to contain detailed and full information. For detailed and full information see the relevant full data sheet, which is available on request via the local NXP Semiconductors sales office. In case of any inconsistency or conflict with the short data sheet, the full data sheet shall prevail.

Product specification — The information and data provided in a Product data sheet shall define the specification of the product as agreed between NXP Semiconductors and its customer, unless NXP Semiconductors and customer have explicitly agreed otherwise in writing. In no event however, shall an agreement be valid in which the NXP Semiconductors product is deemed to offer functions and qualities beyond those described in the Product data sheet.

14.3 Disclaimers

Limited warranty and liability — Information in this document is believed to be accurate and reliable. However, NXP Semiconductors does not give any representations or warranties, expressed or implied, as to the accuracy or completeness of such information and shall have no liability for the consequences of use of such information. NXP Semiconductors takes no responsibility for the content in this document if provided by an information source outside of NXP Semiconductors.

In no event shall NXP Semiconductors be liable for any indirect, incidental, punitive, special or consequential damages (including - without limitation - lost profits, lost savings, business interruption, costs related to the removal or replacement of any products or rework charges) whether or not such damages are based on tort (including negligence), warranty, breach of contract or any other legal theory.

Notwithstanding any damages that customer might incur for any reason whatsoever, NXP Semiconductors' aggregate and cumulative liability towards customer for the products described herein shall be limited in accordance with the *Terms and conditions of commercial sale* of NXP Semiconductors.

Right to make changes — NXP Semiconductors reserves the right to make changes to information published in this document, including without limitation specifications and product descriptions, at any time and without notice. This document supersedes and replaces all information supplied prior to the publication hereof.

Suitability for use — NXP Semiconductors products are not designed, authorized or warranted to be suitable for use in life support, life-critical or safety-critical systems or equipment, nor in applications where failure or malfunction of an NXP Semiconductors product can reasonably be expected to result in personal injury, death or severe property or environmental damage. NXP Semiconductors and its suppliers accept no liability for inclusion and/or use of NXP Semiconductors products in such equipment or applications and therefore such inclusion and/or use is at the customer's own risk.

Applications — Applications that are described herein for any of these products are for illustrative purposes only. NXP Semiconductors makes no representation or warranty that such applications will be suitable for the specified use without further testing or modification.

Customers are responsible for the design and operation of their applications and products using NXP Semiconductors products, and NXP Semiconductors accepts no liability for any assistance with applications or customer product design. It is customer's sole responsibility to determine whether the NXP Semiconductors product is suitable and fit for the customer's applications and products planned, as well as for the planned application and use of customer's third party customer(s). Customers should provide appropriate design and operating safeguards to minimize the risks associated with their applications and products.

NXP Semiconductors does not accept any liability related to any default, damage, costs or problem which is based on any weakness or default in the customer's applications or products, or the application or use by customer's third party customer(s). Customer is responsible for doing all necessary testing for the customer's applications and products using NXP Semiconductors products in order to avoid a default of the applications and the products or of the application or use by customer's third party customer(s). NXP does not accept any liability in this respect.

Limiting values — Stress above one or more limiting values (as defined in the Absolute Maximum Ratings System of IEC 60134) will cause permanent damage to the device. Limiting values are stress ratings only and (proper) operation of the device at these or any other conditions above those given in the Recommended operating conditions section (if present) or the Characteristics sections of this document is not warranted. Constant or repeated exposure to limiting values will permanently and irreversibly affect the quality and reliability of the device.

Terms and conditions of commercial sale — NXP Semiconductors products are sold subject to the general terms and conditions of commercial sale, as published at <http://www.nxp.com/profile/terms>, unless otherwise agreed in a valid written individual agreement. In case an individual agreement is concluded only the terms and conditions of the respective agreement shall apply. NXP Semiconductors hereby expressly objects to applying the customer's general terms and conditions with regard to the purchase of NXP Semiconductors products by customer.

No offer to sell or license — Nothing in this document may be interpreted or construed as an offer to sell products that is open for acceptance or the grant, conveyance or implication of any license under any copyrights, patents or other industrial or intellectual property rights.

Export control — This document as well as the item(s) described herein may be subject to export control regulations. Export might require a prior authorization from competent authorities.

Quick reference data — The Quick reference data is an extract of the product data given in the Limiting values and Characteristics sections of this document, and as such is not complete, exhaustive or legally binding.

Non-automotive qualified products — Unless this data sheet expressly states that this specific NXP Semiconductors product is automotive qualified, the product is not suitable for automotive use. It is neither qualified nor tested in accordance with automotive testing or application requirements. NXP Semiconductors accepts no liability for inclusion and/or use of non-automotive qualified products in automotive equipment or applications.

In the event that customer uses the product for design-in and use in automotive applications to automotive specifications and standards, customer (a) shall use the product without NXP Semiconductors' warranty of the

product for such automotive applications, use and specifications, and (b) whenever customer uses the product for automotive applications beyond NXP Semiconductors' specifications such use shall be solely at customer's own risk, and (c) customer fully indemnifies NXP Semiconductors for any liability, damages or failed product claims resulting from customer design and use of the product for automotive applications beyond NXP Semiconductors' standard warranty and NXP Semiconductors' product specifications.

Translations — A non-English (translated) version of a document is for reference only. The English version shall prevail in case of any discrepancy between the translated and English versions.

14.4 Trademarks

Notice: All referenced brands, product names, service names and trademarks are the property of their respective owners.

15. Contact information

For more information, please visit: <http://www.nxp.com>

For sales office addresses, please send an email to: salesaddresses@nxp.com

16. Contents

1	Product profile	1
1.1	General description	1
1.2	Features and benefits	1
1.3	Applications	1
1.4	Quick reference data	1
2	Pinning information	2
3	Ordering information	2
4	Marking	2
5	Design support	2
6	Limiting values	3
7	Recommended operating conditions	3
8	Thermal characteristics	3
9	Characteristics	4
9.1	Graphs	6
10	Package outline	7
11	Handling information	8
12	Abbreviations	8
13	Revision history	8
14	Legal information	9
14.1	Data sheet status	9
14.2	Definitions	9
14.3	Disclaimers	9
14.4	Trademarks	10
15	Contact information	10
16	Contents	11

Please be aware that important notices concerning this document and the product(s) described herein, have been included in section 'Legal information'.

© NXP B.V. 2015.

All rights reserved.

For more information, please visit: <http://www.nxp.com>

For sales office addresses, please send an email to: salesaddresses@nxp.com

Date of release: 16 January 2015

Document identifier: BFU910F