

BLL1214-35

L-band radar LDMOS driver transistor

Rev. 2 — 1 September 2015

AMPLEON

Product data sheet

IMPORTANT NOTICE

Dear customer,

As of December 7th, 2015 BL RF Power of NXP Semiconductors will operate as an independent company under the new trade name Ampleon, which will be used in future data sheets together with new contact details.

In data sheets, where the previous Philips references is mentioned, please use the new links as shown below.

<http://www.philips.semiconductors.com> use <http://www.ampleon.com>

<http://www.semiconductors.philips.com> use <http://www.ampleon.com> (Internet)

sales.addresses@www.semiconductors.philips.com use
<http://www.ampleon.com/sales>

The copyright notice at the bottom of each page (or elsewhere in the document, depending on the version)

- © Koninklijke Philips Electronics N.V. (year). All rights reserved -
is replaced with:

- © Ampleon B.V. (year). All rights reserved. -

If you have any questions related to the data sheet, please contact our nearest sales office (details via <http://www.ampleon.com/sales>).

Thank you for your cooperation and understanding,

Ampleon

L-band radar LDMOS driver transistor

BLL1214-35

FEATURES

- High power gain
- Easy power control
- Excellent ruggedness
- Source on mounting base eliminates DC isolators, reducing common mode inductance.

APPLICATIONS

- L-band radar applications in the 1200 to 1400 MHz frequency range.

DESCRIPTION

Silicon N-channel enhancement mode lateral D-MOS transistor encapsulated in a 2-lead flange package (SOT467C) with a ceramic cap. The common source is connected to the flange.

PINNING - SOT467C

PIN	DESCRIPTION
1	drain
2	gate
3	source, connected to flange

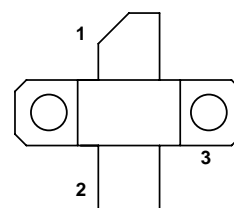

Top view MBK584

Fig.1 Simplified outline.

QUICK REFERENCE DATA

RF performance at $T_h = 25\text{ °C}$ in a common source test circuit.

MODE OF OPERATION	f (MHz)	V_{DS} (V)	P_L (W)	G_p (dB)	η_D (%)
Pulsed class-AB; $t = 1\text{ ms}$; $\delta = 10\%$	1200 to 1400	36	35	>13	>43

LIMITING VALUES

In accordance with the Absolute Maximum Rating System (IEC 60134).

SYMBOL	PARAMETER	CONDITIONS	MIN.	MAX.	UNIT
V_{DS}	drain-source voltage		–	75	V
V_{GS}	gate-source voltage		–	± 15	V
P_{tot}	total power dissipation	under RF conditions; $T_h \leq 25\text{ °C}$	–	110	W
T_{stg}	storage temperature		–65	+150	°C
T_j	junction temperature		–	200	°C

L-band radar LDMOS driver transistor

BLL1214-35

THERMAL CHARACTERISTICS

SYMBOL	PARAMETER	CONDITIONS	VALUE	UNIT
$Z_{th\ j-h}$	thermal impedance from junction to heatsink	$T_h = 25\text{ °C}$; note 1	1.1	K/W

Note

1. Thermal resistance is determined under RF operating conditions; $t_p = 1\text{ ms}$, $\delta = 10\%$.

CHARACTERISTICS

$T_j = 25\text{ °C}$ unless otherwise specified.

SYMBOL	PARAMETER	CONDITIONS	MIN.	TYP.	MAX.	UNIT
$V_{(BR)DSS}$	drain-source breakdown voltage	$V_{GS} = 0$; $I_D = 0.7\text{ mA}$	75	–	–	V
V_{GSth}	gate-source threshold voltage	$V_{DS} = 10\text{ V}$; $I_D = 70\text{ mA}$	4.5	–	5.5	V
I_{DSS}	drain-source leakage current	$V_{GS} = 0$; $V_{DS} = 36\text{ V}$	–	–	10	μA
I_{DSX}	on-state drain current	$V_{GS} = V_{GSth} + 9\text{ V}$; $V_{DS} = 10\text{ V}$	10	–	–	A
I_{GSS}	gate leakage current	$V_{GS} = \pm 20\text{ V}$; $V_{DS} = 0$	–	–	125	nA
g_{fs}	forward transconductance	$V_{DS} = 10\text{ V}$; $I_D = 2.5\text{ A}$	–	2	–	S
R_{DSon}	drain-source on-state resistance	$V_{GS} = 10\text{ V}$; $I_D = 2.5\text{ A}$	–	300	–	$\text{m}\Omega$

APPLICATION INFORMATION

RF performance in a common source class-AB circuit. $T_h = 25\text{ °C}$; $Z_{th\ mb-h} = 0.65\text{ K/W}$, unless otherwise specified.

MODE OF OPERATION	f (MHz)	V_{DS} (V)	I_{DQ} (mA)	P_L (W)	G_p (dB)	η_D (%)
Pulsed class-AB; $t = 1\text{ ms}$; $\delta = 10\%$	1200 to 1400	36	50	35	>13	>43

Ruggedness in class-AB operation

The BLL1214-35 is capable of withstanding a load mismatch corresponding to $VSWR = 5 : 1$ through all phases under the following conditions: $V_{DS} = 36\text{ V}$; frequency from 1200 MHz to 1400 MHz at rated load power.

Typical impedance

FREQUENCY (GHZ)	Z_s (Ω)	Z_L (Ω)
1.20	$6.48 - j\ 3.9$	$1.95 + j\ 3.27$
1.25	$3.88 - j\ 3.2$	$1.90 + j\ 2.57$
1.30	$3.28 - j\ 2.4$	$2.01 + j\ 2.27$
1.35	$2.55 - j\ 1.48$	$2.20 + j\ 2.26$
1.40	$1.69 - j\ 0.51$	$1.72 + j\ 2.35$

L-band radar LDMOS driver transistor

BLL1214-35

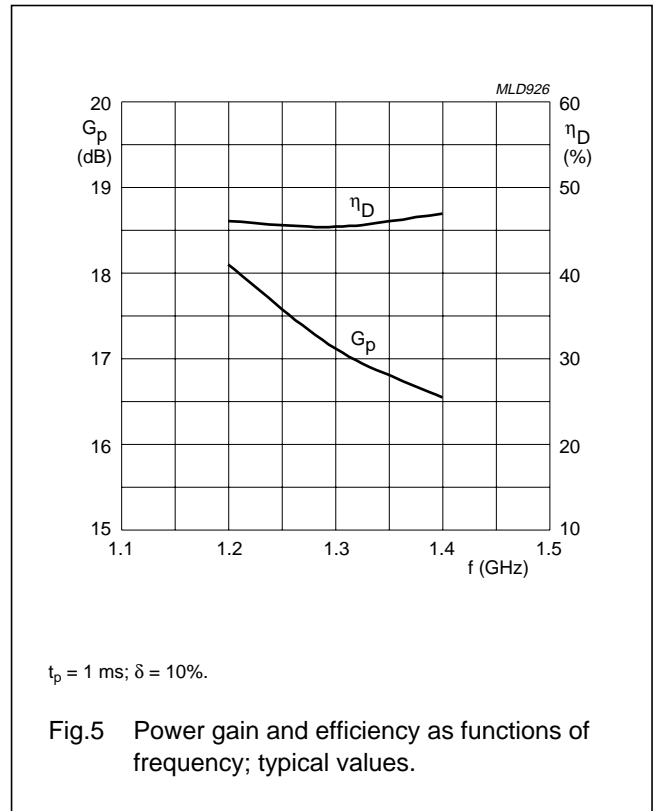
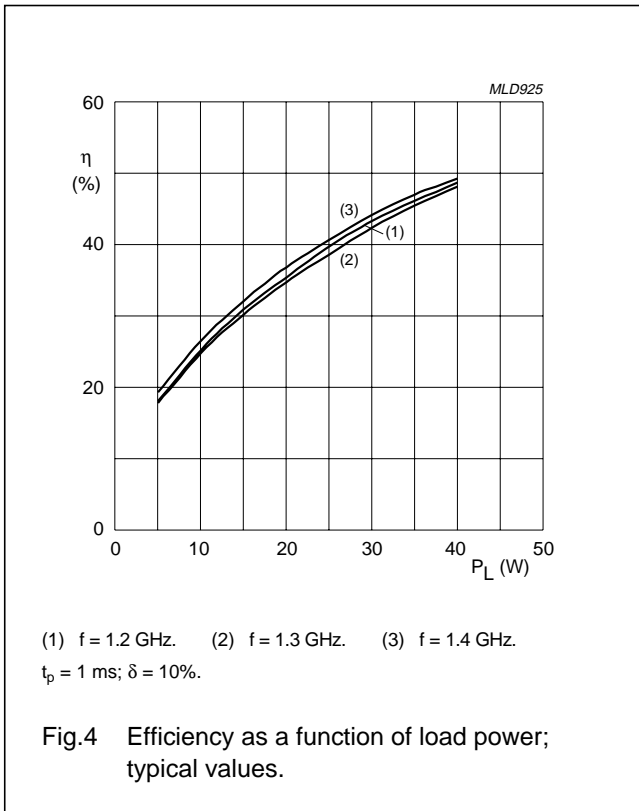
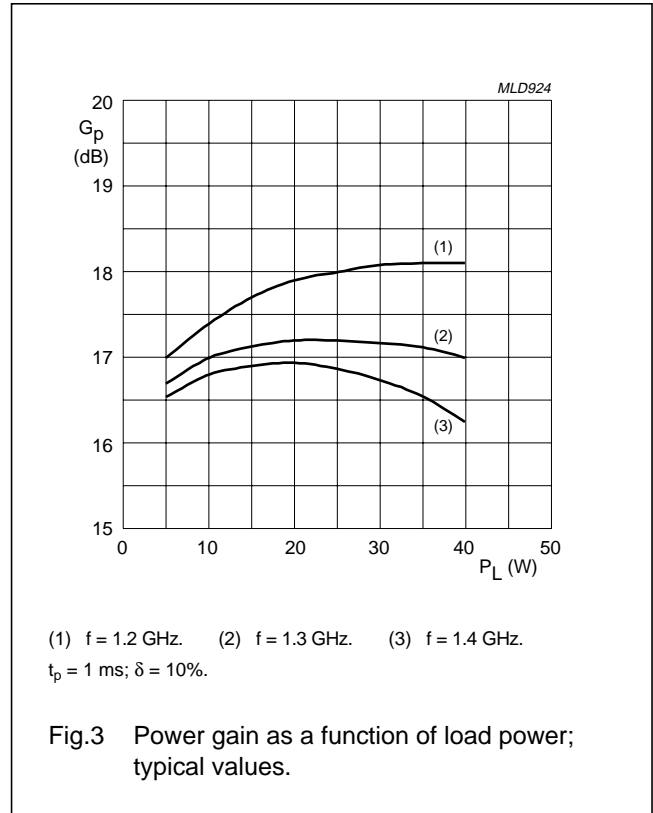
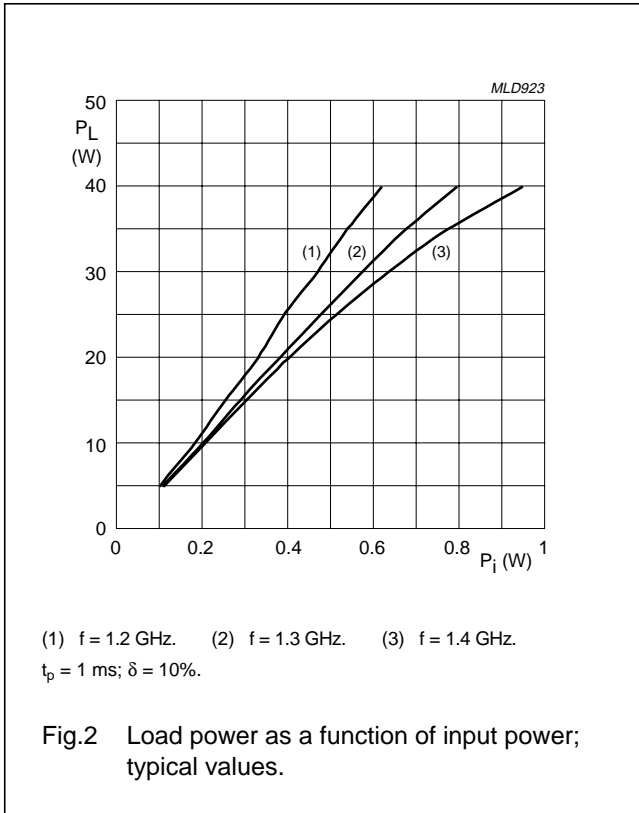

L-band radar LDMOS driver transistor

BLL1214-35

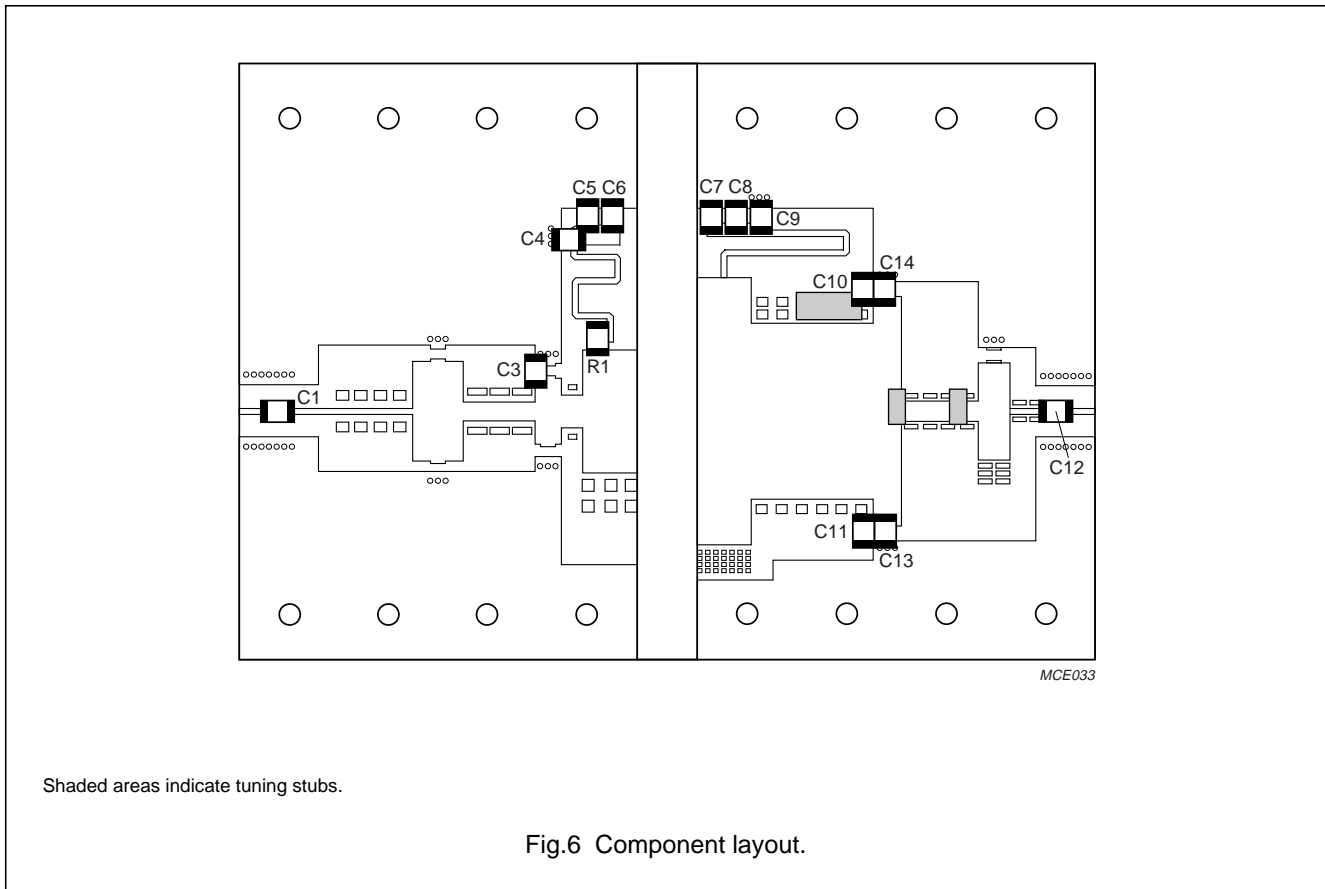

List of components (see Fig.6)

COMPONENT	DESCRIPTION	VALUE	CATALOGUE NO.
C1, C12	capacitor	51 pF	ATC100A
C3	capacitor	6.8 pF	ATC100A
C4, C9	capacitor	47 pF	ATC100A
C6, C7	capacitor	4.7 μ F/50 V	475 50k 952
C5, C8	capacitor	2.3 nF	ATC100B
C10	capacitor	2.7 pF	ATC100A
C11	capacitor	1.0 pF	ATC100A
C13, C14	capacitor	1.5 pF	ATC100A
R1	chip resistor	82 Ω	

L-band radar LDMOS driver transistor

BLL1214-35

PACKAGE OUTLINE

Flanged LDMOST ceramic package; 2 mounting holes; 2 leads

SOT467C

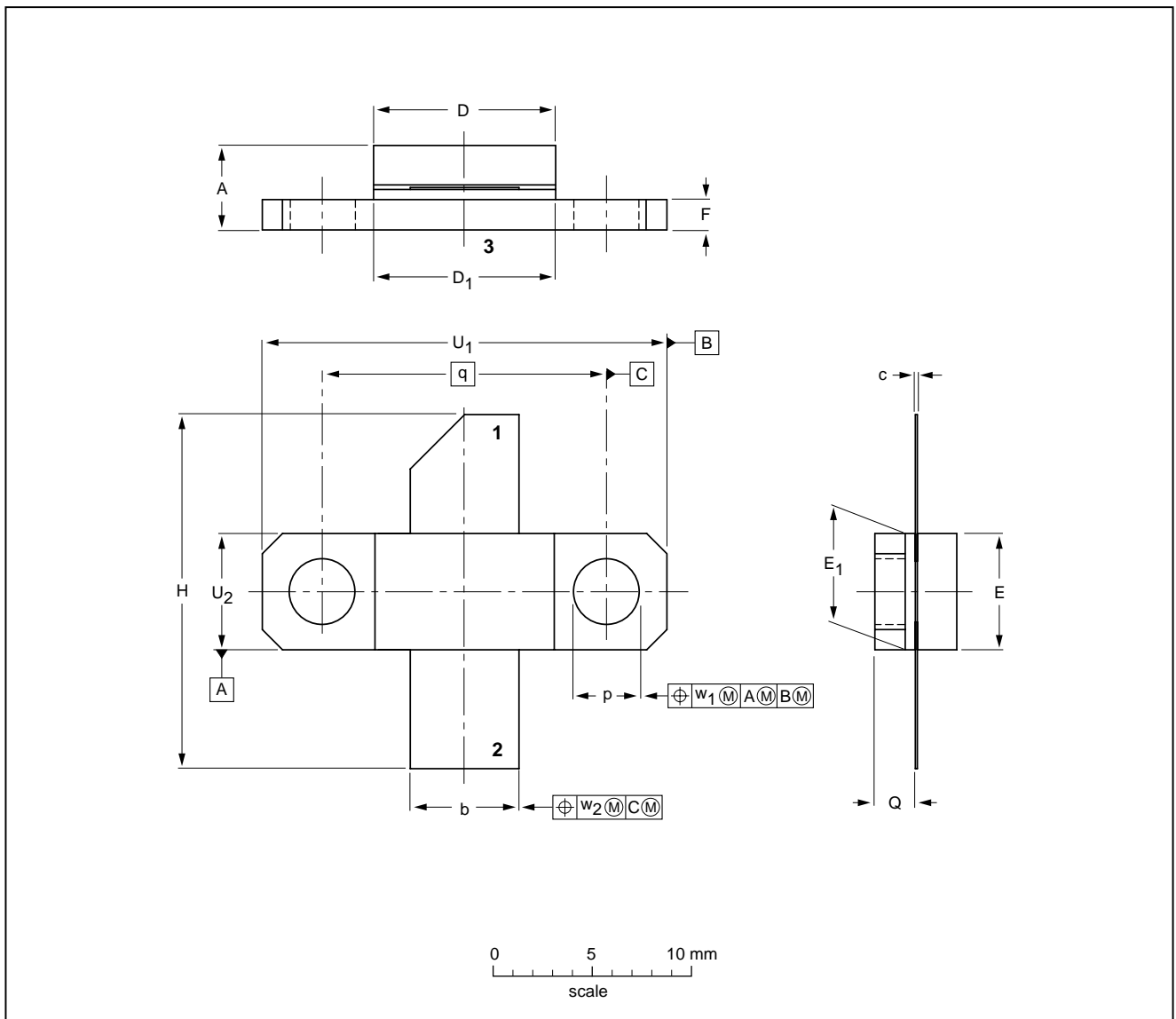

DIMENSIONS (millimetre dimensions are derived from the original inch dimensions)

UNIT	A	b	c	D	D ₁	E	E ₁	F	H	p	Q	q	U ₁	U ₂	w ₁	w ₂
mm	4.67 3.94	5.59 5.33	0.15 0.10	9.25 9.04	9.27 9.02	5.92 5.77	5.97 5.72	1.65 1.40	18.54 17.02	3.43 3.18	2.21 1.96	14.27	20.45 20.19	5.97 5.72	0.25	0.51
inch	0.184 0.155	0.220 0.210	0.006 0.004	0.364 0.356	0.365 0.355	0.233 0.227	0.235 0.225	0.065 0.055	0.73 0.67	0.135 0.125	0.087 0.077	0.562	0.805 0.795	0.235 0.225	0.010	0.020

OUTLINE VERSION	REFERENCES				EUROPEAN PROJECTION	ISSUE DATE
	IEC	JEDEC	EIAJ			
SOT467C						99-12-06 99-12-28

L-band radar LDMOS driver transistor

BLL1214-35

DATA SHEET STATUS

DATA SHEET STATUS ⁽¹⁾	PRODUCT STATUS ⁽²⁾	DEFINITIONS
Objective data	Development	This data sheet contains data from the objective specification for product development. Philips Semiconductors reserves the right to change the specification in any manner without notice.
Preliminary data	Qualification	This data sheet contains data from the preliminary specification. Supplementary data will be published at a later date. Philips Semiconductors reserves the right to change the specification without notice, in order to improve the design and supply the best possible product.
Product data	Production	This data sheet contains data from the product specification. Philips Semiconductors reserves the right to make changes at any time in order to improve the design, manufacturing and supply. Changes will be communicated according to the Customer Product/Process Change Notification (CPCN) procedure SNW-SQ-650A.

Notes

1. Please consult the most recently issued data sheet before initiating or completing a design.
2. The product status of the device(s) described in this data sheet may have changed since this data sheet was published. The latest information is available on the Internet at URL <http://www.semiconductors.philips.com>.

DEFINITIONS

Short-form specification — The data in a short-form specification is extracted from a full data sheet with the same type number and title. For detailed information see the relevant data sheet or data handbook.

Limiting values definition — Limiting values given are in accordance with the Absolute Maximum Rating System (IEC 60134). Stress above one or more of the limiting values may cause permanent damage to the device. These are stress ratings only and operation of the device at these or at any other conditions above those given in the Characteristics sections of the specification is not implied. Exposure to limiting values for extended periods may affect device reliability.

Application information — Applications that are described herein for any of these products are for illustrative purposes only. Philips Semiconductors make no representation or warranty that such applications will be suitable for the specified use without further testing or modification.

DISCLAIMERS

Life support applications — These products are not designed for use in life support appliances, devices, or systems where malfunction of these products can reasonably be expected to result in personal injury. Philips Semiconductors customers using or selling these products for use in such applications do so at their own risk and agree to fully indemnify Philips Semiconductors for any damages resulting from such application.

Right to make changes — Philips Semiconductors reserves the right to make changes, without notice, in the products, including circuits, standard cells, and/or software, described or contained herein in order to improve design and/or performance. Philips Semiconductors assumes no responsibility or liability for the use of any of these products, conveys no licence or title under any patent, copyright, or mask work right to these products, and makes no representations or warranties that these products are free from patent, copyright, or mask work right infringement, unless otherwise specified.

CAUTION

This product is supplied in anti-static packing to prevent damage caused by electrostatic discharge during transport and handling. For further information, refer to Philips specs.: SNW-EQ-608, SNW-FQ-302A and SNW-FQ-302B.

Philips Semiconductors – a worldwide company

Contact information

For additional information please visit <http://www.semiconductors.philips.com>. Fax: +31 40 27 24825

For sales offices addresses send e-mail to: sales.addresses@www.semiconductors.philips.com.

© Koninklijke Philips Electronics N.V. 2002

SCA74

All rights are reserved. Reproduction in whole or in part is prohibited without the prior written consent of the copyright owner.

The information presented in this document does not form part of any quotation or contract, is believed to be accurate and reliable and may be changed without notice. No liability will be accepted by the publisher for any consequence of its use. Publication thereof does not convey nor imply any license under patent- or other industrial or intellectual property rights.

Printed in The Netherlands

613524/01/pp8

Date of release: 2002 Sep 27

Document order number: 9397 750 09541

Let's make things better.

**Philips
Semiconductors**



PHILIPS