

BLF145

HF power MOS transistor

Rev. 5 — 1 September 2015

AMPLEON

Product data sheet

IMPORTANT NOTICE

Dear customer,

As of December 7th, 2015 BL RF Power of NXP Semiconductors will operate as an independent company under the new trade name Ampleon, which will be used in future data sheets together with new contact details.

In data sheets, where the previous Philips references is mentioned, please use the new links as shown below.

<http://www.philips.semiconductors.com> use <http://www.ampleon.com>

<http://www.semiconductors.philips.com> use <http://www.ampleon.com> (Internet)

sales.addresses@www.semiconductors.philips.com use
<http://www.ampleon.com/sales>

The copyright notice at the bottom of each page (or elsewhere in the document, depending on the version)

- © Koninklijke Philips Electronics N.V. (year). All rights reserved -
is replaced with:

- © Ampleon B.V. (year). All rights reserved. -

If you have any questions related to the data sheet, please contact our nearest sales office (details via <http://www.ampleon.com/sales>).

Thank you for your cooperation and understanding,

Ampleon

HF power MOS transistor

BLF145

FEATURES

- High power gain
- Low noise figure
- Good thermal stability
- Withstands full load mismatch.

DESCRIPTION

Silicon N-channel enhancement mode vertical D-MOS transistor designed for SSB transmitter applications in the HF frequency range. The transistor is encapsulated in a 4-lead, SOT123A flange package, with a ceramic cap. All leads are isolated from the flange. Matched gate-source voltage (V_{GS}) groups are available on request.

PINNING - SOT123A

PIN	DESCRIPTION
1	drain
2	source
3	gate
4	source

PIN CONFIGURATION

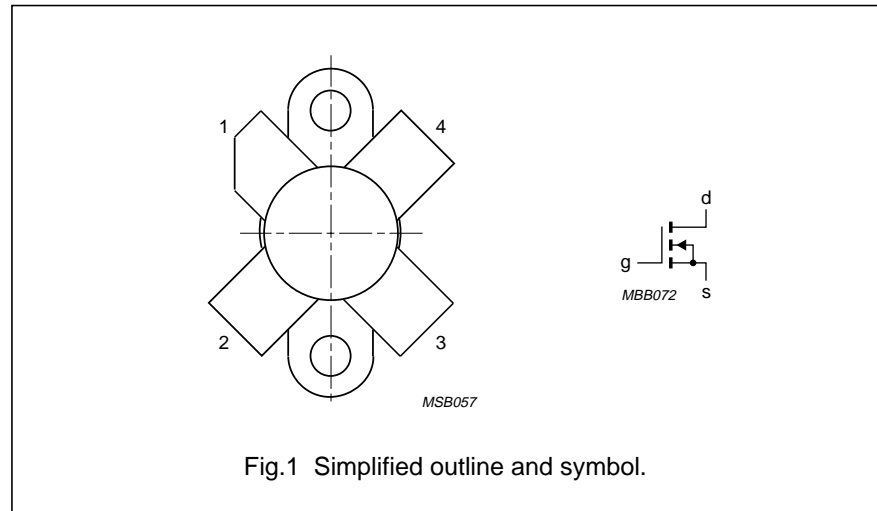

CAUTION

This product is supplied in anti-static packing to prevent damage caused by electrostatic discharge during transport and handling. For further information, refer to Philips specs.: SNW-EQ-608, SNW-FQ-302A, and SNW-FQ-302B.

WARNING

Product and environmental safety - toxic materials

This product contains beryllium oxide. The product is entirely safe provided that the BeO disc is not damaged. All persons who handle, use or dispose of this product should be aware of its nature and of the necessary safety precautions. After use, dispose of as chemical or special waste according to the regulations applying at the location of the user. It must never be thrown out with the general or domestic waste.

QUICK REFERENCE DATA

RF performance at $T_h = 25^\circ\text{C}$ in a common source test circuit.

MODE OF OPERATION	f (MHz)	V_{DS} (V)	I_D (A)	P_L (W)	G_p (dB)	η_D (%) ⁽¹⁾	d_3 (dB)
SSB, class-A	28	28	1.3	8 (PEP)	>24	–	<–40
SSB, class-AB	28	28	–	30 (PEP)	typ. 20	typ. 40	typ. –35

Note

1. 2-tone efficiency.

HF power MOS transistor

BLF145

LIMITING VALUES

In accordance with the Absolute Maximum Rating System (IEC 60134).

SYMBOL	PARAMETER	CONDITIONS	MIN.	MAX.	UNIT
V_{DSS}	drain-source voltage		–	65	V
V_{GSS}	gate-source voltage		–	± 20	V
I_D	drain current (DC)		–	6	A
P_{tot}	total power dissipation	$T_{mb} \leq 25\text{ }^\circ\text{C}$	–	68	W
T_{stg}	storage temperature		–65	150	$^\circ\text{C}$
T_j	junction temperature		–	200	$^\circ\text{C}$

THERMAL CHARACTERISTICS

SYMBOL	PARAMETER	VALUE	UNIT
$R_{th\ j-mb}$	thermal resistance from junction to mounting base	2.6	K/W
$R_{th\ mb-h}$	thermal resistance from mounting base to heatsink	0.3	K/W

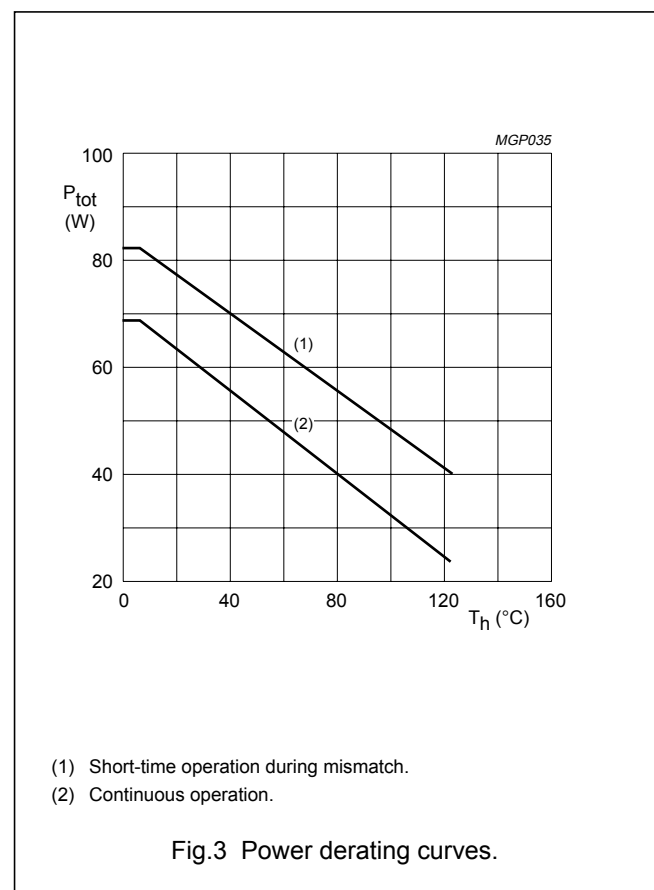
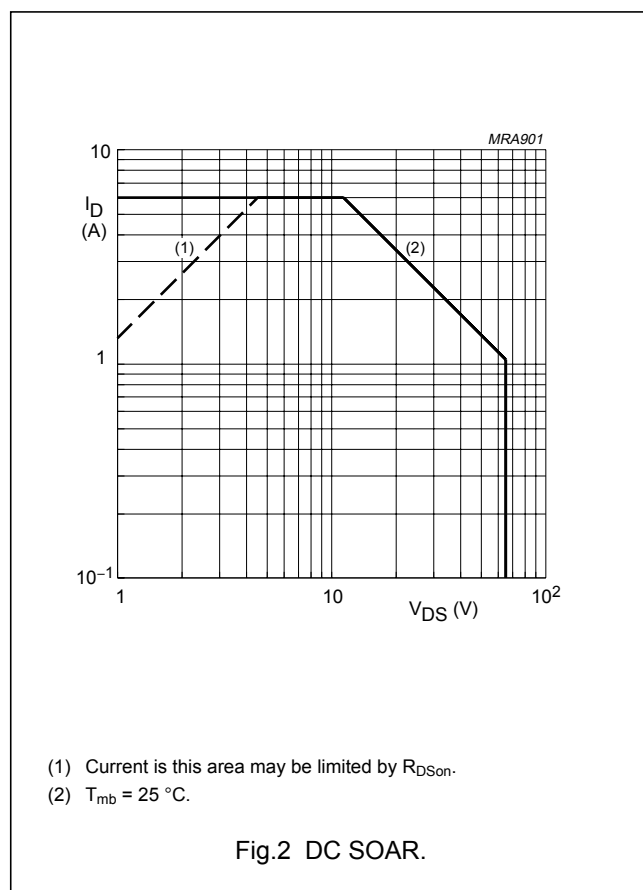

HF power MOS transistor

BLF145

CHARACTERISTICS $T_j = 25\text{ }^\circ\text{C}$ unless otherwise specified.

SYMBOL	PARAMETER	CONDITIONS	MIN.	TYP.	MAX.	UNIT
$V_{(BR)DSS}$	drain-source breakdown voltage	$I_D = 10\text{ mA}; V_{GS} = 0$	65	–	–	V
I_{DSS}	drain-source leakage current	$V_{GS} = 0; V_{DS} = 28\text{ V}$	–	–	2	mA
I_{GSS}	gate-source leakage current	$V_{GS} = \pm 20\text{ V}; V_{DS} = 0$	–	–	1	μA
V_{GSth}	gate-source threshold voltage	$I_D = 10\text{ mA}; V_{DS} = 10\text{ V}$	2	–	4.5	V
ΔV_{GS}	gate-source voltage difference of matched devices	$I_D = 10\text{ mA}; V_{DS} = 10\text{ V}$	–	–	100	mV
g_{fs}	forward transconductance	$I_D = 1.5\text{ A}; V_{DS} = 10\text{ V}$	1.2	–	–	S
R_{DSon}	drain-source on-state resistance	$I_D = 1.5\text{ A}; V_{GS} = 10\text{ V}$	–	0.4	0.75	Ω
I_{DSX}	on-state drain current	$V_{GS} = 10\text{ V}; V_{DS} = 10\text{ V}$	–	10	–	A
C_{is}	input capacitance	$V_{GS} = 0; V_{DS} = 28\text{ V}; f = 1\text{ MHz}$	–	125	–	pF
C_{os}	output capacitance	$V_{GS} = 0; V_{DS} = 28\text{ V}; f = 1\text{ MHz}$	–	75	–	pF
C_{rs}	feedback capacitance	$V_{GS} = 0; V_{DS} = 28\text{ V}; f = 1\text{ MHz}$	–	7	–	pF

 V_{GS} group indicator

GROUP	LIMITS (V)		GROUP	LIMITS (V)	
	MIN.	MAX.		MIN.	MAX.
A	2.0	2.1	O	3.3	3.4
B	2.1	2.2	P	3.4	3.5
C	2.2	2.3	Q	3.5	3.6
D	2.3	2.4	R	3.6	3.7
E	2.4	2.5	S	3.7	3.8
F	2.5	2.6	T	3.8	3.9
G	2.6	2.7	U	3.9	4.0
H	2.7	2.8	V	4.0	4.1
J	2.8	2.9	W	4.1	4.2
K	2.9	3.0	X	4.2	4.3
L	3.0	3.1	Y	4.3	4.4
M	3.1	3.2	Z	4.4	4.5
N	3.2	3.3			

HF power MOS transistor

BLF145

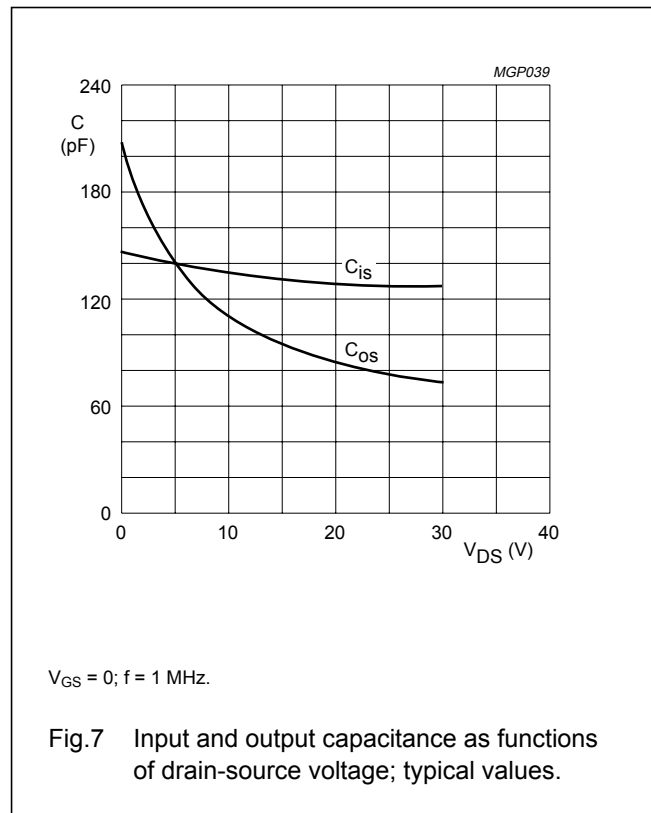
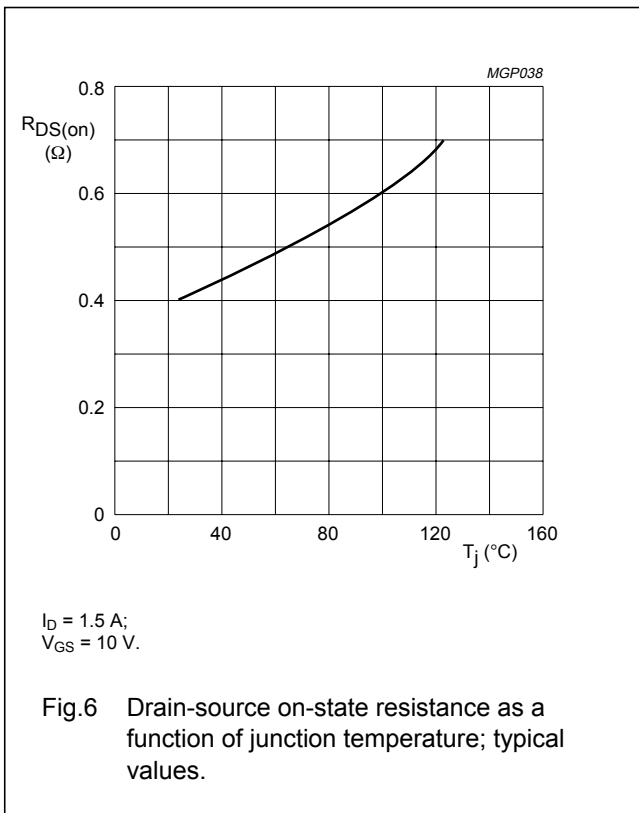
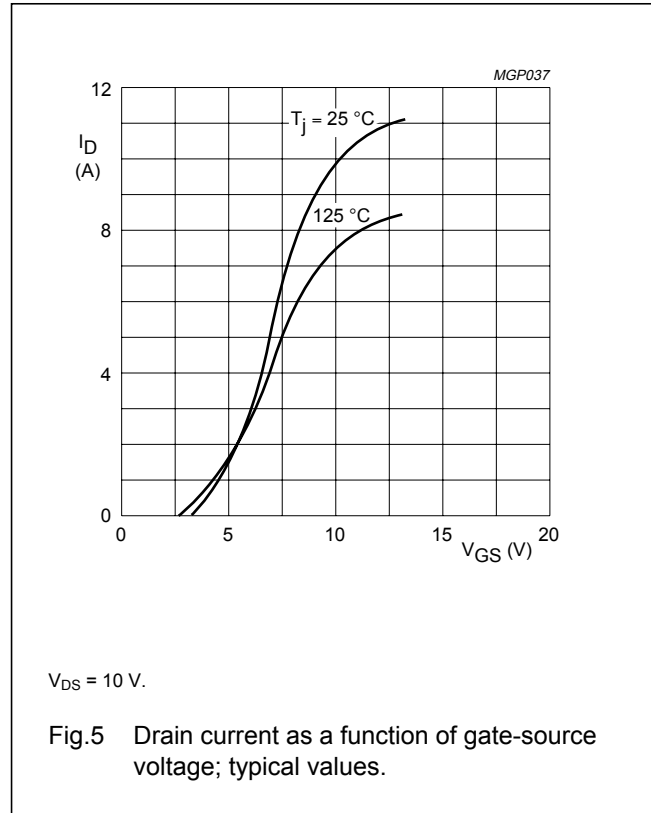
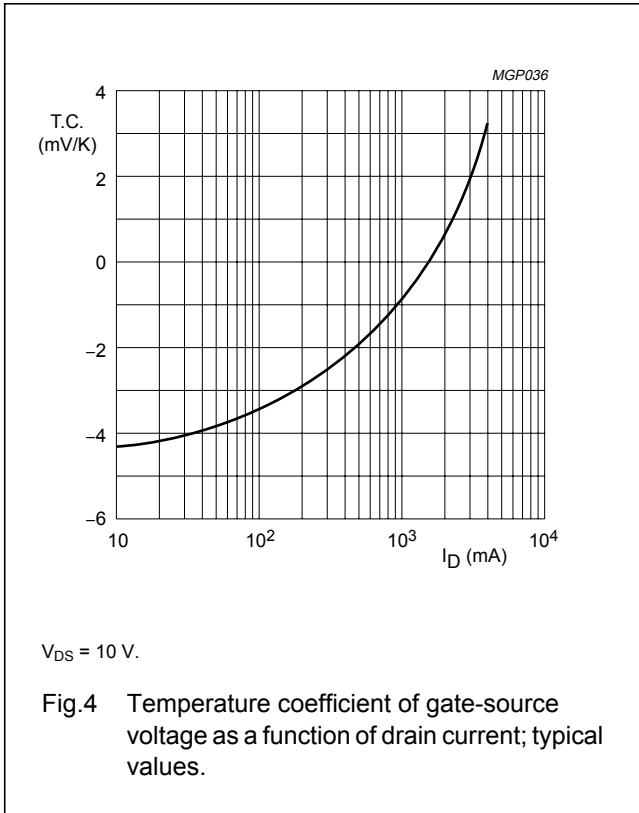

HF power MOS transistor

BLF145

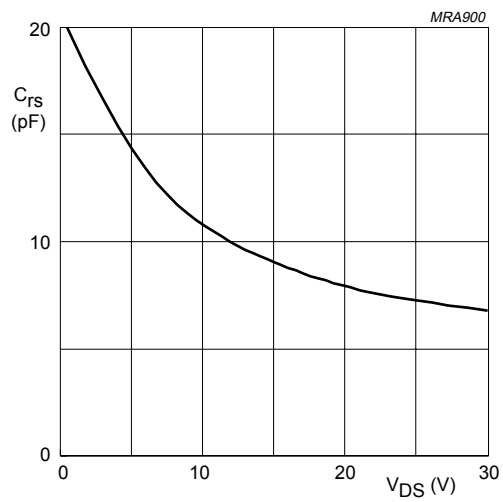

$V_{GS} = 0$; $f = 1$ MHz.

Fig.8 Feedback capacitance as a function of drain-source voltage, typical values.

HF power MOS transistor

BLF145

APPLICATION INFORMATION FOR CLASS-A OPERATION

$T_h = 25\text{ °C}$; $R_{th\text{ mb-h}} = 0.3\text{ K/W}$; $R_1 = 26\ \Omega$; unless otherwise specified.

RF performance in SSB operation in a common source class-A circuit.

MODE OF OPERATION	f (MHz)	V_{DS} (V)	I_D (A)	P_L (W)	G_p (dB)	d_3 (dB) ⁽¹⁾	d_5 (dB) ⁽¹⁾	Z_L (Ω)
SSB, class-A	28	28	1.3	8 (PEP)	>24 typ. 27	>-40 typ. -43	<-40 typ. -70	18.4 + j5.2

Note

1. Maximum values at drive levels within the specified PEP values for either amplified tone. For the peak envelope power the values should be decreased by 6 dB.

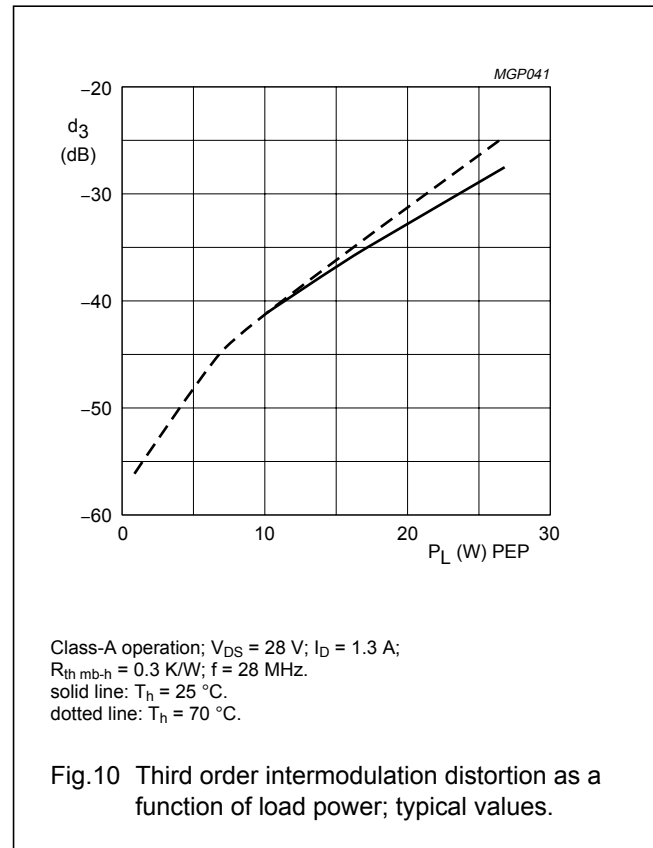
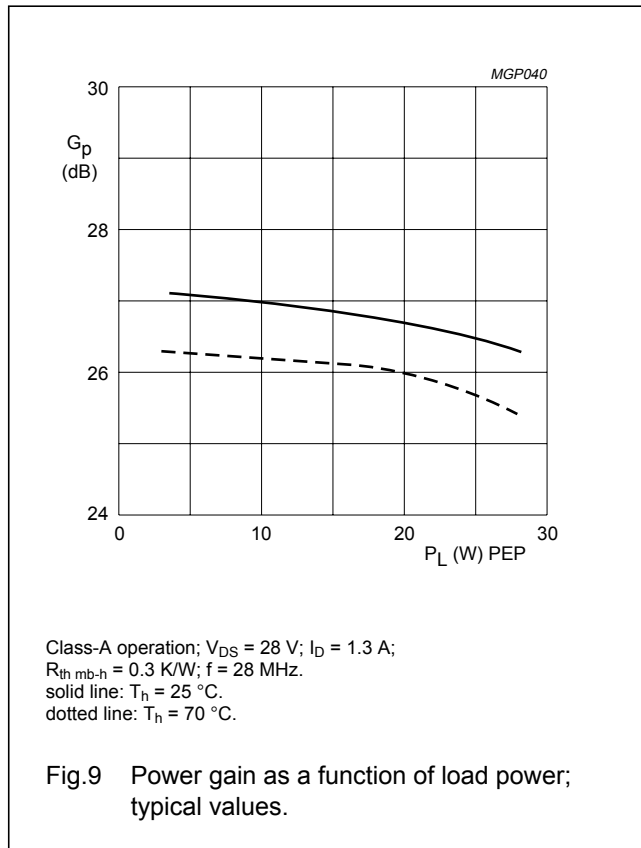

HF power MOS transistor

BLF145

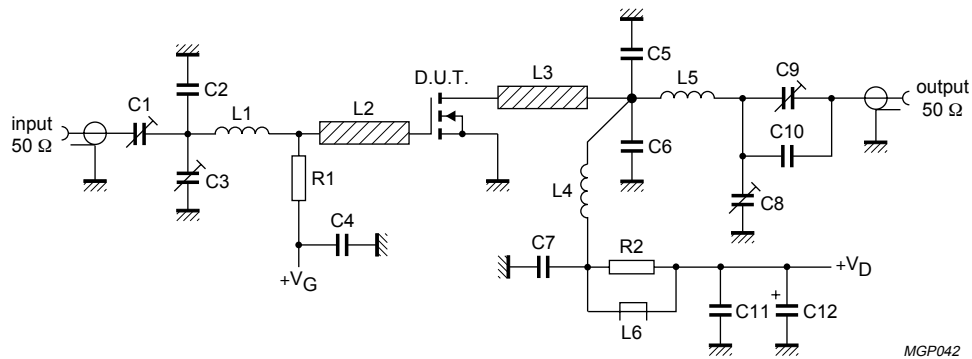

f = 28 MHz.

Fig.11 Test circuit for class-A operation.

List of components (see Fig.11)

COMPONENT	DESCRIPTION	VALUE	DIMENSIONS	CATALOGUE NO.
C1, C3, C8, C9	film dielectric trimmer	7 to 100 pF		2222 809 07015
C2, C10	multilayer ceramic chip capacitor; note 1	39 pF		
C4, C7	multilayer ceramic chip capacitor	100 nF		2222 852 47104
C5, C6	multilayer ceramic chip capacitor; note 1	27 pF		
C11	multilayer ceramic chip capacitor	3 × 100 nF		2222 852 47104
C12	electrolytic capacitor	2.2 μF, 63 V		2222 030 38228
L1	12 turns enamelled 0.5 mm copper wire	307 nH	length 8 mm; int. dia. 4 mm	
L2, L3	stripline; note 2	30 Ω	length 15 × 6 mm	
L4	14 turns enamelled 1 mm copper wire	1039 nH	length 14 mm; int. dia. 9 mm	
L5	9 turns enamelled 1 mm copper wire	305 nH	length 10 mm; int. dia. 6 mm	
L6	grade 3B Ferroxcube wideband HF choke			4312 020 36640
R1	0.25 W metal film resistor	26 Ω		
R2	0.25 W metal film resistor	10 Ω		

Notes

- American Technical Ceramics (ATC) capacitor, type 100B or other capacitor of the same quality.
- The striplines are on a double copper-clad printed circuit board, with epoxy dielectric ($\epsilon_r = 4.5$), thickness 1.6 mm.

HF power MOS transistor

BLF145

APPLICATION INFORMATION FOR CLASS-B OPERATION

$T_h = 25\text{ °C}$; $R_{th\ mb-h} = 0.3\text{ K/W}$; $R1 = 34\ \Omega$; unless otherwise specified.

RF performance in SSB operation in a common source class-AB circuit.

MODE OF OPERATION	f (MHz)	V_{DS} (V)	I_{DQ} (A)	P_L (W)	G_p (dB)	η_D (%)	d_3 (dB) ⁽¹⁾	d_5 (dB) ⁽¹⁾	Z_L (Ω)
SSB, class-AB	28	28	0.25	30 (PEP)	typ. 20	typ. 40	typ. -35	typ. -40	$8.9 + j1.0$

Note

- Maximum values at drive levels within the specified PEP values for either amplified tone. For the peak envelope power the values should be decreased by 6 dB.

Ruggedness in class-AB operation

The BLF145 is capable of withstanding a load mismatch corresponding to VSWR = 50 through all phases at $P_L = 30\text{ W}$ single tone under the following conditions:

$V_{DS} = 28\text{ V}$; $f = 28\text{ MHz}$; $T_h = 25\text{ °C}$; $R_{th\ mb-h} = 0.3\text{ K/W}$ at rated load power.

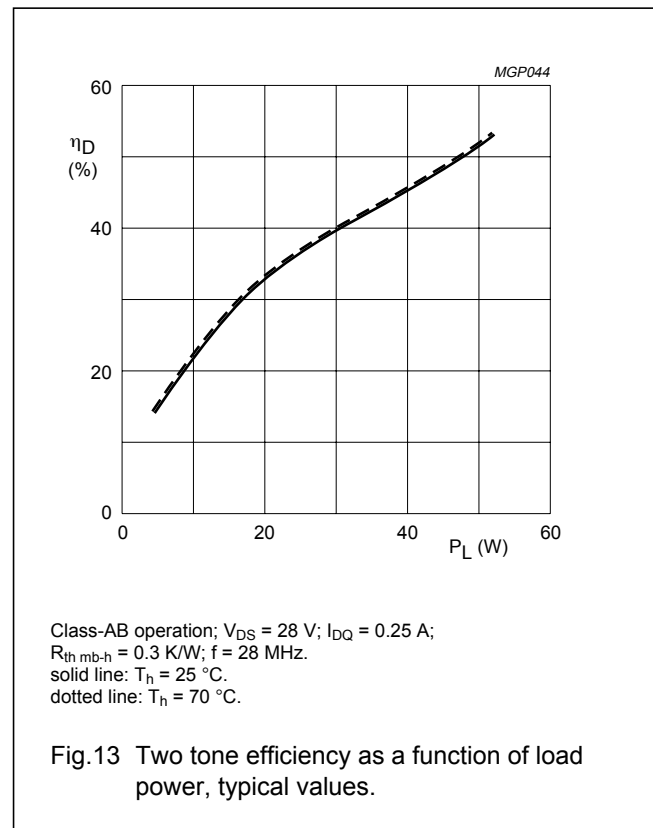
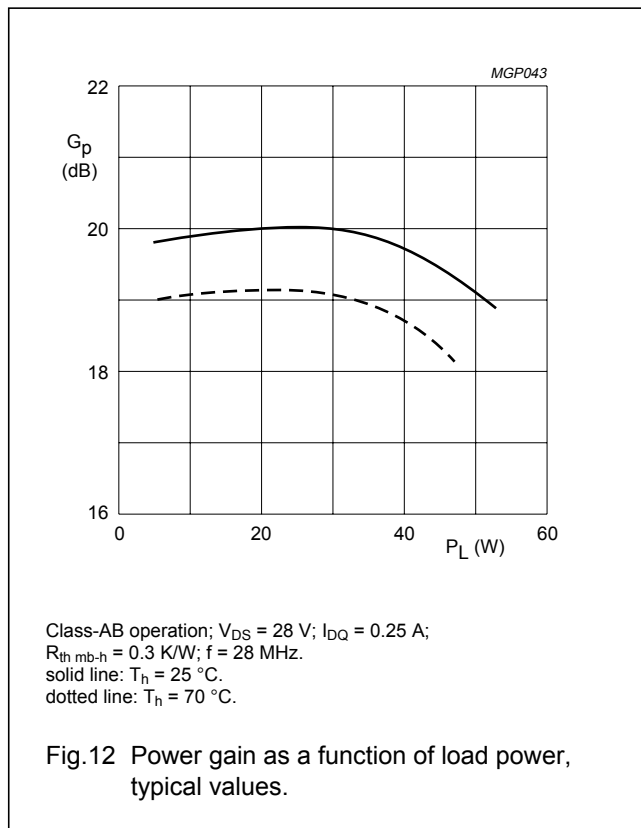

HF power MOS transistor

BLF145

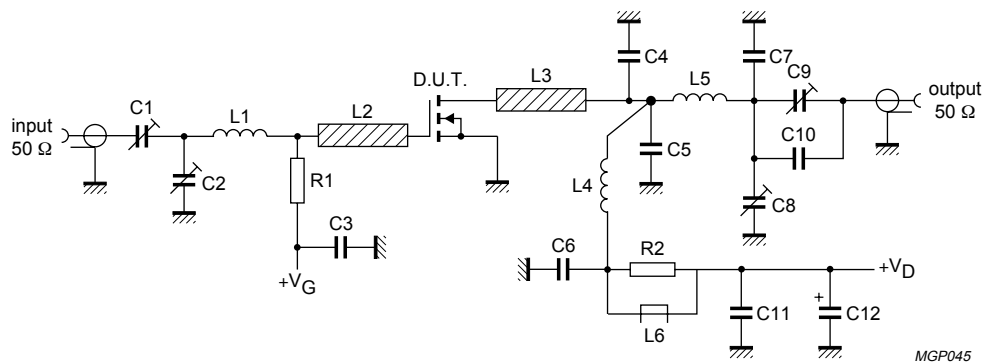

f = 28 MHz.

Fig.14 Test circuit for class-AB operation.

List of components (see Fig.14)

COMPONENT	DESCRIPTION	VALUE	DIMENSIONS	CATALOGUE NO.
C1, C2	film dielectric trimmer	5 to 60 pF		2222 809 07011
C3, C6	multilayer ceramic chip capacitor	100 nF		2222 852 47104
C4, C5	multilayer ceramic chip capacitor; note 1	27 pF		
C7, C10	multilayer ceramic chip capacitor; note 1	39 pF		
C8, C9	film dielectric trimmer	7 to 100 pF		2222 809 07015
C11	multilayer ceramic chip capacitor	3 × 100 nF		2222 852 47104
C12	electrolytic capacitor	2.2 μF, 63 V		2222 030 38228
L1	13 turns enamelled 0.5 mm copper wire	415 nH	length 10 mm; int. dia. 5 mm	
L2, L3	stripline; note 2	30 Ω	length 15 × 6 mm	
L4	10 turns enamelled 1 mm copper wire	390 nH	length 13 mm; int. dia. 7 mm	
L5	9 turns enamelled 1 mm copper wire	245 nH	length 10 mm; int. dia. 5 mm	
L6	grade 3B Ferroxcube wideband HF choke			4312 020 36640
R1	0.5 W metal film resistor	34 Ω		
R2	0.25 W metal film resistor	10 Ω		

Notes

- American Technical Ceramics (ATC) capacitor, type 100B or other capacitor of the same quality.
- The striplines are on a double copper-clad printed circuit board, with epoxy dielectric ($\epsilon_r = 4.5$), thickness 1.6 mm.

HF power MOS transistor

BLF145

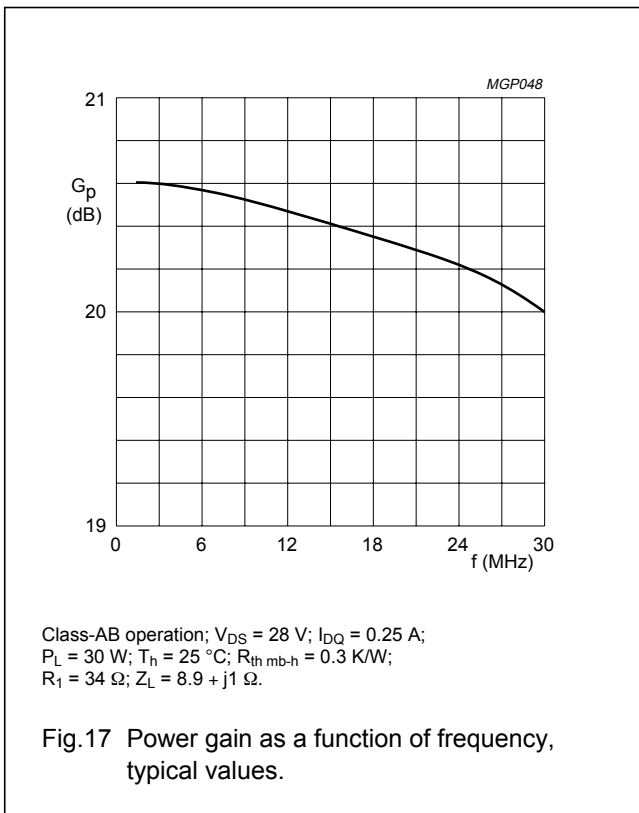
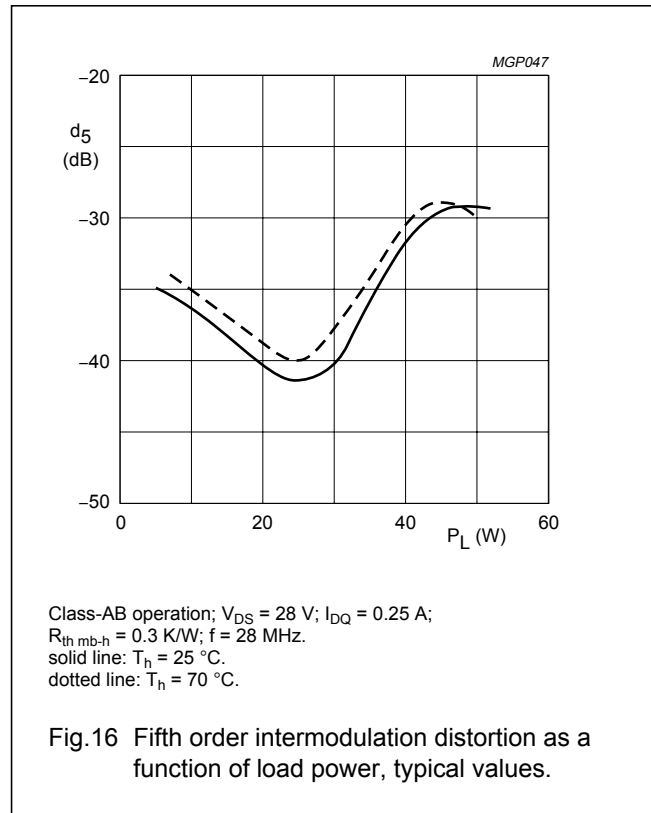
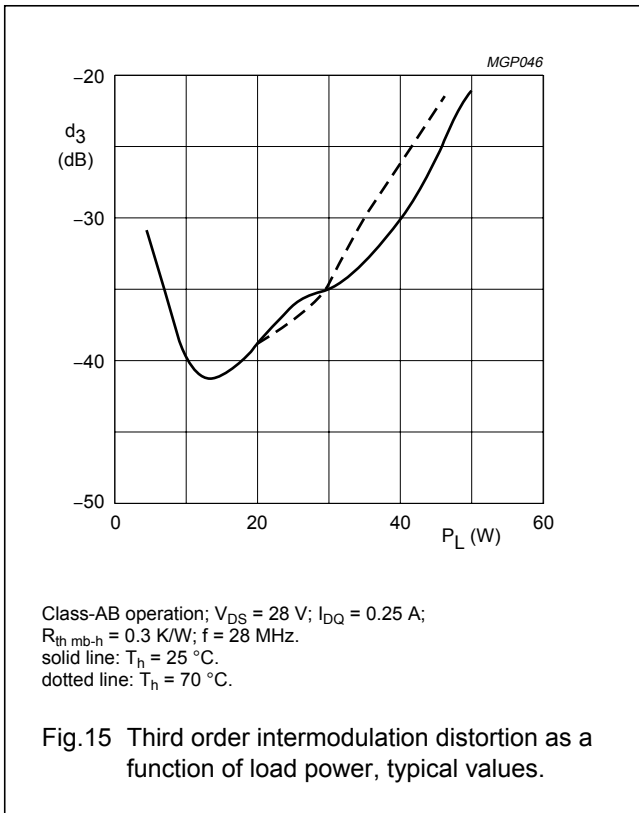

Table 1

Input impedance as a function of frequency
 Class-AB operation; $V_{DS} = 28\text{ V}$; $I_{DQ} = 0.25\text{ A}$; $P_L = 30\text{ W}$;
 $T_h = 25\text{ °C}$; $R_{th\text{ mb-h}} = 0.3\text{ K/W}$; $R_1 = 34\text{ }\Omega$;
 $Z_L = 8.9 + j1\text{ }\Omega$.

f (MHz)	Z _i (Ω)
1.5	32.9 – j2.2
3.0	32.4 – j4.3
6.0	30.7 – j8.1
10	27.4 – j11.9
15	32.9 – j14.6
20	18.5 – j15.4
25	15.1 – j15.3
30	12.5 – j14.6

HF power MOS transistor

BLF145

BLF145 scattering parameters

 $V_{DS} = 28\text{ V}$; $I_D = 250\text{ mA}$; note 1

f (MHz)	S ₁₁		S ₂₁		S ₁₂		S ₂₂	
	S ₁₁	∠ Φ	S ₂₁	∠ Φ	S ₁₂	∠ Φ	S ₂₂	∠ Φ
5	0.90	-70.90	62.40	138.40	0.02	49.80	0.83	-67.60
10	0.81	-108.90	42.47	117.90	0.03	30.70	0.72	-105.00
20	0.76	-140.20	23.90	100.40	0.03	16.40	0.66	-135.80
30	0.75	-151.90	16.27	92.20	0.03	10.50	0.65	-147.90
40	0.75	-157.90	12.18	86.50	0.03	8.00	0.64	-153.40
50	0.75	-161.40	9.70	82.00	0.03	6.60	0.65	-156.40
60	0.76	-163.70	8.01	78.10	0.03	5.80	0.66	-158.30
70	0.77	-165.30	6.78	74.50	0.03	5.60	0.67	-159.70
80	0.77	-166.60	5.85	71.30	0.03	6.20	0.68	-160.50
90	0.78	-167.50	5.14	68.30	0.02	7.30	0.69	-161.20
100	0.79	-168.40	4.56	65.30	0.02	8.80	0.71	-162.00
125	0.81	-170.40	3.48	58.20	0.02	15.50	0.74	-163.70
150	0.83	-172.00	2.74	52.50	0.02	27.00	0.77	-164.90
175	0.85	-173.60	2.23	47.70	0.02	41.30	0.80	-166.20
200	0.87	-175.20	1.86	43.00	0.02	54.50	0.82	-168.00
250	0.89	-178.40	1.32	35.30	0.03	72.80	0.86	-171.20
300	0.91	178.50	1.00	29.70	0.04	80.50	0.89	-174.20
350	0.93	175.50	0.77	25.50	0.05	83.90	0.91	-177.10
400	0.94	172.60	0.62	22.90	0.06	84.80	0.93	-179.90
450	0.94	169.90	0.50	20.90	0.07	85.30	0.94	177.60
500	0.95	167.20	0.43	20.30	0.08	84.20	0.94	175.10
600	0.95	161.90	0.32	21.60	0.10	82.40	0.95	170.60
700	0.95	156.80	0.26	25.40	0.12	79.90	0.96	166.40
800	0.94	151.90	0.23	31.50	0.14	78.20	0.96	162.30
900	0.94	147.20	0.22	38.60	0.16	74.10	0.94	158.60
1000	0.94	142.10	0.23	48.40	0.15	75.40	0.94	162.10

Note

- For more extensive s-parameters see internet:
<http://www.semiconductors.philips.com/markets/communications/wirelesscommunication/broadcast>.

HF power MOS transistor

BLF145

PACKAGE OUTLINE

Flanged ceramic package; 2 mounting holes; 4 leads

SOT123A

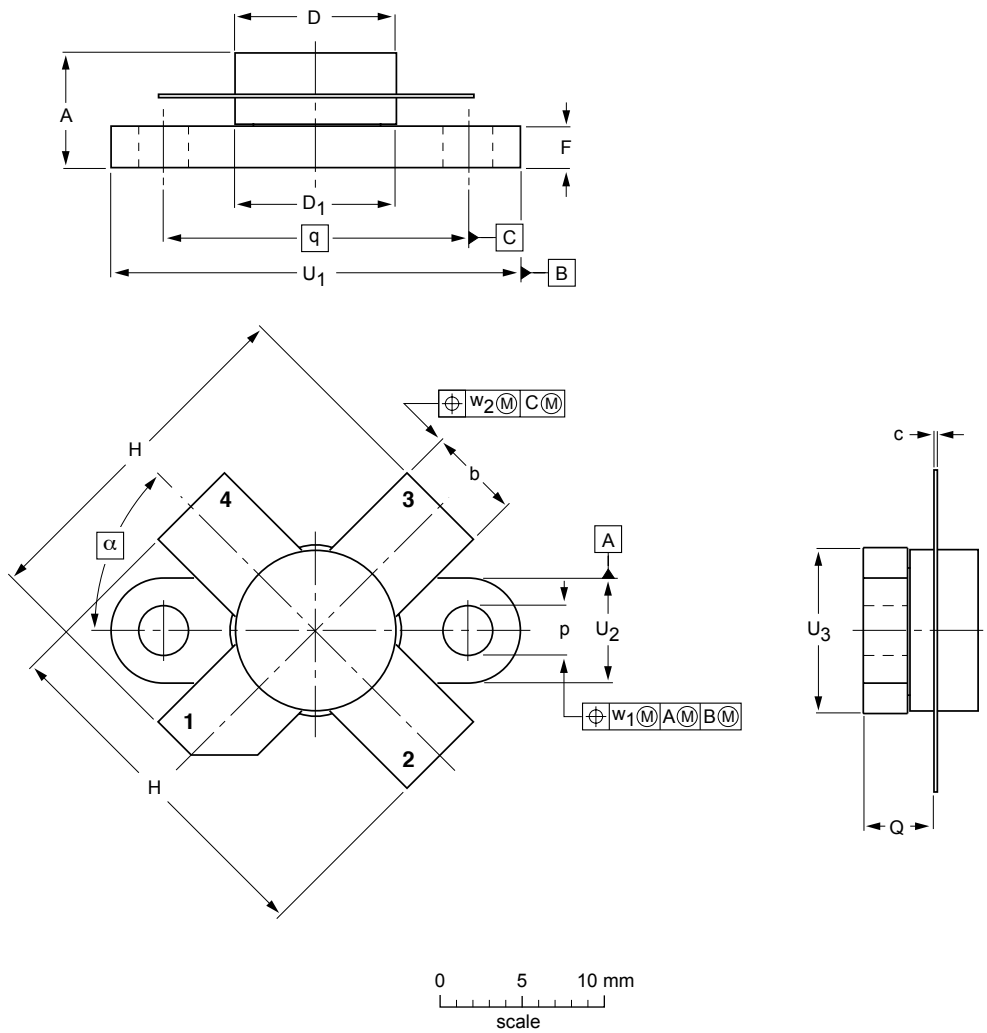

DIMENSIONS (millimetre dimensions are derived from the original inch dimensions)

UNIT	A	b	c	D	D ₁	F	H	p	Q	q	U ₁	U ₂	U ₃	w ₁	w ₂	α
mm	7.47 6.37	5.82 5.56	0.18 0.10	9.73 9.47	9.78 9.42	2.72 2.31	20.71 19.93	3.33 3.04	4.63 4.11	18.42	24.87 24.64	6.48 6.22	9.78 9.39	0.25	0.51	45°
inches	0.294 0.251	0.229 0.219	0.007 0.004	0.383 0.373	0.385 0.371	0.107 0.091	0.815 0.785	0.131 0.120	0.182 0.162	0.725	0.980 0.970	0.255 0.245	0.385 0.370	0.010	0.020	

OUTLINE VERSION	REFERENCES				EUROPEAN PROJECTION	ISSUE DATE
	IEC	JEDEC	EIAJ			
SOT123A						99-03-29

Legal information

Data sheet status

Document status ^{[1][2]}	Product status ^[3]	Definition
Objective [short] data sheet	Development	This document contains data from the objective specification for product development.
Preliminary [short] data sheet	Qualification	This document contains data from the preliminary specification.
Product [short] data sheet	Production	This document contains the product specification.

[1] Please consult the most recently issued document before initiating or completing a design.

[2] The term 'short data sheet' is explained in section "Definitions".

[3] The product status of device(s) described in this document may have changed since this document was published and may differ in case of multiple devices. The latest product status information is available on the Internet at URL <http://www.ampleon.com>.

Definitions

Draft — The document is a draft version only. The content is still under internal review and subject to formal approval, which may result in modifications or additions. Ampleon does not give any representations or warranties as to the accuracy or completeness of information included herein and shall have no liability for the consequences of use of such information.

Short data sheet — A short data sheet is an extract from a full data sheet with the same product type number(s) and title. A short data sheet is intended for quick reference only and should not be relied upon to contain detailed and full information. For detailed and full information see the relevant full data sheet, which is available on request via the local Ampleon sales office. In case of any inconsistency or conflict with the short data sheet, the full data sheet shall prevail.

Product specification — The information and data provided in a Product data sheet shall define the specification of the product as agreed between Ampleon and its customer, unless Ampleon and customer have explicitly agreed otherwise in writing. In no event however, shall an agreement be valid in which the Ampleon product is deemed to offer functions and qualities beyond those described in the Product data sheet.

Disclaimers

Limited warranty and liability — Information in this document is believed to be accurate and reliable. However, Ampleon does not give any representations or warranties, expressed or implied, as to the accuracy or completeness of such information and shall have no liability for the consequences of use of such information. Ampleon takes no responsibility for the content in this document if provided by an information source outside of Ampleon.

In no event shall Ampleon be liable for any indirect, incidental, punitive, special or consequential damages (including - without limitation - lost profits, lost savings, business interruption, costs related to the removal or replacement of any products or rework charges) whether or not such damages are based on tort (including negligence), warranty, breach of contract or any other legal theory.

Notwithstanding any damages that customer might incur for any reason whatsoever, Ampleon' aggregate and cumulative liability towards customer for the products described herein shall be limited in accordance with the *Terms and conditions of commercial sale* of Ampleon.

Right to make changes — Ampleon reserves the right to make changes to information published in this document, including without limitation specifications and product descriptions, at any time and without notice. This document supersedes and replaces all information supplied prior to the publication hereof.

Suitability for use — Ampleon products are not designed, authorized or warranted to be suitable for use in life support, life-critical or safety-critical systems or equipment, nor in applications where failure or malfunction of an

Ampleon product can reasonably be expected to result in personal injury, death or severe property or environmental damage. Ampleon and its suppliers accept no liability for inclusion and/or use of Ampleon products in such equipment or applications and therefore such inclusion and/or use is at the customer's own risk.

Applications — Applications that are described herein for any of these products are for illustrative purposes only. Ampleon makes no representation or warranty that such applications will be suitable for the specified use without further testing or modification.

Customers are responsible for the design and operation of their applications and products using Ampleon products, and Ampleon accepts no liability for any assistance with applications or customer product design. It is customer's sole responsibility to determine whether the Ampleon product is suitable and fit for the customer's applications and products planned, as well as for the planned application and use of customer's third party customer(s). Customers should provide appropriate design and operating safeguards to minimize the risks associated with their applications and products.

Ampleon does not accept any liability related to any default, damage, costs or problem which is based on any weakness or default in the customer's applications or products, or the application or use by customer's third party customer(s). Customer is responsible for doing all necessary testing for the customer's applications and products using Ampleon products in order to avoid a default of the applications and the products or of the application or use by customer's third party customer(s). Ampleon does not accept any liability in this respect.

Limiting values — Stress above one or more limiting values (as defined in the Absolute Maximum Ratings System of IEC 60134) will cause permanent damage to the device. Limiting values are stress ratings only and (proper) operation of the device at these or any other conditions above those given in the Recommended operating conditions section (if present) or the Characteristics sections of this document is not warranted. Constant or repeated exposure to limiting values will permanently and irreversibly affect the quality and reliability of the device.

Terms and conditions of commercial sale — Ampleon products are sold subject to the general terms and conditions of commercial sale, as published at <http://www.ampleon.com/terms>, unless otherwise agreed in a valid written individual agreement. In case an individual agreement is concluded only the terms and conditions of the respective agreement shall apply. Ampleon hereby expressly objects to applying the customer's general terms and conditions with regard to the purchase of Ampleon products by customer.

No offer to sell or license — Nothing in this document may be interpreted or construed as an offer to sell products that is open for acceptance or the grant, conveyance or implication of any license under any copyrights, patents or other industrial or intellectual property rights.

Export control — This document as well as the item(s) described herein may be subject to export control regulations. Export might require a prior authorization from competent authorities.

Non-automotive qualified products — Unless this data sheet expressly states that this specific Ampleon product is automotive qualified, the product is not suitable for automotive use. It is neither qualified nor tested in accordance with automotive testing or application requirements. Ampleon accepts no liability for inclusion and/or use of non-automotive qualified products in automotive equipment or applications.

In the event that customer uses the product for design-in and use in automotive applications to automotive specifications and standards, customer (a) shall use the product without Ampleon' warranty of the product for such automotive applications, use and specifications, and (b) whenever customer uses the product for automotive applications beyond Ampleon' specifications such use shall be solely at customer's own risk, and (c) customer fully indemnifies Ampleon for any liability, damages or failed product claims resulting from customer design and use of the product for automotive applications beyond Ampleon' standard warranty and Ampleon' product specifications.

Translations — A non-English (translated) version of a document is for reference only. The English version shall prevail in case of any discrepancy between the translated and English versions.

Contact information

For more information, please visit:
<http://www.ampleon.com>

Trademarks

Notice: All referenced brands, product names, service names and trademarks are the property of their respective owners.

Any reference or use of any 'NXP' trademark in this document or in or on the surface of Ampleon products does not result in any claim, liability or entitlement vis-à-vis the owner of this trademark. Ampleon is no longer part of the NXP group of companies and any reference to or use of the 'NXP' trademarks will be replaced by reference to or use of Ampleon's own Any reference or use of any 'NXP' trademark in this document or in or on the surface of Ampleon products does not result in any claim, liability or entitlement vis-à-vis the owner of this trademark. Ampleon is no longer part of the NXP group of companies and any reference to or use of the 'NXP' trademarks will be replaced by reference to or use of Ampleon's own trademarks.

For sales office addresses, please visit:
<http://www.ampleon.com/sales>

Revision history

Document ID	Release date	Data sheet status	Change notice	Supersedes
BLF145#5	20150901	Product data sheet	-	BLF145_N_4
Modifications:	<ul style="list-style-type: none"> The format of this document has been redesigned to comply with the new identity guidelines of Ampleon. Legal texts have been adapted to the new company name where appropriate. 			
BLF145_N4	20070105	Product data sheet	-	BLF145_3
BLF145_3 (9397 750 11581)	20031013	Product specification	-	BLF145_CNV_2
BLF145_CNV_2 (9397 750 xxxxx)	19971212	Product specification	-	-

Please be aware that important notices concerning this document and the product(s) described herein, have been included in section 'Legal information'.

© Ampleon B.V. 2015.

All rights reserved.

For more information, please visit: <http://www.ampleon.com>

For sales office addresses, please visit: <http://www.ampleon.com/sales>

Date of release: 1 September 2015

Document identifier: BLF145#5