

BGU7062N2

Analog high linearity low noise variable gain amplifier

Rev. 1 — 8 July 2013

Product data sheet

1. Product profile

1.1 General description

The BGU7062N2 is a fully integrated analog-controlled variable gain amplifier module. Its low noise and high linearity performance makes it ideal for sensitive receivers in cellular base station applications. The BGU7062N2 is designed for the 1710 MHz to 1785 MHz frequency range. It has a gain control range of more than 35 dB. At maximum gain the noise figure is 0.77 dB. The gain is analog-controlled having maximum gain at 0 V and minimum gain at 3.3 V. The LNA can be bypassed extending the dynamic range. The BGU7062N2 is internally matched to 50 ohm, meaning no external matching is required, enabling ease of use. It is housed in a 16 pins 8 mm × 8 mm × 1.3 mm leadless HLQFN16R package SOT1301.

1.2 Features and benefits

- Input and output internally matched to 50 Ω
- Low noise figure of 0.77 dB
- High IP_{3i} of 1 dBm
- High P_{i(1dB)} of -12.3 dBm
- Bypass mode of LNA giving high dynamic gain range
- Gain control range of 0 dB to 35 dB
- Single 5 V supply
- Single analog gain control of 0 V to 3.3 V
- Unconditionally stable up to 12.75 GHz
- Moisture sensitivity level 3
- ESD protection at all pins

1.3 Applications

- Cellular base stations, remote radio heads
- 3G, LTE infrastructure
- Low noise applications with variable gain and high linearity requirements
- Active antenna



1.4 Quick reference data

Table 1. Quick reference data

$V_{CC1} = 5\text{ V}$; $V_{CC2} = 5\text{ V}$; $f = 1750\text{ MHz}$; $T_{amb} = 25\text{ }^\circ\text{C}$; input and output $50\text{ }\Omega$; unless otherwise specified.

Symbol	Parameter	Conditions	Min	Typ	Max	Unit
$I_{CC(tot)}$	total supply current	high gain mode	[1] 190	215	250	mA
		low gain mode	[2] 165	185	215	mA
NF	noise figure	$V_{ctrl(Gp)} = 0\text{ V}$ (maximum power gain)	[1] -	0.77	-	dB
		$G_p = 35\text{ dB}$	[1] -	0.94	1.1	dB
$IP3_i$	input third-order intercept point	$G_p = 35\text{ dB}$; 2-tone; tone-spacing = 1.0 MHz	[1] 0	1.0	-	dBm
$P_{i(1dB)}$	input power at 1 dB gain compression	$G_p = 35\text{ dB}$	[1] -14	-12.3	-	dBm

[1] high gain mode: GS1 = LOW; GS2 = HIGH (see Table 9)

[2] low gain mode: GS1 = HIGH; GS2 = LOW (see Table 9)

2. Pinning information

2.1 Pinning

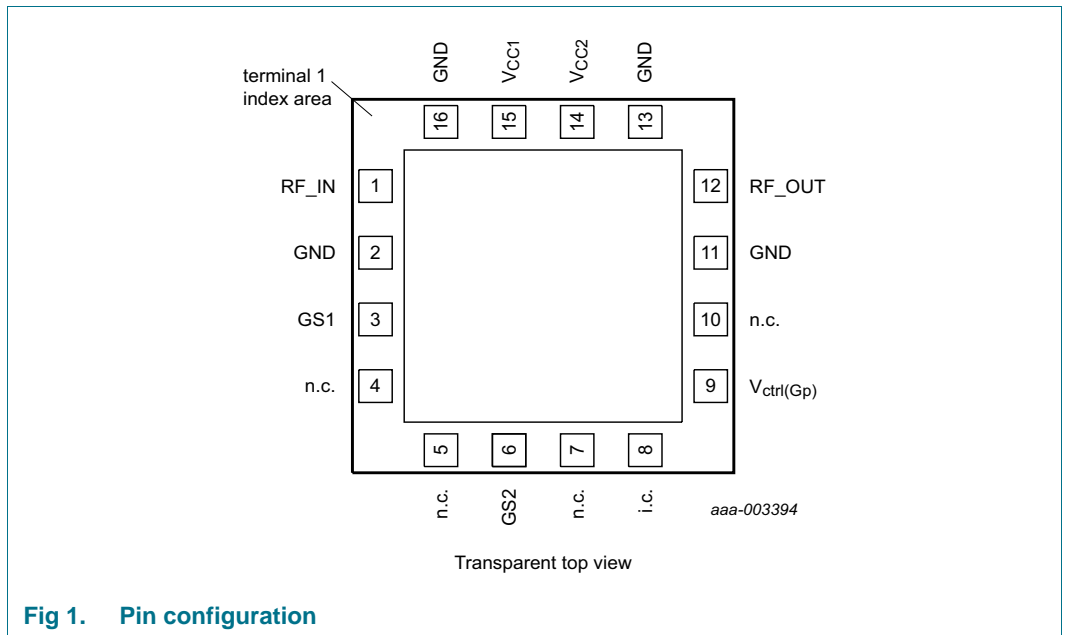

Fig 1. Pin configuration

2.2 Pin description

Table 2. Pin description

Symbol	Pin	Description
RF_IN	1	RF input
GND	2, 11, 13, 16	ground
GS1	3	gain switch control 1
n.c.	4, 5, 7, 10	not connected, internally open

Table 2. Pin description ...continued

Symbol	Pin	Description
GS2	6	gain switch control 2
i.c.	8	internally connected to ground
V _{ctrl(Gp)}	9	power gain control voltage
RF_OUT	12	RF output
V _{CC2}	14	supply voltage 2
V _{CC1}	15	supply voltage 1

3. Ordering information

Table 3. Ordering information

Type number	Package		
	Name	Description	Version
BGU7062N2	HLQFN16R	plastic thermal enhanced low profile quad flat package; no leads; 16 terminals; body 8 × 8 × 1.3 mm	SOT1301-1

4. Functional diagram

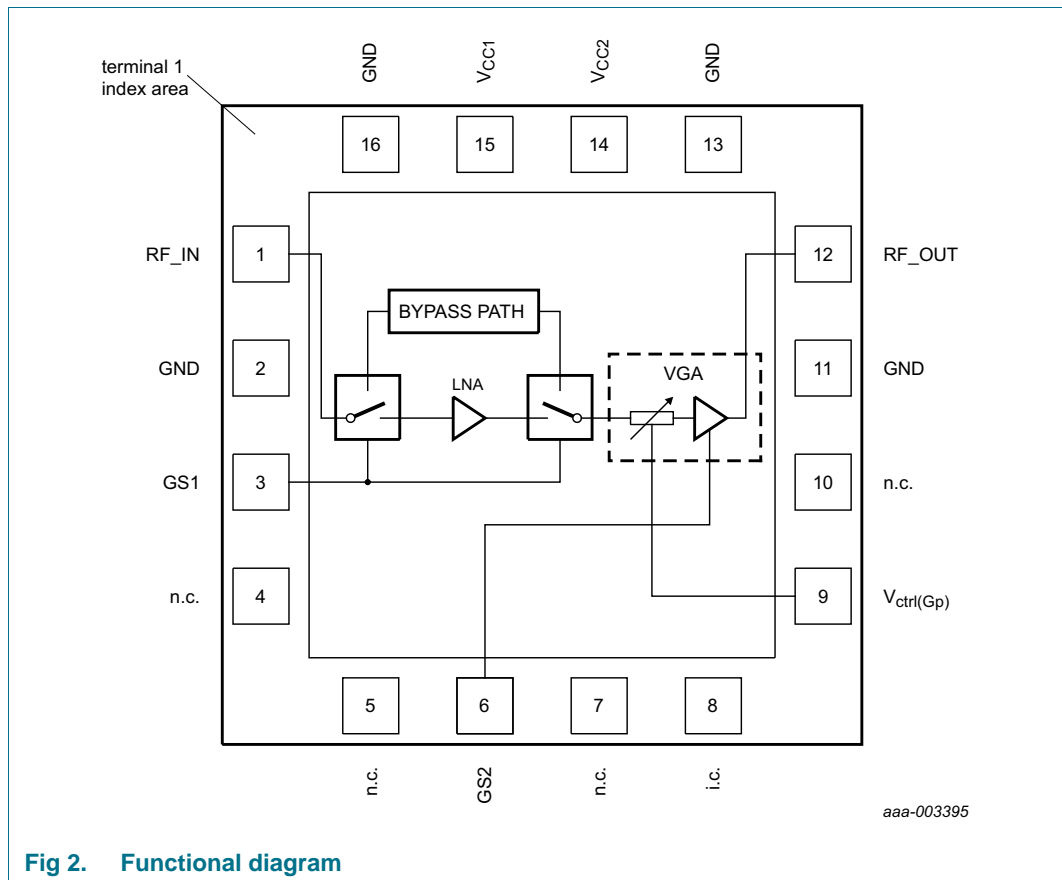

Fig 2. Functional diagram

5. Limiting values

Table 4. Limiting values

In accordance with the Absolute Maximum Rating System (IEC 60134).

Symbol	Parameter	Conditions	Min	Max	Unit
V_{CC}	supply voltage		0	6	V
$V_{ctrl(Gp)}$	power gain control voltage		-1	+3.6	V
$V_{I(GS1)}$	input voltage on pin GS1		-1	+3.6	V
$V_{I(GS2)}$	input voltage on pin GS2		-1	+3.6	V
$P_{i(RF)CW}$	continuous waveform RF input power	high gain mode; $V_{ctrl(Gp)} = 0$ V; $1710 \text{ MHz} \leq f \leq 1785 \text{ MHz}$ [1]	-	10	dBm
		low gain mode; $V_{ctrl(Gp)} = 0$ V; $1710 \text{ MHz} \leq f \leq 1785 \text{ MHz}$ [2]	-	15	dBm
T_j	junction temperature		-	150	°C
T_{stg}	storage temperature		-40	+150	°C
V_{ESD}	electrostatic discharge voltage	Human Body Model (HBM); according to ANSI/ESDA-JEDEC JS-001-2010-Device Testing, Human Body Model	-	±2	kV
		Charged Device Model (CDM); according to JEDEC standard 22-C101	-	±750	V

[1] high gain mode: GS1 = LOW; GS2 = HIGH (see [Table 9](#))

[2] low gain mode: GS1 = HIGH; GS2 = LOW (see [Table 9](#))

6. Recommended operating conditions

Table 5. Recommended operating conditions

Symbol	Parameter	Conditions	Min	Typ	Max	Unit
V_{CC1}	supply voltage 1		4.75	5	5.25	V
V_{CC2}	supply voltage 2		4.75	5	5.25	V
$V_{ctrl(Gp)}$	power gain control voltage		0	-	3.3	V
$V_{I(GS1)}$	input voltage on pin GS1		0	-	3.3	V
$V_{I(GS2)}$	input voltage on pin GS2		0	-	3.3	V
Z_0	characteristic impedance		-	50	-	Ω
T_{case}	case temperature		-40	-	+85	°C

7. Thermal characteristics

Table 6. Thermal characteristics

Symbol	Parameter	Conditions	Typ	Unit
$R_{th(j-case)}$	thermal resistance from junction to case		[1] 42	K/W

[1] The case temperature is measured at the ground solder pad.

8. Characteristics

Table 7. Characteristics high gain mode

GS1 = LOW; GS2 = HIGH (see [Table 9](#)); $V_{CC1} = 5\text{ V}$; $V_{CC2} = 5\text{ V}$; $f = 1750\text{ MHz}$; $T_{amb} = 25\text{ °C}$; input and output $50\ \Omega$; unless otherwise specified. All RF parameters have been characterized at the device RF input and RF output terminals.

Symbol	Parameter	Conditions	Min	Typ	Max	Unit
$I_{CC(tot)}$	total supply current		190	215	250	mA
$G_{p(min)}$	minimum power gain	$V_{ctrl(Gp)} = 3.3\text{ V}$	-	13.3	-	dB
$G_{p(max)}$	maximum power gain	$V_{ctrl(Gp)} = 0\text{ V}$	-	37.2	-	dB
$G_{p(Flat)}$	power gain flatness	$1710\text{ MHz} \leq f \leq 1785\text{ MHz}$; $18\text{ dB} \leq G_p \leq 35\text{ dB}$	-	0.3	-	dB
NF	noise figure	$V_{ctrl(Gp)} = 0\text{ V}$ (maximum power gain)	-	0.77	-	dB
		$G_p = 35\text{ dB}$	-	0.94	1.1	dB
		$G_p = 18\text{ dB}$	-	5.95	-	dB
IP _{3i}	input third-order intercept point	2-tone; tone-spacing = 1.0 MHz				
		$G_p = 35\text{ dB}$	0	1.0	-	dBm
		$G_p = 30\text{ dB}$	-	3.6	-	dBm
		$G_p = 29\text{ dB}$	-	4.0	-	dBm
P _{i(1dB)}	input power at 1 dB gain compression	$G_p = 35\text{ dB}$	-14	-12.3	-	dBm
		$G_p = 30\text{ dB}$	-	-7.2	-	dBm
		$G_p = 29\text{ dB}$	-	-6.8	-	dBm
		$G_p = 18\text{ dB}$	-	-6.1	-	dBm
RL _{in}	input return loss	$V_{ctrl(Gp)} = 0\text{ V}$ (maximum power gain)	-	24.9	-	dB
		$G_p = 35\text{ dB}$	-	23.5	-	dB
RL _{out}	output return loss	$V_{ctrl(Gp)} = 0\text{ V}$ (maximum power gain)	-	17.5	-	dB
K	Rollett stability factor	$0\text{ GHz} \leq f \leq 12.75\text{ GHz}$	1	-	-	

Table 8. Characteristics low gain mode

GS1 = HIGH; GS2 = LOW (see [Table 9](#)); $V_{CC1} = 5\text{ V}$; $V_{CC2} = 5\text{ V}$; $f = 1750\text{ MHz}$; $T_{amb} = 25\text{ °C}$; input and output $50\ \Omega$; unless otherwise specified. All RF parameters have been characterized at the device RF input and RF output terminals.

Symbol	Parameter	Conditions	Min	Typ	Max	Unit
$I_{CC(tot)}$	total supply current		165	185	215	mA
$G_{p(min)}$	minimum power gain	$V_{ctrl(Gp)} = 3.3\text{ V}$	-	-6.5	-	dB
$G_{p(max)}$	maximum power gain	$V_{ctrl(Gp)} = 0\text{ V}$	-	18.0	-	dB
$G_{p(Flat)}$	power gain flatness	$1710\text{ MHz} \leq f \leq 1785\text{ MHz}$; $3\text{ dB} \leq G_p \leq 17\text{ dB}$	-	0.2	-	dB
NF	noise figure	$G_p = 17\text{ dB}$	-	10.5	-	dB
		$G_p = 3\text{ dB}$	-	22.1	-	dB
IP _{3i}	input third-order intercept point	2-tone; tone-spacing = 1.0 MHz				
		$G_p = 17\text{ dB}$	-	20.9	-	dBm
		$G_p = 12\text{ dB}$	-	25.1	-	dBm
		$G_p = 11\text{ dB}$	-	25.9	-	dBm
		$G_p = 3\text{ dB}$	-	30.0	-	dBm

Table 8. Characteristics low gain mode ...continued

GS1 = HIGH; GS2 = LOW (see Table 9); $V_{CC1} = 5\text{ V}$; $V_{CC2} = 5\text{ V}$; $f = 1750\text{ MHz}$; $T_{amb} = 25\text{ }^\circ\text{C}$; input and output $50\text{ }\Omega$; unless otherwise specified. All RF parameters have been characterized at the device RF input and RF output terminals.

Symbol	Parameter	Conditions	Min	Typ	Max	Unit
$P_{i(1dB)}$	input power at 1 dB gain compression	$G_p = 17\text{ dB}$	-	5.8	-	dBm
		$G_p = 12\text{ dB}$	-	9.9	-	dBm
		$G_p = 11\text{ dB}$	-	10.3	-	dBm
		$G_p = 3\text{ dB}$	-	10.9	-	dBm
RL_{in}	input return loss	$V_{ctrl(Gp)} = 0\text{ V}$ (maximum power gain)	-	19.3	-	dB
		$G_p = 17\text{ dB}$	-	22	-	dB
RL_{out}	output return loss	$V_{ctrl(Gp)} = 0\text{ V}$ (maximum power gain)	-	17.3	-	dB
K	Rollett stability factor	$0\text{ GHz} \leq f \leq 12.75\text{ GHz}$	1	-	-	

Table 9. Gain switch truth table

$V_{CC1} = 5\text{ V}$; $V_{CC2} = 5\text{ V}$; $-40\text{ }^\circ\text{C} \leq T_{amb} \leq +85\text{ }^\circ\text{C}$

Gain mode	GS1		GS2	
	logic	V_{GS1}	logic	V_{GS2}
high gain mode	LOW	0 V to 0.5 V	HIGH	2 V to 3.3 V
low gain mode	HIGH	2 V to 3.3 V	LOW	0 V to 0.5 V

8.1 Graphs

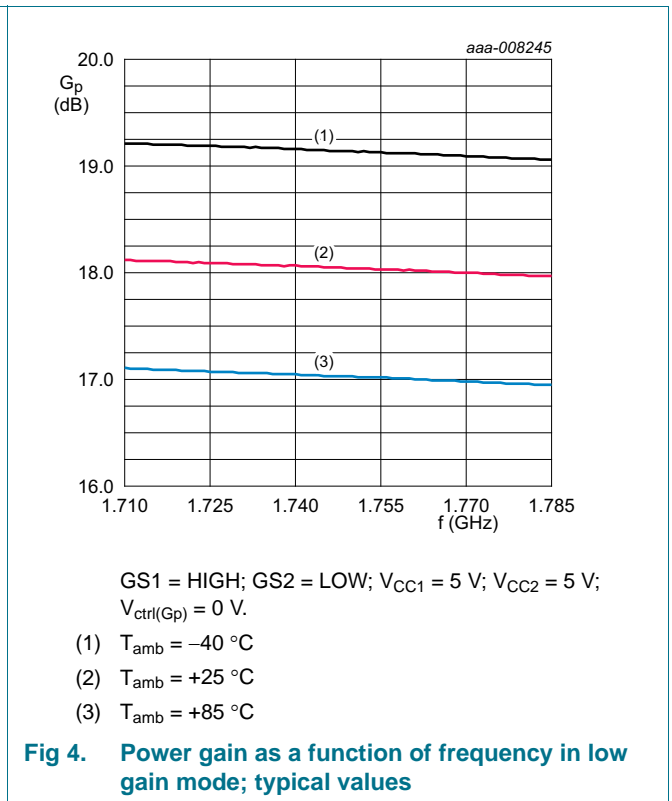
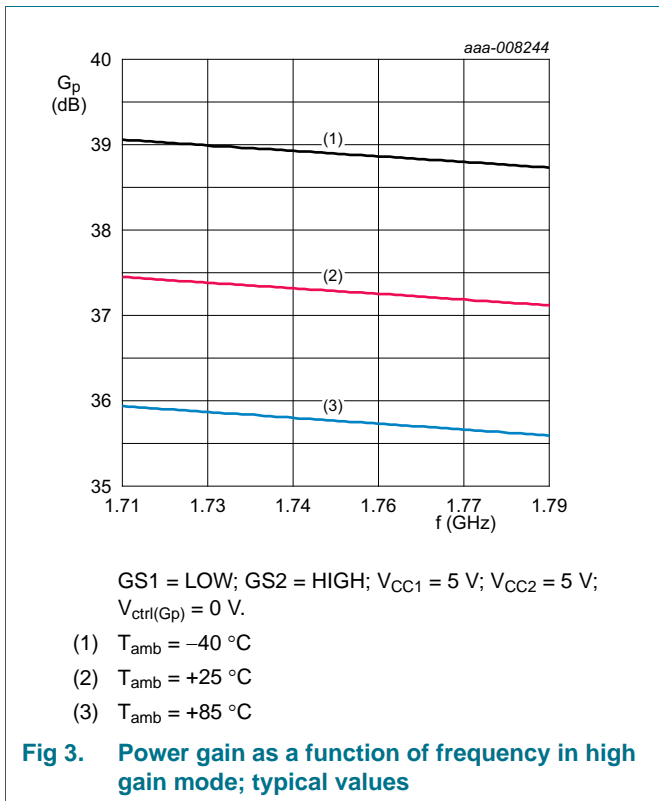

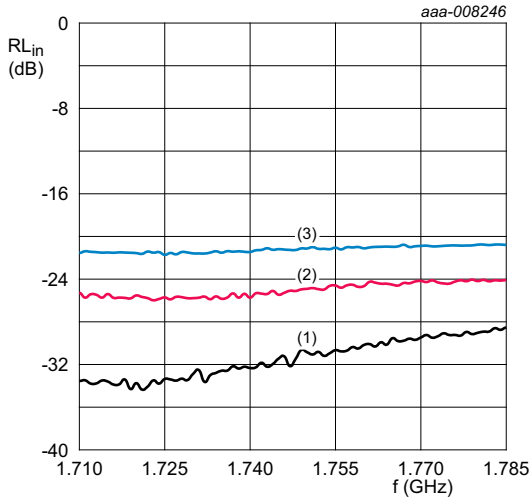

GS1 = LOW; GS2 = HIGH; $V_{CC1} = 5\text{ V}$; $V_{CC2} = 5\text{ V}$; $V_{ctrl(Gp)} = 0\text{ V}$.
 (1) $T_{amb} = -40\text{ }^{\circ}\text{C}$
 (2) $T_{amb} = +25\text{ }^{\circ}\text{C}$
 (3) $T_{amb} = +85\text{ }^{\circ}\text{C}$

Fig 5. Input return loss as a function of frequency in high gain mode; typical values

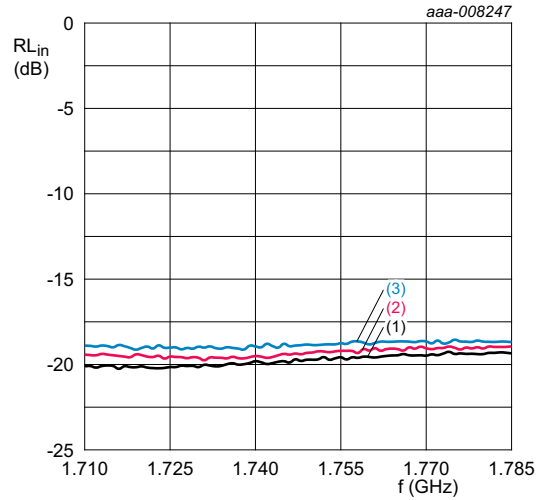

GS1 = HIGH; GS2 = LOW; $V_{CC1} = 5\text{ V}$; $V_{CC2} = 5\text{ V}$; $V_{ctrl(Gp)} = 0\text{ V}$.
 (1) $T_{amb} = -40\text{ }^{\circ}\text{C}$
 (2) $T_{amb} = +25\text{ }^{\circ}\text{C}$
 (3) $T_{amb} = +85\text{ }^{\circ}\text{C}$

Fig 6. Input return loss as a function of frequency in low gain mode; typical values

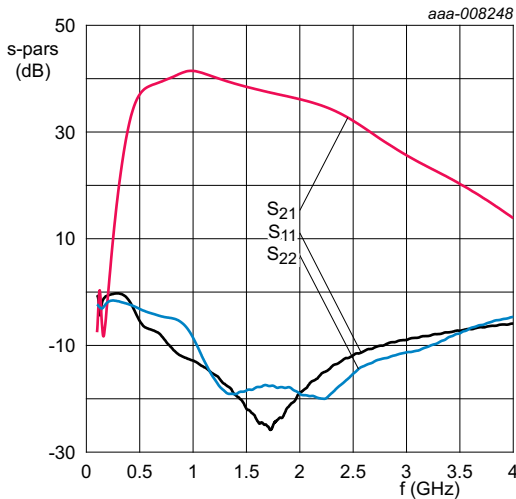

GS1 = LOW; GS2 = HIGH; $V_{CC1} = 5\text{ V}$; $V_{CC2} = 5\text{ V}$; $V_{ctrl(Gp)} = 0\text{ V}$; $T_{amb} = 25\text{ }^{\circ}\text{C}$.

Fig 7. S-parameters as a function of frequency in high gain mode; typical values

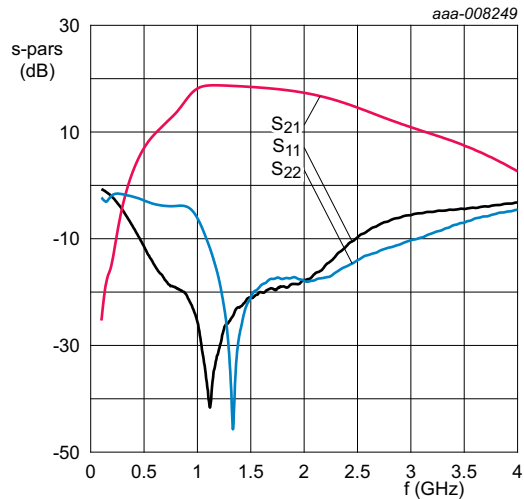

GS1 = HIGH; GS2 = LOW; $V_{CC1} = 5\text{ V}$; $V_{CC2} = 5\text{ V}$; $V_{ctrl(Gp)} = 0\text{ V}$; $T_{amb} = 25\text{ }^{\circ}\text{C}$.

Fig 8. S-parameters as a function of frequency in low gain mode; typical values

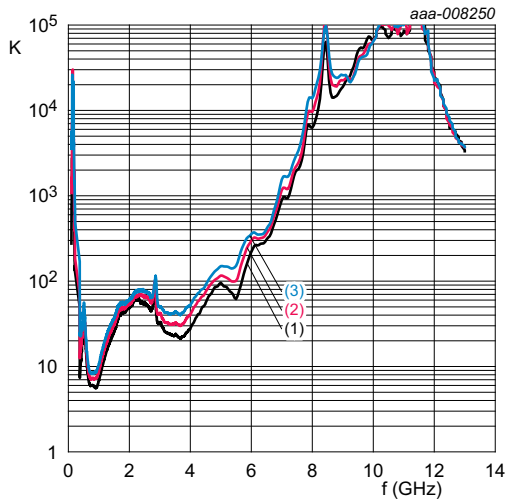

GS1 = LOW; GS2 = HIGH; $V_{CC1} = 5\text{ V}$; $V_{CC2} = 5\text{ V}$; $V_{ctrl}(G_p) = 0\text{ V}$.
 (1) $T_{amb} = -40\text{ }^\circ\text{C}$
 (2) $T_{amb} = +25\text{ }^\circ\text{C}$
 (3) $T_{amb} = +85\text{ }^\circ\text{C}$

Fig 9. Rollet stability factor as a function of frequency in high gain mode; typical values

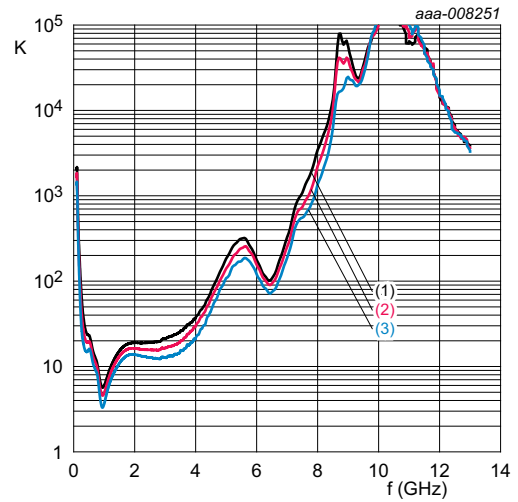

GS1 = HIGH; GS2 = LOW; $V_{CC1} = 5\text{ V}$; $V_{CC2} = 5\text{ V}$; $V_{ctrl}(G_p) = 0\text{ V}$.
 (1) $T_{amb} = -40\text{ }^\circ\text{C}$
 (2) $T_{amb} = +25\text{ }^\circ\text{C}$
 (3) $T_{amb} = +85\text{ }^\circ\text{C}$

Fig 10. Rollet stability factor as a function of frequency in low gain mode; typical values

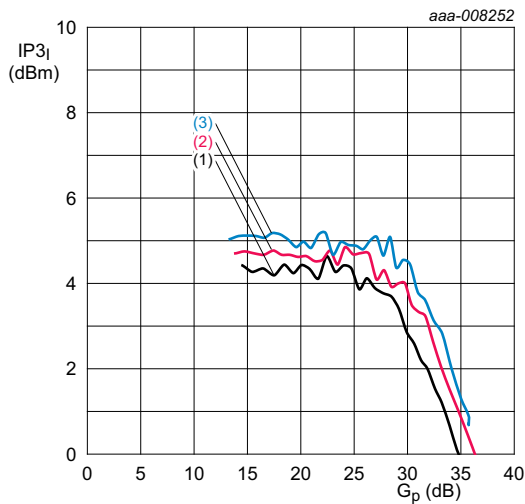

GS1 = LOW; GS2 = HIGH; $V_{CC1} = 5\text{ V}$; $V_{CC2} = 5\text{ V}$; $f = 1750\text{ MHz}$.
 (1) $T_{amb} = -40\text{ }^\circ\text{C}$
 (2) $T_{amb} = +25\text{ }^\circ\text{C}$
 (3) $T_{amb} = +85\text{ }^\circ\text{C}$

Fig 11. Input third-order intercept point as a function of power gain in high gain mode; typical values

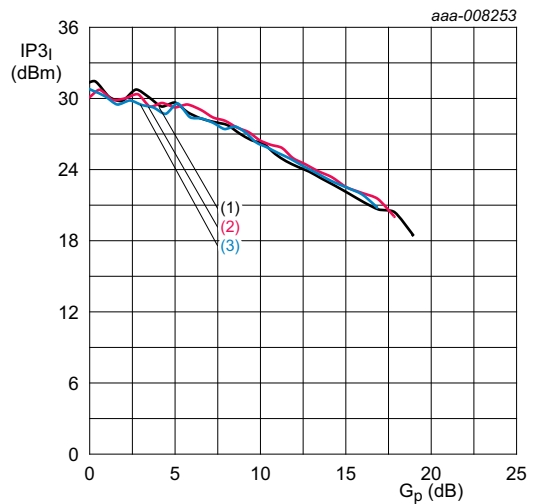

GS1 = HIGH; GS2 = LOW; $V_{CC1} = 5\text{ V}$; $V_{CC2} = 5\text{ V}$; $f = 1750\text{ MHz}$.
 (1) $T_{amb} = -40\text{ }^\circ\text{C}$
 (2) $T_{amb} = +25\text{ }^\circ\text{C}$
 (3) $T_{amb} = +85\text{ }^\circ\text{C}$

Fig 12. Input third-order intercept point as a function of power gain in low gain mode; typical values

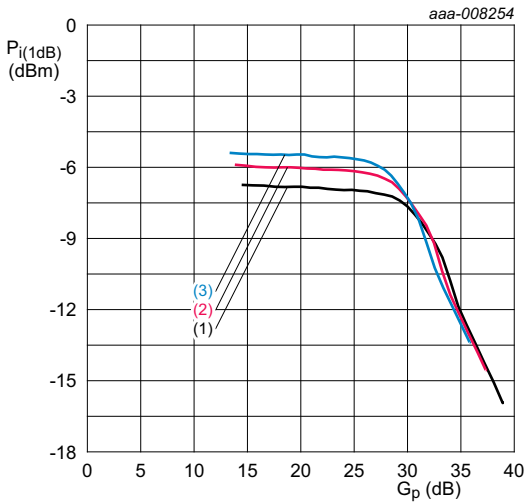

GS1 = LOW; GS2 = HIGH; $V_{CC1} = 5\text{ V}$; $V_{CC2} = 5\text{ V}$; $f = 1750\text{ MHz}$.
 (1) $T_{amb} = -40\text{ }^{\circ}\text{C}$
 (2) $T_{amb} = +25\text{ }^{\circ}\text{C}$
 (3) $T_{amb} = +85\text{ }^{\circ}\text{C}$

Fig 13. Input power at 1 dB gain compression as a function of power gain in high gain mode; typical values

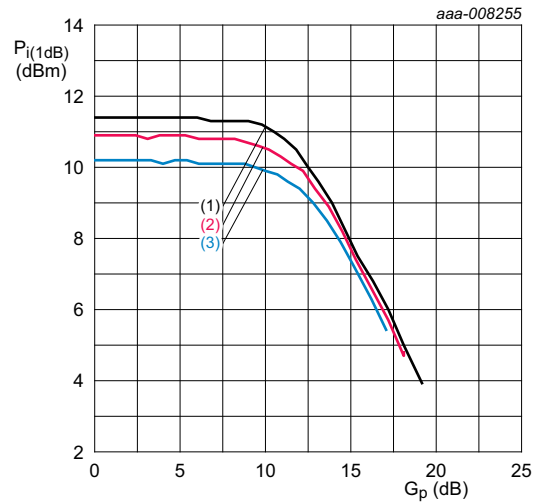

GS1 = HIGH; GS2 = LOW; $V_{CC1} = 5\text{ V}$; $V_{CC2} = 5\text{ V}$; $f = 1750\text{ MHz}$.
 (1) $T_{amb} = -40\text{ }^{\circ}\text{C}$
 (2) $T_{amb} = +25\text{ }^{\circ}\text{C}$
 (3) $T_{amb} = +85\text{ }^{\circ}\text{C}$

Fig 14. Input power at 1 dB gain compression as a function of power gain in low gain mode; typical values

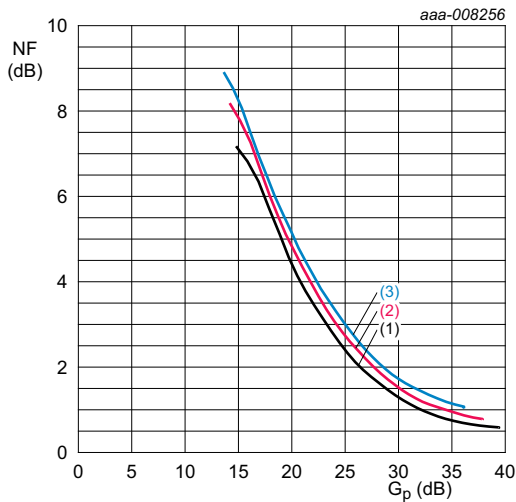

GS1 = LOW; GS2 = HIGH; $V_{CC1} = 5\text{ V}$; $V_{CC2} = 5\text{ V}$; $f = 1750\text{ MHz}$.
 (1) $T_{amb} = -40\text{ }^{\circ}\text{C}$
 (2) $T_{amb} = +25\text{ }^{\circ}\text{C}$
 (3) $T_{amb} = +85\text{ }^{\circ}\text{C}$

Fig 15. Noise figure as a function of power gain in high gain mode; typical values

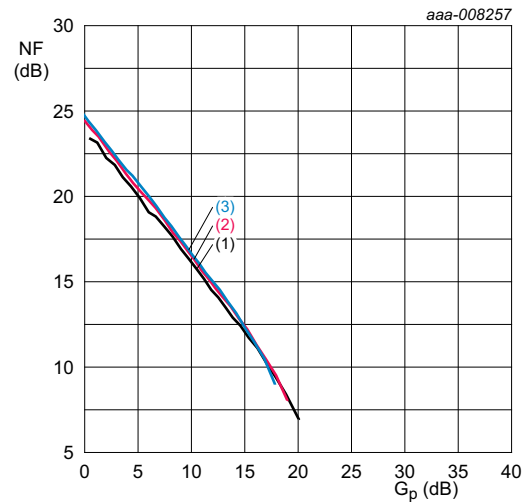

GS1 = HIGH; GS2 = LOW; $V_{CC1} = 5\text{ V}$; $V_{CC2} = 5\text{ V}$; $f = 1750\text{ MHz}$.
 (1) $T_{amb} = -40\text{ }^{\circ}\text{C}$
 (2) $T_{amb} = +25\text{ }^{\circ}\text{C}$
 (3) $T_{amb} = +85\text{ }^{\circ}\text{C}$

Fig 16. Noise figure as a function of power gain in low gain mode; typical values

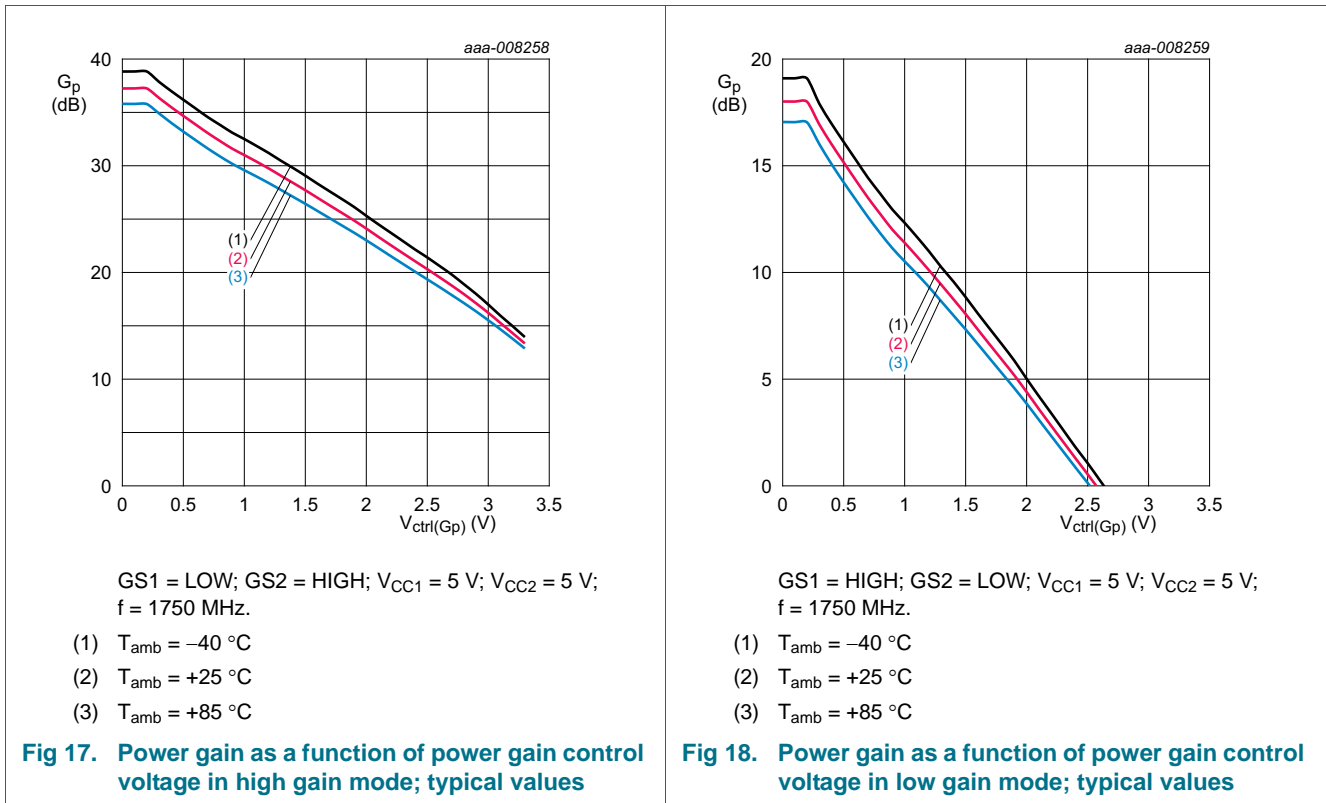

9. Application information

Table 10. List of components
 For application circuit see [Figure 19](#).

Component	Description	Value	Remarks
C1, C2	capacitor	1 nF	[1] 0402
C3, C4, C5, C6, C12	capacitor	100 pF	[1] 0402
C7, C8, C9, C10,	capacitor	optional	
C11, C17	capacitor	100 nF	[1] 0402
C13, C14, C15, C16	capacitor	optional	
L1, L2	inductor	10 nH	[2] 0402

[1] Murata GRM1555 series.
 [2] Murata LQG15 series.

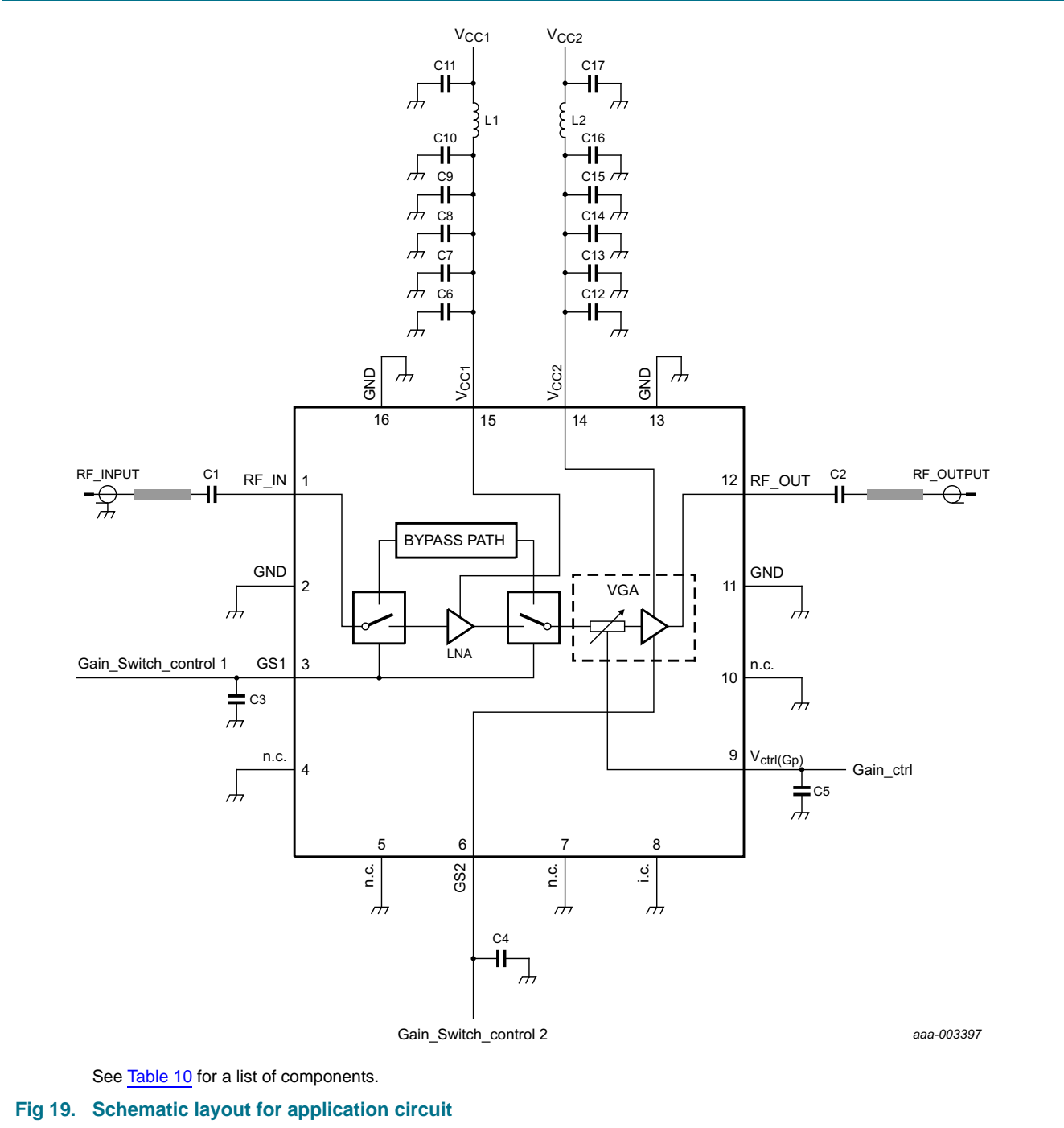

10. Package outline

HLQFN16R: plastic thermal enhanced low profile quad flat package; no leads; 16 terminals; body 8 x 8 x 1.3 mm SOT1301-1

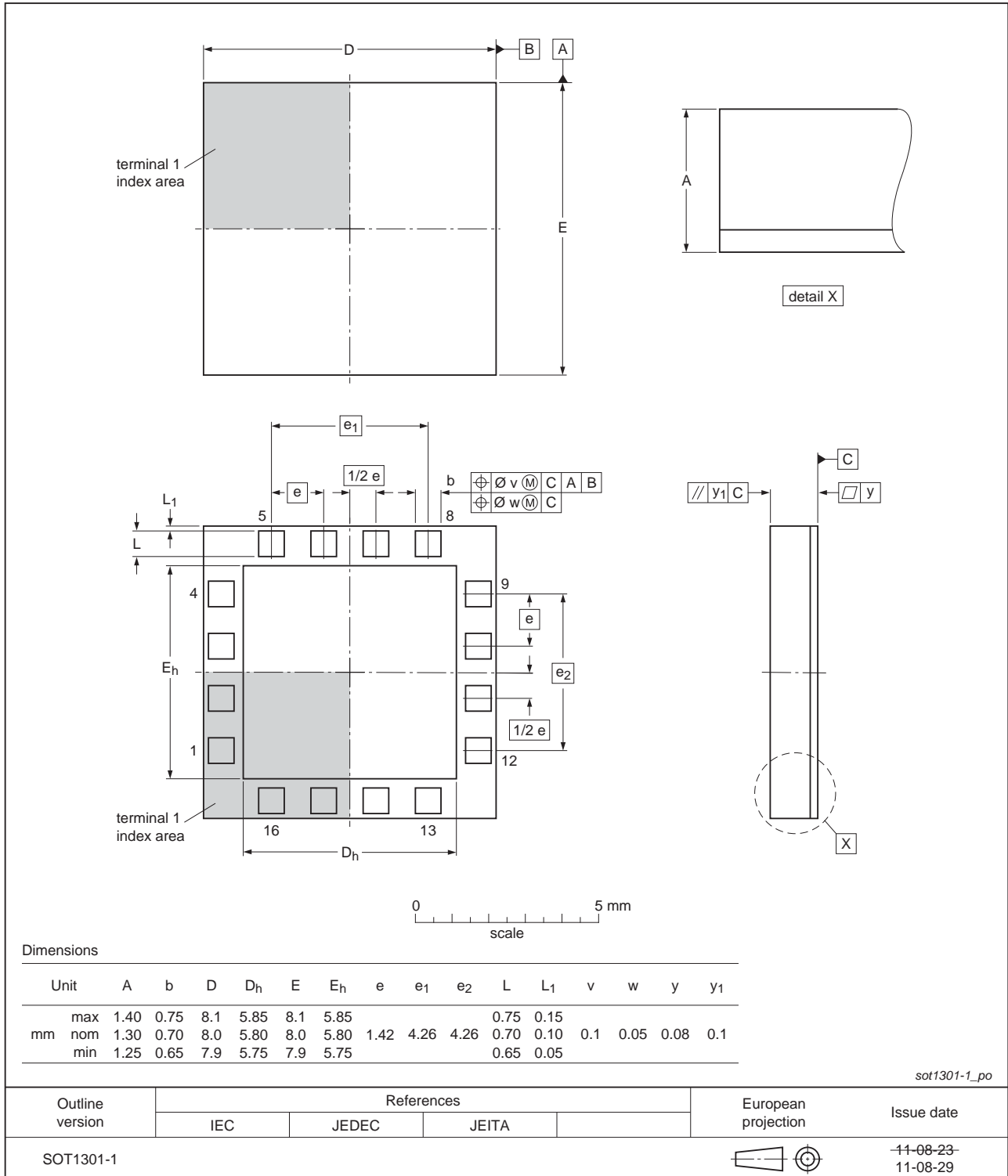

Fig 20. Package outline SOT1301-1 (HLQFN16R)

11. Abbreviations

Table 11. Abbreviations

Acronym	Description
3G	3rd Generation
ESD	ElectroStatic Discharge
LNA	Low Noise Amplifier
LTE	Long Term Evolution

12. Revision history

Table 12. Revision history

Document ID	Release date	Data sheet status	Change notice	Supersedes
BGU7062N2 v.1	20130708	Product data sheet	-	-

13. Legal information

13.1 Data sheet status

Document status ^{[1][2]}	Product status ^[3]	Definition
Objective [short] data sheet	Development	This document contains data from the objective specification for product development.
Preliminary [short] data sheet	Qualification	This document contains data from the preliminary specification.
Product [short] data sheet	Production	This document contains the product specification.

[1] Please consult the most recently issued document before initiating or completing a design.

[2] The term 'short data sheet' is explained in section "Definitions".

[3] The product status of device(s) described in this document may have changed since this document was published and may differ in case of multiple devices. The latest product status information is available on the Internet at URL <http://www.nxp.com>.

13.2 Definitions

Draft — The document is a draft version only. The content is still under internal review and subject to formal approval, which may result in modifications or additions. NXP Semiconductors does not give any representations or warranties as to the accuracy or completeness of information included herein and shall have no liability for the consequences of use of such information.

Short data sheet — A short data sheet is an extract from a full data sheet with the same product type number(s) and title. A short data sheet is intended for quick reference only and should not be relied upon to contain detailed and full information. For detailed and full information see the relevant full data sheet, which is available on request via the local NXP Semiconductors sales office. In case of any inconsistency or conflict with the short data sheet, the full data sheet shall prevail.

Product specification — The information and data provided in a Product data sheet shall define the specification of the product as agreed between NXP Semiconductors and its customer, unless NXP Semiconductors and customer have explicitly agreed otherwise in writing. In no event however, shall an agreement be valid in which the NXP Semiconductors product is deemed to offer functions and qualities beyond those described in the Product data sheet.

13.3 Disclaimers

Limited warranty and liability — Information in this document is believed to be accurate and reliable. However, NXP Semiconductors does not give any representations or warranties, expressed or implied, as to the accuracy or completeness of such information and shall have no liability for the consequences of use of such information. NXP Semiconductors takes no responsibility for the content in this document if provided by an information source outside of NXP Semiconductors.

In no event shall NXP Semiconductors be liable for any indirect, incidental, punitive, special or consequential damages (including - without limitation - lost profits, lost savings, business interruption, costs related to the removal or replacement of any products or rework charges) whether or not such damages are based on tort (including negligence), warranty, breach of contract or any other legal theory.

Notwithstanding any damages that customer might incur for any reason whatsoever, NXP Semiconductors' aggregate and cumulative liability towards customer for the products described herein shall be limited in accordance with the *Terms and conditions of commercial sale* of NXP Semiconductors.

Right to make changes — NXP Semiconductors reserves the right to make changes to information published in this document, including without limitation specifications and product descriptions, at any time and without notice. This document supersedes and replaces all information supplied prior to the publication hereof.

Suitability for use — NXP Semiconductors products are not designed, authorized or warranted to be suitable for use in life support, life-critical or safety-critical systems or equipment, nor in applications where failure or malfunction of an NXP Semiconductors product can reasonably be expected to result in personal injury, death or severe property or environmental damage. NXP Semiconductors and its suppliers accept no liability for inclusion and/or use of NXP Semiconductors products in such equipment or applications and therefore such inclusion and/or use is at the customer's own risk.

Applications — Applications that are described herein for any of these products are for illustrative purposes only. NXP Semiconductors makes no representation or warranty that such applications will be suitable for the specified use without further testing or modification.

Customers are responsible for the design and operation of their applications and products using NXP Semiconductors products, and NXP Semiconductors accepts no liability for any assistance with applications or customer product design. It is customer's sole responsibility to determine whether the NXP Semiconductors product is suitable and fit for the customer's applications and products planned, as well as for the planned application and use of customer's third party customer(s). Customers should provide appropriate design and operating safeguards to minimize the risks associated with their applications and products.

NXP Semiconductors does not accept any liability related to any default, damage, costs or problem which is based on any weakness or default in the customer's applications or products, or the application or use by customer's third party customer(s). Customer is responsible for doing all necessary testing for the customer's applications and products using NXP Semiconductors products in order to avoid a default of the applications and the products or of the application or use by customer's third party customer(s). NXP does not accept any liability in this respect.

Limiting values — Stress above one or more limiting values (as defined in the Absolute Maximum Ratings System of IEC 60134) will cause permanent damage to the device. Limiting values are stress ratings only and (proper) operation of the device at these or any other conditions above those given in the Recommended operating conditions section (if present) or the Characteristics sections of this document is not warranted. Constant or repeated exposure to limiting values will permanently and irreversibly affect the quality and reliability of the device.

Terms and conditions of commercial sale — NXP Semiconductors products are sold subject to the general terms and conditions of commercial sale, as published at <http://www.nxp.com/profile/terms>, unless otherwise agreed in a valid written individual agreement. In case an individual agreement is concluded only the terms and conditions of the respective agreement shall apply. NXP Semiconductors hereby expressly objects to applying the customer's general terms and conditions with regard to the purchase of NXP Semiconductors products by customer.

No offer to sell or license — Nothing in this document may be interpreted or construed as an offer to sell products that is open for acceptance or the grant, conveyance or implication of any license under any copyrights, patents or other industrial or intellectual property rights.

Export control — This document as well as the item(s) described herein may be subject to export control regulations. Export might require a prior authorization from competent authorities.

Quick reference data — The Quick reference data is an extract of the product data given in the Limiting values and Characteristics sections of this document, and as such is not complete, exhaustive or legally binding.

Non-automotive qualified products — Unless this data sheet expressly states that this specific NXP Semiconductors product is automotive qualified, the product is not suitable for automotive use. It is neither qualified nor tested in accordance with automotive testing or application requirements. NXP Semiconductors accepts no liability for inclusion and/or use of non-automotive qualified products in automotive equipment or applications.

In the event that customer uses the product for design-in and use in automotive applications to automotive specifications and standards, customer (a) shall use the product without NXP Semiconductors' warranty of the

product for such automotive applications, use and specifications, and (b) whenever customer uses the product for automotive applications beyond NXP Semiconductors' specifications such use shall be solely at customer's own risk, and (c) customer fully indemnifies NXP Semiconductors for any liability, damages or failed product claims resulting from customer design and use of the product for automotive applications beyond NXP Semiconductors' standard warranty and NXP Semiconductors' product specifications.

Translations — A non-English (translated) version of a document is for reference only. The English version shall prevail in case of any discrepancy between the translated and English versions.

13.4 Trademarks

Notice: All referenced brands, product names, service names and trademarks are the property of their respective owners.

14. Contact information

For more information, please visit: <http://www.nxp.com>

For sales office addresses, please send an email to: salesaddresses@nxp.com

15. Contents

1 Product profile 1

1.1 General description 1

1.2 Features and benefits 1

1.3 Applications 1

1.4 Quick reference data 2

2 Pinning information 2

2.1 Pinning 2

2.2 Pin description 2

3 Ordering information 3

4 Functional diagram 3

5 Limiting values 4

6 Recommended operating conditions 4

7 Thermal characteristics 4

8 Characteristics 5

8.1 Graphs 6

9 Application information 10

10 Package outline 12

11 Abbreviations 13

12 Revision history 13

13 Legal information 14

13.1 Data sheet status 14

13.2 Definitions 14

13.3 Disclaimers 14

13.4 Trademarks 15

14 Contact information 15

15 Contents 16

Please be aware that important notices concerning this document and the product(s) described herein, have been included in section 'Legal information'.

© NXP B.V. 2013. All rights reserved.

For more information, please visit: <http://www.nxp.com>
 For sales office addresses, please send an email to: salesaddresses@nxp.com

Date of release: 8 July 2013
 Document identifier: BGU7062N2