



Demonstration and Evaluation Boards

Interface Products
Aug 2007



Evaluation/Demo Board List

OM#	Description
OM6270	SPI/I ² C to UART Bridge Demoboard (SC16IS750)
OM6271	SPI to I ² C Master Bridge Demoboard (SC18IS600)
OM6272	UART to I ² C Master Bridge Demoboard (SC18IM700)
OM6273	SPI/I ² C to Dual UART/IRDA/GPIO Demoboard (SC16IS752)
OM6275	I2C 2005-1 Demo Board (15 I ² C devices w/USB control & GUI)
OM6276	PCA9633 Demo Board (Four Color PWM LED Control)
OM6277	PCA9564 Eval Board (I ² C Master)
OM6278	I2C 2002-1A Eval Board (11 I ² C devices w/printer port control & GUI)
OM6279	LED Dimmer Demo Board
OM6285	I2C 2002-1A Eval Board (without/printer port control & GUI)
OM10088	PCF8562 LCD Segment Display

More information: www.standardics.nxp.com/support/boards

Contact us: interface.support@nxp.com or i2c.support@nxp.com



Experience the variety of I²C peripherals with the latest I²C Training Board

- ▶ Fifteen different I²C devices on one board allows easy experimentation and training. (PCA9531, PCA9536, PCA9538, PCA9540B, PCA9541, PCA9543A, PCA9551, PCF8563, PCF8574, PCF85116-3, SA56004, SE98)
- ▶ Add Extra I/O Ports, Temperature Sensors, LED Drivers, Real-time Clock, I²C Bus Switching
- ▶ USB Connection to trial version (only devices on board and that fixed address is operational) Graphics Interface for Windows PC/Laptop
- ▶ www.standardics.nxp.com/support/boards/i2c20051/
- ▶ Target Board & USB based GUI (400 kHz) #OM6275

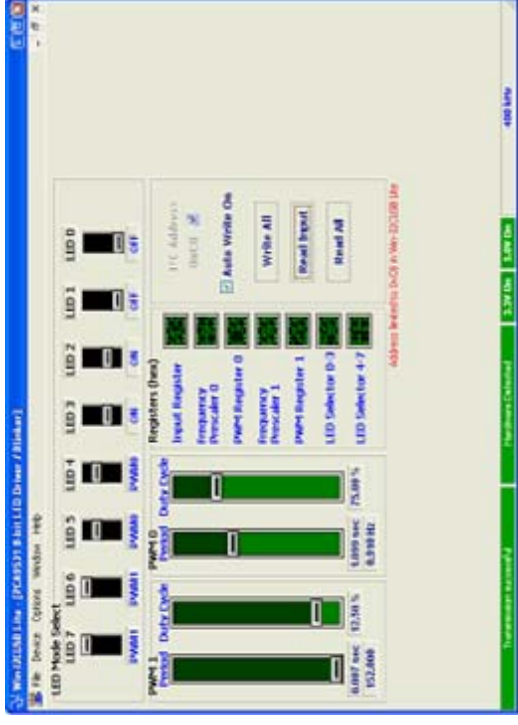

Get the color right with the single chip four color LED driver (R G B ?)

- ▶ Individual PWM for each component color,
– 25 mA per pin
- ▶ Global PWM, to set your perfect overall brightness or blink LEDs
- ▶ I²C interface for easy connection to Micro or Baseband IC
– High drive on I²C bus for multiple devices or long distances

▶ www.standaedics.nxp.com/support/boards/pca9633/

- ▶ Demo Board with on board micro #**OM6276**
 - Highlights PCA9633 and LPC900 MCU
 - On-board FETs can sink 300mA per LED

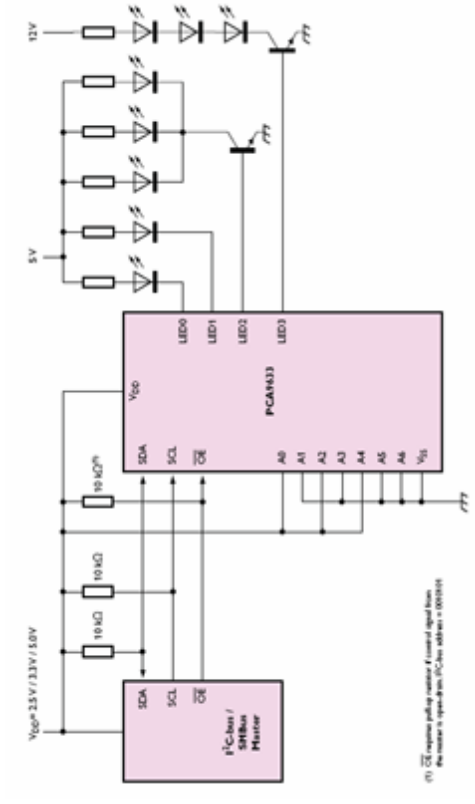
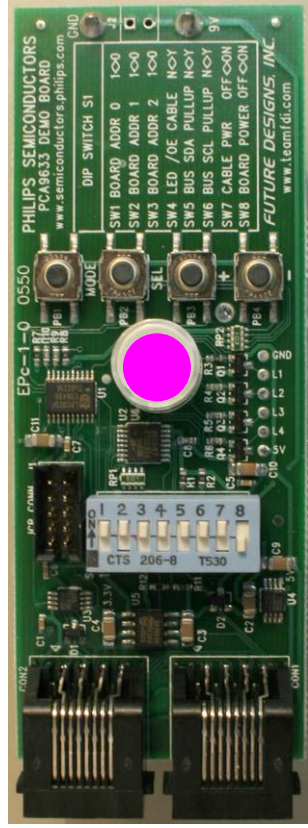

Blink an LED without bit banging

Dim and LED with burning a PWM on the MCU

- ▶ Two PWMs to map across 2,4,8,16 outputs
 - 25 mA per pin
- ▶ I²C interface for easy connection to Micro or Baseband IC
- ▶ Demo Board with on board micro #**OM6279**
 - PCA9533, PCA9531
 - On-board NXP MCU demonstrates capabilities
 - www.standaards.nxp.com/support/boards/leddemo

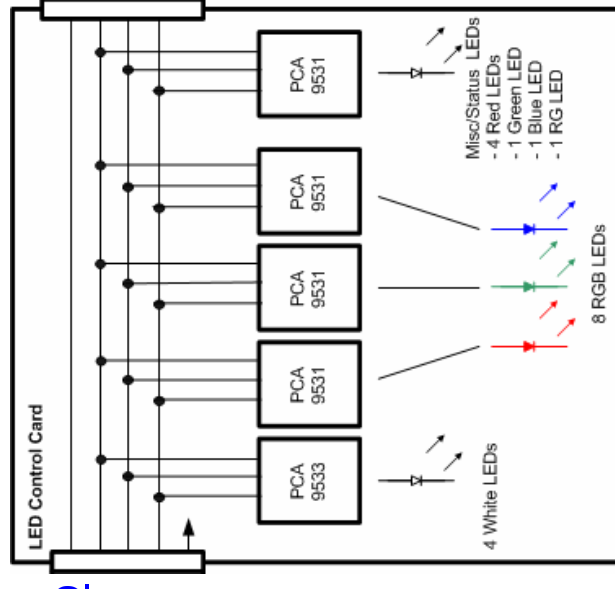
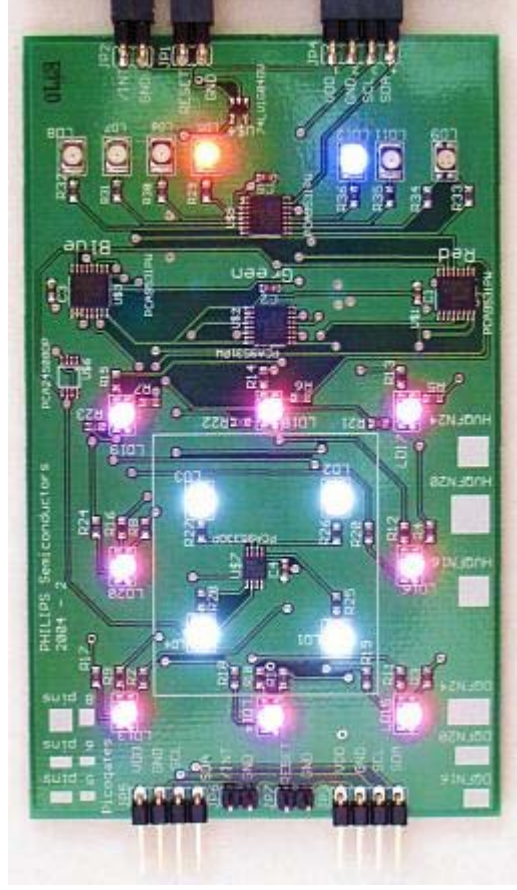

Easily drive a LCD Segment Display with a very small MCU and PCF8562

- ▶ Good for a User Interface at the front panel of a system
- ▶ Scalable to match the complexity of the LCD display
- ▶ Simple code using industry-standard 8051 core
- ▶ Easily reprogram micro via USB adapter (#OM10083)
- ▶ <http://www.teamfdi.com/products/lcddemo.shtml>
- ▶ Demo Board with on board micro #OM10088

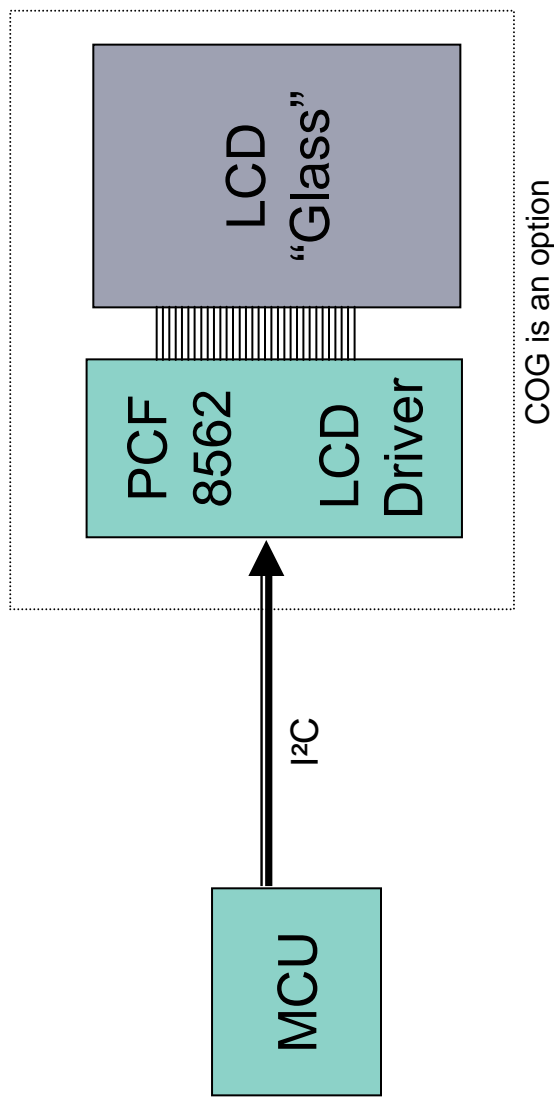
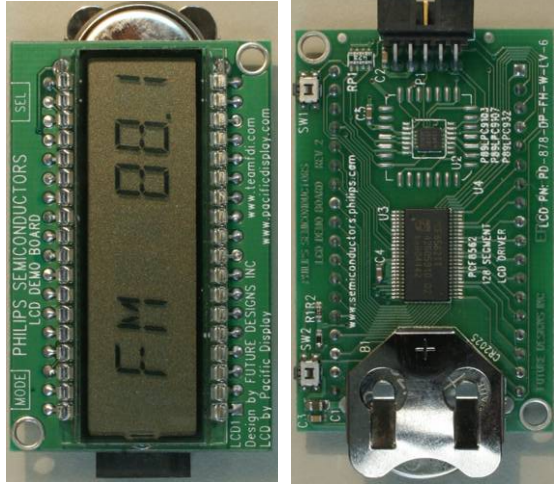

Need a “fresh” I²C Master ?

NXP has three different options.

- ▶ Connect to a MCU’s 8-bit peripheral port
 - PCA9564 I²C Bus Controller
 - <http://www.standardics.nxp.com/support/boards/pca9564/>
 - Demo Board with two on board micros #**OM6277**
- ▶ Connect to a MCU’s SPI port
 - SC18IS600 SPI to I²C Master + GPIO Bridge
 - Demo Board #**OM6271**
- ▶ Connect to an extra Async port from MCU or Single Board Computer or ?
 - SC18IM700 Async to I²C Master + GPIO Bridge
 - Demo Board #**OM6272**

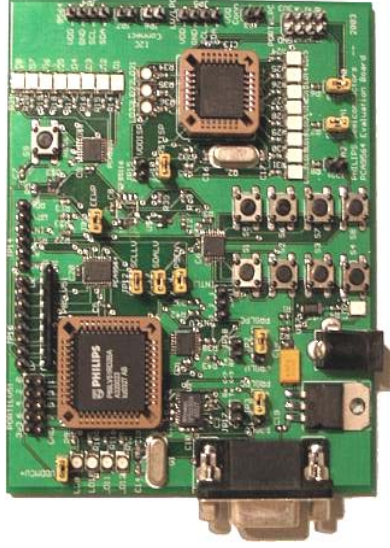

8 bit to I²C Bus Controller

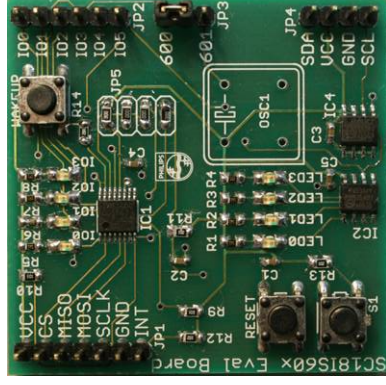

SPI to I²C Master



Async to I²C Master

Break out of “Pin Mux Jail” Use what you have to make what you need

- ▶ Add new Async ports using available interfaces on MCUs, ASSPs, SoCs
- ▶ Code examples for NXP ARM7 MCUs
- ▶ Fast! Up to 5Mbps... perfect for Bluetooth 2.0 w/EDR
- ▶ Connects to MCU as a I²C Slave or SPI Slave
- ▶ Many add extra General Purpose I/O
- ▶ Dual Channel Demo Board #**OM6273**
 - Features SC16IS752
- ▶ Single Channel Demo Board #**OM6270**
 - Features SC16IS750

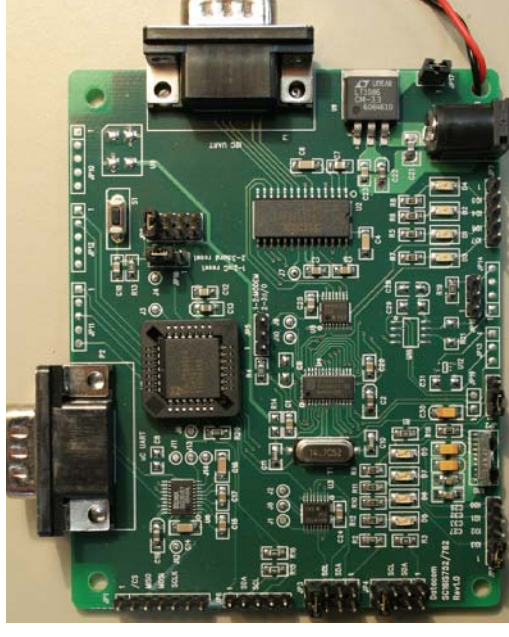

I²C or SPI to Dual Async incl. RS-485 Support

www.standardics.nxp.com/support/boards/sc16is7xx/



Train on many I²C peripherals using parallel printer port to PC

- ▶ Eleven different I²C devices on one board allows easy experimentation and training (LM75A, P82B96/PCA9600, PCA9501, PCA9515, PCA9543, PCA9550, PCA9551, PCA9554, PCA9555, PCA9561, PCA9562, PCA9563)
- ▶ Add Extra I/O Ports, Temperature Sensors, LED Drivers, I²C Bus Switching
- ▶ I²C Bus adapter uses parallel printer port for connection to full version (all devices and addresses operational) of Graphics Interface for Windows PC/Laptop
- ▶ www.standardics.nxp.com/support/boards/i2c20021/
- ▶ Target Board plus parallel printer port control (100 kHz) & GUI #OM6278
- ▶ Target Board only #OM6285

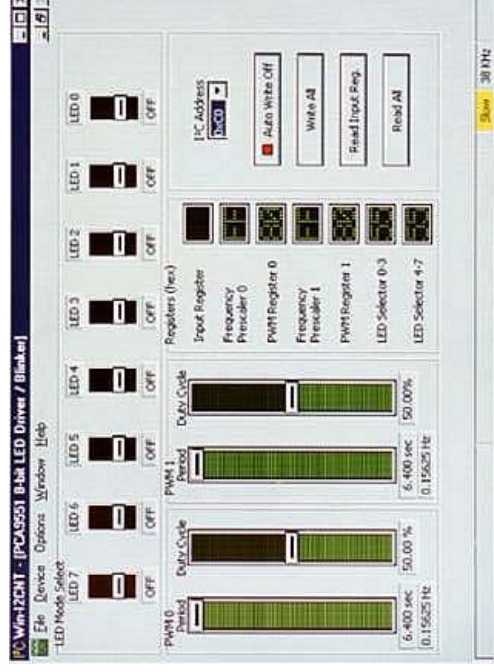

Product focus – UART/I²C/SPI Bridge

- ▶ New generation of interface solutions for managing communication among various bus interfaces
- ▶ Purpose : Overcome the limitation of the host bus interface to peripherals

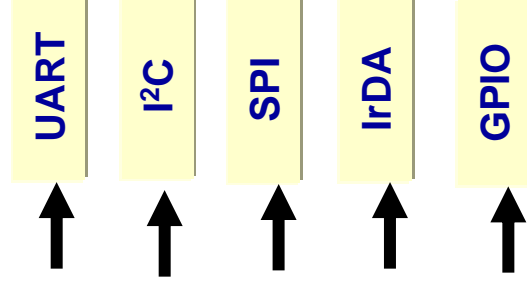
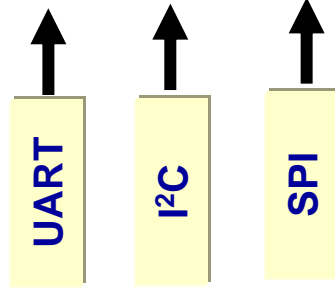

- ▶ Benefit :
 - Greater design flexibility
 - Ability to retain original design investment
 - Faster time to market
 - Link legacy and new systems and vice versa

NXP Bridge

Leading in
miniaturisation
high speed
low power

Competitive advantages:

- First in the market with broad portfolio of high speed serial bridge solutions.
- Soul sourced on most products
- Small packaging (4x4 HVQFN) ideal for handheld
- Low power
- Industrial Temperature at commercial pricing

Customer benefits:

- Serial (SPI/I2C/UART) interface simplifies host connection.
- Greater design flexibility
- Ability to retain original design investment
- Faster time to market
- Link legacy and new systems and vice versa
- Additional GPIO provides broader usage of ports.

Ideal for:





- All types of applications
- Wherever UART/SPI or I2C port expansion is required
- Protocol conversion
- Link legacy and new systems
- Mobile Handheld, GPS, PDP, Telecom Networking, Satellite radio, Car Infotainment

Product highlights:

- New : SC16IS602 : I2C to SPI master and GPIO.
- New : WinCE driver for SC16IS7xx bridges



NXP Bridge IC – Demo Board Kits

I2C/SPI slave to UART SC16IS7xx	UART to I2C master SC18IM700	SPI to I2C master SC18IS600	I2C to SPI master SC18IS602
 <p>Kits include</p> <ul style="list-style-type: none"> • Sample code: RS232, RS485, and IrDA • User Manual <p>Key Benefit</p> <p>Easy interface to I2C/SPI host and IrDA, RS232/RS485, and GPIO devices. Selectable I2C or SPI-bus interface</p>	 <p>Kits include</p> <ul style="list-style-type: none"> • Sample code: RS232 and NXP I2C devices • User Manual <p>Key Benefit</p> <p>Easy interface to UART host and various I2C and GPIO devices. On-board I2C EEPROM and I2C LED Dimmer</p>	 <p>Kits include</p> <ul style="list-style-type: none"> • Sample code: SPI and NXP I2C devices • User Manual <p>Key Benefit</p> <p>Easy interface to SPI host and various I2C and GPIO devices. On-board I2C EEPROM and I2C LED Dimmer</p>	 <p>Kits include</p> <ul style="list-style-type: none"> • Sample code: I2C and NXP SPI devices • User Manual <p>Key Benefit</p> <p>Easy interface to I2C host and SPI and GPIO devices. Up to 4 SPI chip selects</p>
<p>OM6270 – SC16IS750 OM6273 – SC16IS752</p>	<p>OM6271</p>	<p>OM6272</p>	<p>OM6274</p>



