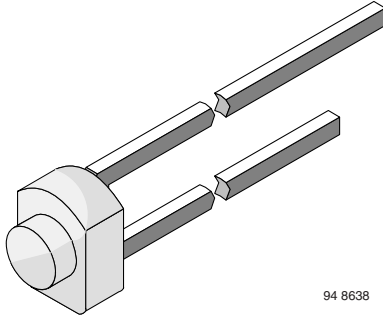


Silicon NPN Phototransistor



FEATURES

- Package type: leaded
- Package form: T- $\frac{3}{4}$
- Dimensions (in mm): \varnothing 1.8
- High photo sensitivity
- High radiant sensitivity
- Suitable for visible and near infrared radiation
- Fast response times
- Angle of half sensitivity: $\phi = \pm 40^\circ$
- Compliant to RoHS Directive 2002/95/EC and in accordance to WEEE 2002/96/EC



Note

** Please see document "Vishay Material Category Policy":
www.vishay.com/doc?99902

APPLICATIONS

- Detector in electronic control and drive circuits

DESCRIPTION

BPW16N is a silicon NPN phototransistor with high radiant sensitivity in clear, T- $\frac{3}{4}$ plastic package with flat window. It is sensitive to visible and near infrared radiation. On PCB this package size enables assembly of arrays with 2.54 mm pitch.

PRODUCT SUMMARY			
COMPONENT	I_{ca} (mA)	ϕ (deg)	$\lambda_{0.1}$ (nm)
BPW16N	0.14	± 40	450 to 1040

Note

- Test condition see table "Basic Characteristics"

ORDERING INFORMATION			
ORDERING CODE	PACKAGING	REMARKS	PACKAGE FORM
BPW16N	Bulk	MOQ: 5000 pcs, 5000 pcs/bulk	T- $\frac{3}{4}$

Note

- MOQ: minimum order quantity

ABSOLUTE MAXIMUM RATINGS ($T_{amb} = 25^\circ\text{C}$, unless otherwise specified)				
PARAMETER	TEST CONDITION	SYMBOL	VALUE	UNIT
Collector emitter voltage		V_{CEO}	32	V
Emitter collector voltage		V_{ECO}	5	V
Collector current		I_C	50	mA
Collector peak current	$t_p/T = 0.5, t_p \leq 10 \text{ ms}$	I_{CM}	100	mA
Power dissipation	$T_{amb} \leq 55^\circ\text{C}$	P_V	100	mW
Junction temperature		T_j	100	$^\circ\text{C}$
Operating temperature range		T_{amb}	- 40 to + 100	$^\circ\text{C}$
Storage temperature range		T_{stg}	- 40 to + 100	$^\circ\text{C}$
Soldering temperature	$t \leq 3 \text{ s}$	T_{sd}	260	$^\circ\text{C}$
Thermal resistance junction/ambient	Connected with Cu wire, 0.14 mm ²	R_{thJA}	450	K/W

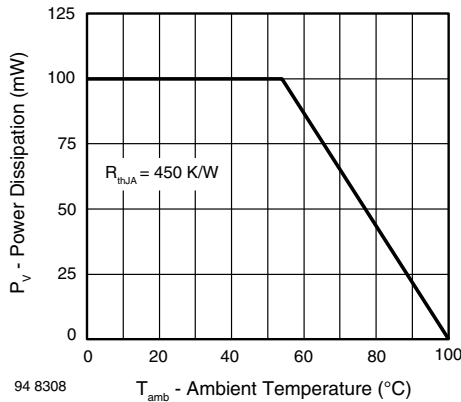


Fig. 1 - Power Dissipation Limit vs. Ambient Temperature

BASIC CHARACTERISTICS (T _{amb} = 25 °C, unless otherwise specified)						
PARAMETER	TEST CONDITION	SYMBOL	MIN.	TYP.	MAX.	UNIT
Collector emitter breakdown voltage	I _C = 1 mA	V _{(BR)CEO}	32			V
Collector emitter dark current	V _{CE} = 20 V, E = 0	I _{CEO}		1	200	nA
Collector emitter capacitance	V _{CE} = 5 V, f = 1 MHz, E = 0	C _{CEO}		8		pF
Collector light current	E _e = 1 mW/cm ² , λ = 950 nm, V _{CE} = 5 V	I _{ca}	0.07	0.14		mA
Angle of half sensitivity		φ		± 40		deg
Wavelength of peak sensitivity		λ _p		825		nm
Range of spectral bandwidth		λ _{0.1}		450 to 1040		nm
Collector emitter saturation voltage	E _e = 1 mW/cm ² , λ = 950 nm, I _C = 0.01 mA	V _{CEsat}			0.3	V
Turn-on time	V _S = 5 V, I _C = 5 mA, R _L = 100 Ω	t _{on}		4.8		μs
Turn-off time	V _S = 5 V, I _C = 5 mA, R _L = 100 Ω	t _{off}		5.0		μs
Cut-off frequency	V _S = 5 V, I _C = 5 mA, R _L = 100 Ω	f _c		120		kHz

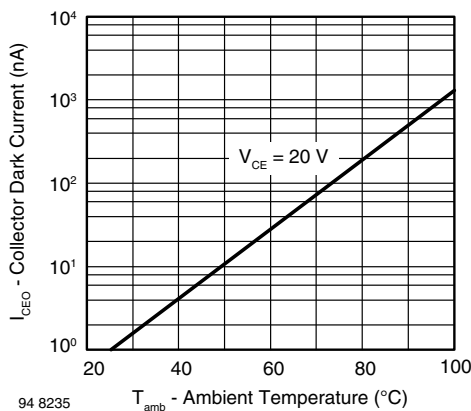
BASIC CHARACTERISTICS (T_{amb} = 25 °C, unless otherwise specified)


Fig. 1 - Collector Dark Current vs. Ambient Temperature

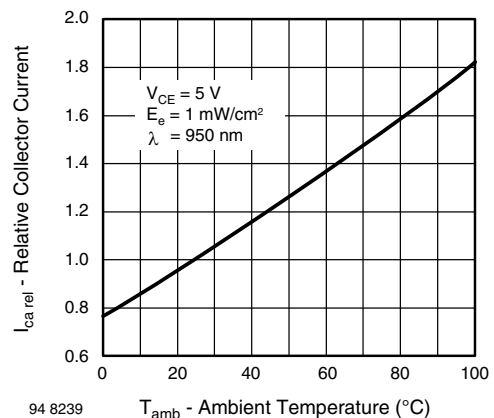
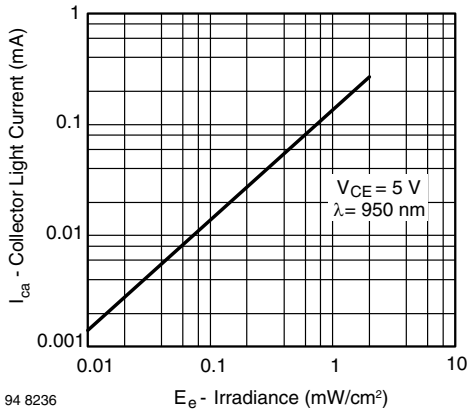
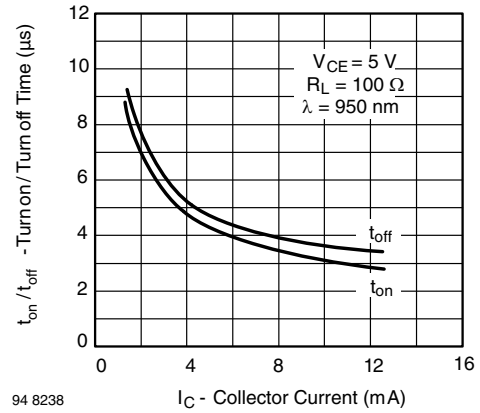


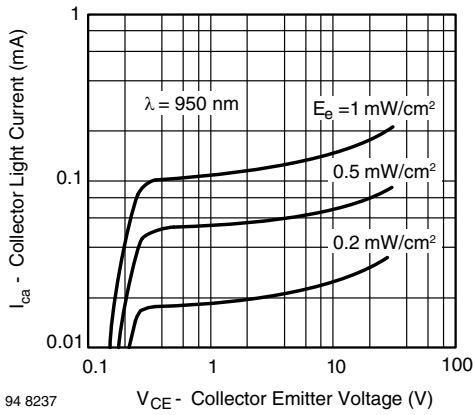
Fig. 2 - Relative Collector Current vs. Ambient Temperature



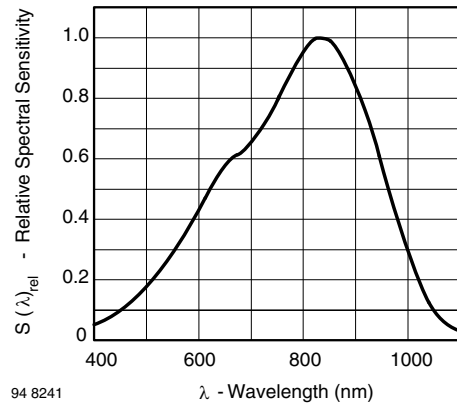
94 8236
Fig. 3 - Collector Light Current vs. Irradiance



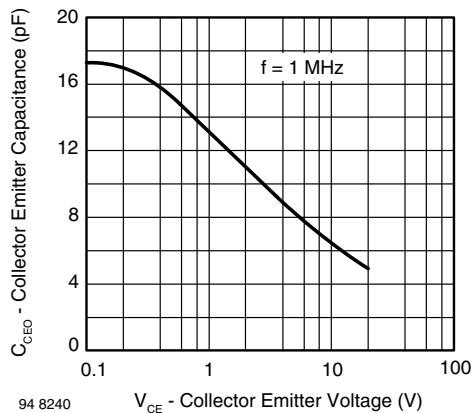
94 8238
Fig. 6 - Turn-on/Turn-off Time vs. Collector Current



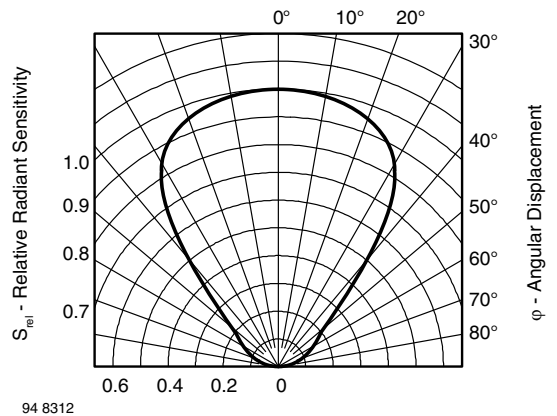
94 8237
Fig. 4 - Collector Light Current vs. Collector Emitter Voltage



94 8241
Fig. 7 - Relative Spectral Sensitivity vs. Wavelength



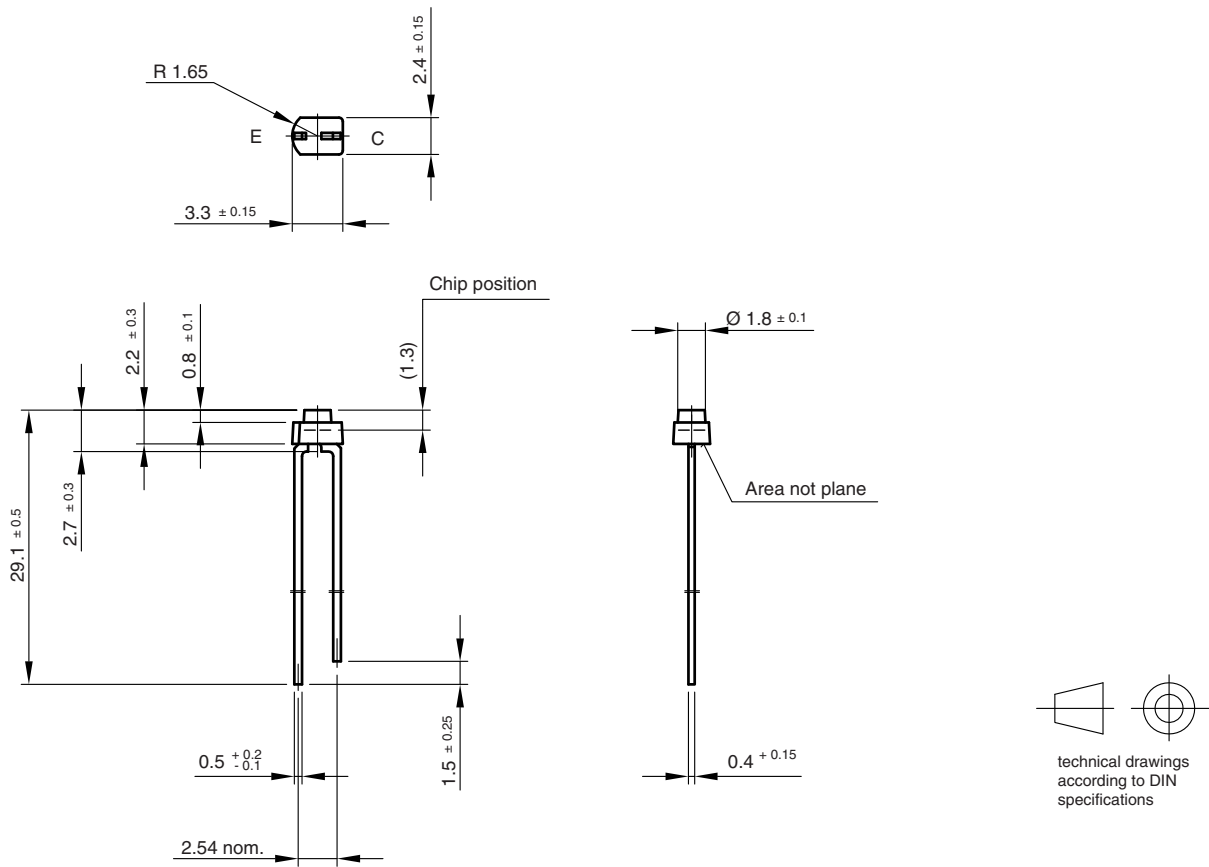
94 8240
Fig. 5 - Collector Emitter Capacitance vs. Collector Emitter Voltage



94 8312
Fig. 8 - Relative Radiant Sensitivity vs. Angular Displacement



PACKAGE DIMENSIONS in millimeters



6.544-5047.01-4
Issue: 2; 19.12.00
96 12188



Disclaimer

ALL PRODUCT, PRODUCT SPECIFICATIONS AND DATA ARE SUBJECT TO CHANGE WITHOUT NOTICE TO IMPROVE RELIABILITY, FUNCTION OR DESIGN OR OTHERWISE.

Vishay Intertechnology, Inc., its affiliates, agents, and employees, and all persons acting on its or their behalf (collectively, "Vishay"), disclaim any and all liability for any errors, inaccuracies or incompleteness contained in any datasheet or in any other disclosure relating to any product.

Vishay makes no warranty, representation or guarantee regarding the suitability of the products for any particular purpose or the continuing production of any product. To the maximum extent permitted by applicable law, Vishay disclaims (i) any and all liability arising out of the application or use of any product, (ii) any and all liability, including without limitation special, consequential or incidental damages, and (iii) any and all implied warranties, including warranties of fitness for particular purpose, non-infringement and merchantability.

Statements regarding the suitability of products for certain types of applications are based on Vishay's knowledge of typical requirements that are often placed on Vishay products in generic applications. Such statements are not binding statements about the suitability of products for a particular application. It is the customer's responsibility to validate that a particular product with the properties described in the product specification is suitable for use in a particular application. Parameters provided in datasheets and / or specifications may vary in different applications and performance may vary over time. All operating parameters, including typical parameters, must be validated for each customer application by the customer's technical experts. Product specifications do not expand or otherwise modify Vishay's terms and conditions of purchase, including but not limited to the warranty expressed therein.

Except as expressly indicated in writing, Vishay products are not designed for use in medical, life-saving, or life-sustaining applications or for any other application in which the failure of the Vishay product could result in personal injury or death. Customers using or selling Vishay products not expressly indicated for use in such applications do so at their own risk. Please contact authorized Vishay personnel to obtain written terms and conditions regarding products designed for such applications.

No license, express or implied, by estoppel or otherwise, to any intellectual property rights is granted by this document or by any conduct of Vishay. Product names and markings noted herein may be trademarks of their respective owners.