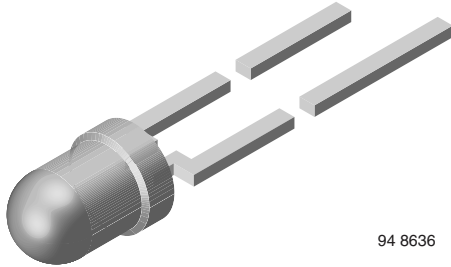




High Power Infrared Emitting Diode, 940 nm, GaAlAs, MQW



FEATURES

- Package type: leaded
- Package form: T-1
- Dimensions (in mm): $\varnothing 3$
- Peak wavelength: $\lambda_p = 940$ nm
- High reliability
- High radiant power
- High radiant intensity
- Angle of half intensity: $\phi = \pm 25^\circ$
- Low forward voltage
- Suitable for high pulse current operation
- Good spectral matching with Si photodetectors
- Package matches with detector TEFT4300
- Material categorization: for definitions of compliance please see www.vishay.com/doc?99912



DESCRIPTION

TSAL4400 is an infrared, 940 nm emitting diode in GaAlAs, MQW technology with high radiant power molded in a blue-gray plastic package.

APPLICATIONS

- Infrared remote control units
- Free air transmission systems
- Infrared source for optical counters and card readers

PRODUCT SUMMARY				
COMPONENT	I_e (mW/sr)	ϕ (deg)	λ_p (nm)	t_r (ns)
TSAL4400	36	± 25	940	15

Note

- Test conditions see table "Basic Characteristics"

ORDERING INFORMATION			
ORDERING CODE	PACKAGING	REMARKS	PACKAGE FORM
TSAL4400	Bulk	MOQ: 5000 pcs, 5000 pcs/bulk	T-1
TSAL4400-RSZ	Ammopack	MOQ: 8000 pcs, 2000 pcs/box	T-1

Note

- MOQ: minimum order quantity

ABSOLUTE MAXIMUM RATINGS ($T_{amb} = 25^\circ\text{C}$, unless otherwise specified)				
PARAMETER	TEST CONDITION	SYMBOL	VALUE	UNIT
Reverse voltage		V_R	5	V
Forward current		I_F	100	mA
Peak forward current	$t_p/T = 0.5, t_p = 100 \mu\text{s}$	I_{FM}	200	mA
Surge forward current	$t_p = 100 \mu\text{s}$	I_{FSM}	1.5	A
Power dissipation		P_V	160	mW
Junction temperature		T_j	100	$^\circ\text{C}$
Operating temperature range		T_{amb}	-40 to +85	$^\circ\text{C}$
Storage temperature range		T_{stg}	-40 to +100	$^\circ\text{C}$
Soldering temperature	$t \leq 5$ s, 2 mm from case	T_{sd}	260	$^\circ\text{C}$
Thermal resistance junction / ambient	J-STD-051, leads 7 mm, soldered on PCB	R_{thJA}	300	K/W

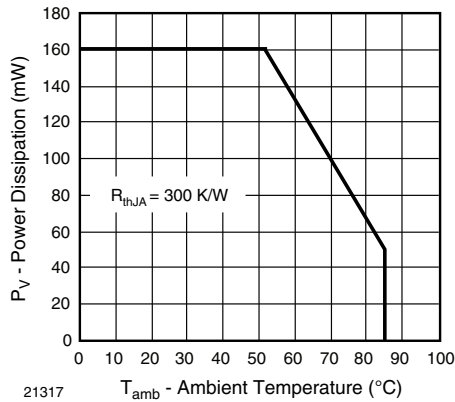


Fig. 1 - Power Dissipation Limit vs. Ambient Temperature

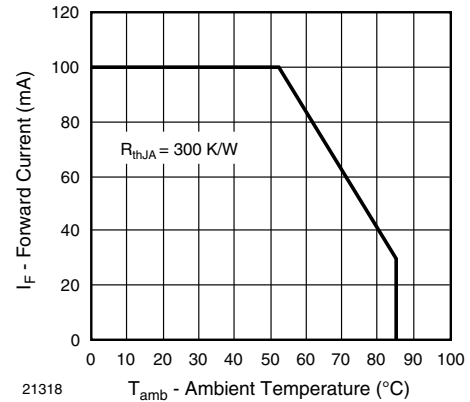


Fig. 2 - Forward Current Limit vs. Ambient Temperature

BASIC CHARACTERISTICS ($T_{amb} = 25\text{ }^{\circ}\text{C}$, unless otherwise specified)						
PARAMETER	TEST CONDITION	SYMBOL	MIN.	TYP.	MAX.	UNIT
Forward voltage	$I_F = 100\text{ mA}$, $t_p = 20\text{ ms}$	V_F	-	1.35	1.6	V
	$I_F = 1\text{ A}$, $t_p = 100\text{ }\mu\text{s}$	V_F	-	2.6	3	V
Temperature coefficient of V_F	$I_F = 1\text{ mA}$	TK_{V_F}	-	-1.8	-	mV/K
Reverse current	$V_R = 5\text{ V}$	I_R	-	-	10	μA
Junction capacitance	$V_R = 0\text{ V}$, $f = 1\text{ MHz}$, $E = 0$	C_j	-	60	-	pF
Radiant intensity	$I_F = 100\text{ mA}$, $t_p = 20\text{ ms}$	I_e	16	36	80	mW/sr
	$I_F = 1\text{ A}$, $t_p = 100\text{ }\mu\text{s}$	I_e	135	290	-	mW/sr
Radiant power	$I_F = 100\text{ mA}$, $t_p = 20\text{ ms}$	ϕ_e	-	40	-	mW
Temperature coefficient of ϕ_e	$I_F = 20\text{ mA}$	TK_{ϕ_e}	-	-0.6	-	%/K
Angle of half intensity		φ	-	± 25	-	deg
Peak wavelength	$I_F = 100\text{ mA}$	λ_p	-	940	-	nm
Spectral bandwidth	$I_F = 100\text{ mA}$	$\Delta\lambda$	-	25	-	nm
Temperature coefficient of λ_p	$I_F = 100\text{ mA}$	TK_{λ_p}	-	0.25	-	nm/K
Rise time	$I_F = 100\text{ mA}$	t_r	-	15	-	ns
Fall time	$I_F = 100\text{ mA}$	t_f	-	15	-	ns

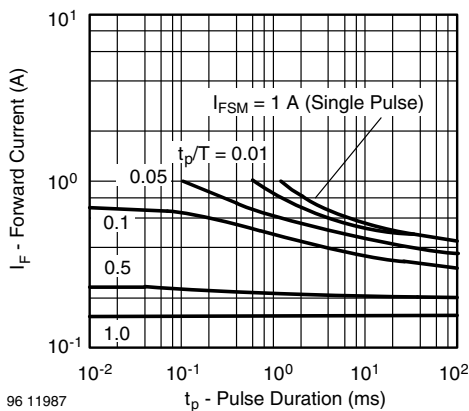
BASIC CHARACTERISTICS ($T_{amb} = 25\text{ }^{\circ}\text{C}$, unless otherwise specified)


Fig. 3 - Pulse Forward Current vs. Pulse Duration

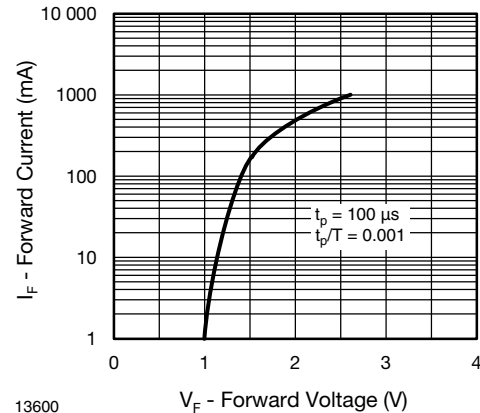


Fig. 4 - Forward Current vs. Forward Voltage

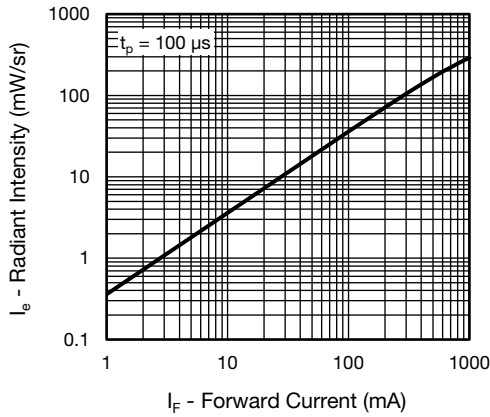


Fig. 5 - Radiant Intensity vs. Forward Current

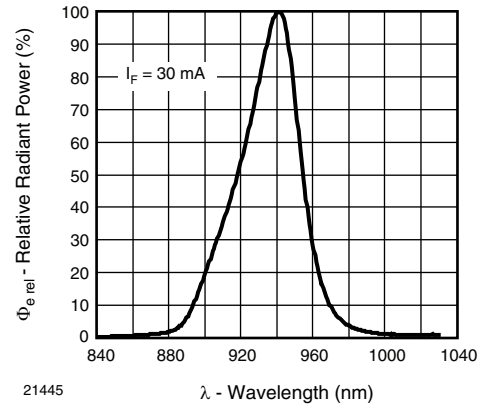


Fig. 8 - Relative Radiant Power vs. Wavelength

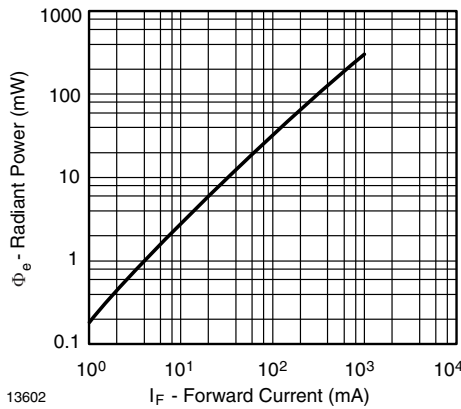


Fig. 6 - Radiant Power vs. Forward Current

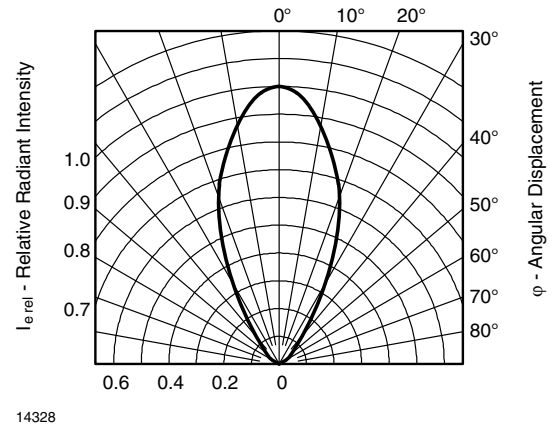


Fig. 9 - Relative Radiant Intensity vs. Angular Displacement

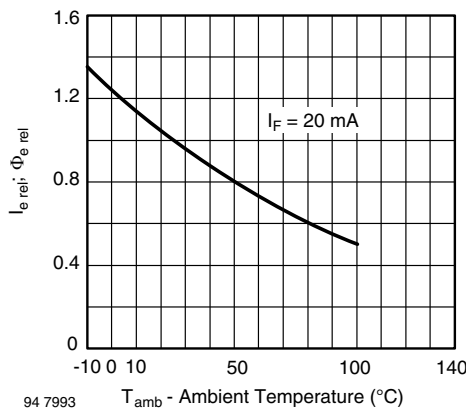
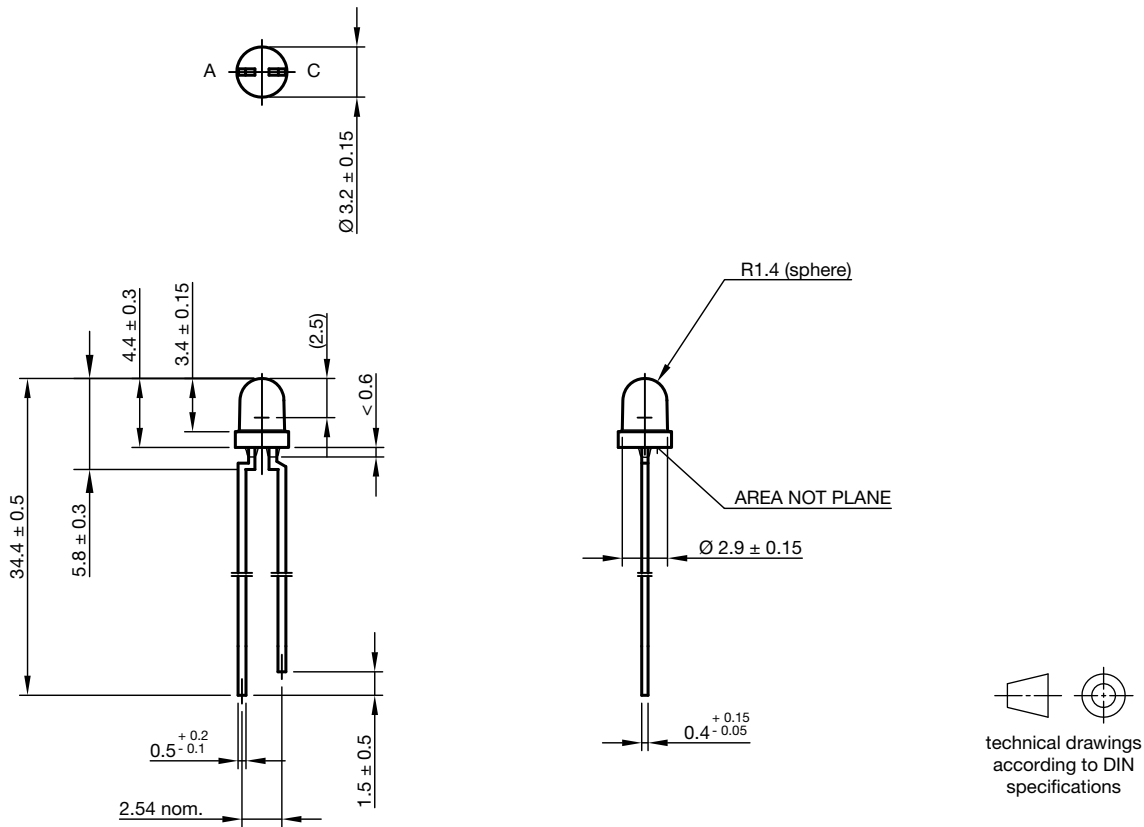


Fig. 7 - Rel. Radiant Intensity/Power vs. Ambient Temperature



PACKAGE DIMENSIONS in millimeters



technical drawings according to DIN specifications

Drawing-No.: 6.544-5255.01-4
Issue: 9; 28.07.14



Disclaimer

ALL PRODUCT, PRODUCT SPECIFICATIONS AND DATA ARE SUBJECT TO CHANGE WITHOUT NOTICE TO IMPROVE RELIABILITY, FUNCTION OR DESIGN OR OTHERWISE.

Vishay Intertechnology, Inc., its affiliates, agents, and employees, and all persons acting on its or their behalf (collectively, "Vishay"), disclaim any and all liability for any errors, inaccuracies or incompleteness contained in any datasheet or in any other disclosure relating to any product.

Vishay makes no warranty, representation or guarantee regarding the suitability of the products for any particular purpose or the continuing production of any product. To the maximum extent permitted by applicable law, Vishay disclaims (i) any and all liability arising out of the application or use of any product, (ii) any and all liability, including without limitation special, consequential or incidental damages, and (iii) any and all implied warranties, including warranties of fitness for particular purpose, non-infringement and merchantability.

Statements regarding the suitability of products for certain types of applications are based on Vishay's knowledge of typical requirements that are often placed on Vishay products in generic applications. Such statements are not binding statements about the suitability of products for a particular application. It is the customer's responsibility to validate that a particular product with the properties described in the product specification is suitable for use in a particular application. Parameters provided in datasheets and / or specifications may vary in different applications and performance may vary over time. All operating parameters, including typical parameters, must be validated for each customer application by the customer's technical experts. Product specifications do not expand or otherwise modify Vishay's terms and conditions of purchase, including but not limited to the warranty expressed therein.

Hyperlinks included in this datasheet may direct users to third-party websites. These links are provided as a convenience and for informational purposes only. Inclusion of these hyperlinks does not constitute an endorsement or an approval by Vishay of any of the products, services or opinions of the corporation, organization or individual associated with the third-party website. Vishay disclaims any and all liability and bears no responsibility for the accuracy, legality or content of the third-party website or for that of subsequent links.

Except as expressly indicated in writing, Vishay products are not designed for use in medical, life-saving, or life-sustaining applications or for any other application in which the failure of the Vishay product could result in personal injury or death. Customers using or selling Vishay products not expressly indicated for use in such applications do so at their own risk. Please contact authorized Vishay personnel to obtain written terms and conditions regarding products designed for such applications.

No license, express or implied, by estoppel or otherwise, to any intellectual property rights is granted by this document or by any conduct of Vishay. Product names and markings noted herein may be trademarks of their respective owners.