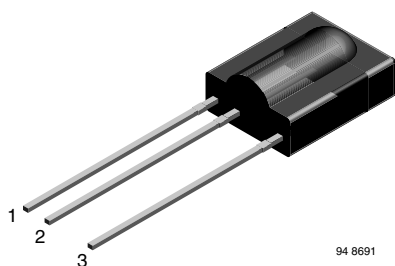




IR Receiver Modules for Remote Control Systems



94 8691

MECHANICAL DATA

Pinning:

1 = GND, 2 = V_S , 3 = OUT

FEATURES

- Very low supply current
- Photo detector and preamplifier in one package
- Internal filter for PCM frequency
- Improved shielding against EMI
- Supply voltage: 2.5 V to 5.5 V
- Improved immunity against ambient light
- Insensitive to supply voltage ripple and noise
- Compliant to RoHS Directive 2011/65/EU and in accordance to WEEE 2002/96/EC



Note

** Please see document "Vishay Material Category Policy": www.vishay.com/doc?99902

DESCRIPTION

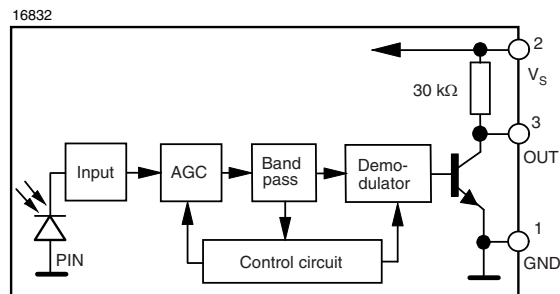
The TSOP1#.. series are miniaturized receivers for infrared remote control systems. A PIN diode and a preamplifier are assembled on a lead frame, the epoxy package acts as an IR filter.

The demodulated output signal can be directly decoded by a microprocessor. The TSOP11.. is compatible with all common IR remote control data formats. The TSOP13.. is optimized to better suppress spurious pulses from energy saving fluorescent lamps but will also suppress some data signals.

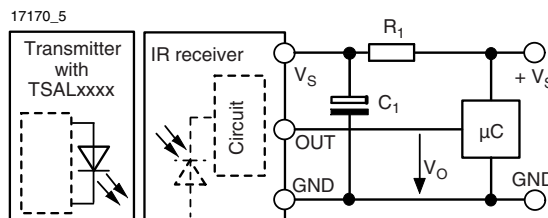
This component has not been qualified according to automotive specifications.

PARTS TABLE		
CARRIER FREQUENCY	SHORT BURST AND HIGH DATA RATES (AGC1)	NOISY ENVIRONMENTS AND SHORT BURTS (AGC3)
30 kHz	TSOP1130	TSOP1330
33 kHz	TSOP1133	TSOP1333
36 kHz	TSOP1136	TSOP1336
36.7 kHz	TSOP1137	TSOP1337
38 kHz	TSOP1138	TSOP1338
40 kHz	TSOP1140	TSOP1340
56 kHz	TSOP1156	TSOP1356

BLOCK DIAGRAM



APPLICATION CIRCUIT



R_1 and C_1 are recommended for protection against EOS. Components should be in the range of $33 \Omega < R_1 < 1 \text{ k}\Omega$, $C_1 > 0.1 \mu\text{F}$.

ABSOLUTE MAXIMUM RATINGS				
PARAMETER	TEST CONDITION	SYMBOL	VALUE	UNIT
Supply voltage (pin 2)		V_S	- 0.3 to + 6	V
Supply current (pin 2)		I_S	3	mA
Output voltage (pin 3)		V_O	- 0.3 to ($V_S + 0.3$)	V
Output current (pin 3)		I_O	5	mA
Junction temperature		T_j	100	°C
Storage temperature range		T_{stg}	- 25 to + 85	°C
Operating temperature range		T_{amb}	- 25 to + 85	°C
Power consumption	$T_{amb} \leq 85$ °C	P_{tot}	10	mW
Soldering temperature	$t \leq 10$ s, 1 mm from case	T_{sd}	260	°C

Note

- Stresses beyond those listed under “Absolute Maximum Ratings” may cause permanent damage to the device. This is a stress rating only and functional operation of the device at these or any other conditions beyond those indicated in the operational sections of this specification is not implied. Exposure to absolute maximum rating conditions for extended periods may affect the device reliability.

ELECTRICAL AND OPTICAL CHARACTERISTICS ($T_{amb} = 25$ °C, unless otherwise specified)						
PARAMETER	TEST CONDITION	SYMBOL	MIN.	TYP.	MAX.	UNIT
Supply voltage		V_S	2.5		5.5	V
Supply current (pin 2)	$E_v = 0, V_S = 3.3$ V	I_{SD}	0.27	0.35	0.45	mA
	$E_v = 40$ klx, sunlight	I_{SH}		0.45		mA
Transmission distance	$E_v = 0$, test signal see fig. 1, IR diode TSAL6200, $I_F = 250$ mA	d		45		m
Output voltage low (pin 3)	$I_{OSL} = 0.5$ mA, $E_e = 0.7$ mW/m ² , test signal see fig. 1	V_{OSL}			100	mV
Minimum irradiance	Pulse width tolerance: $t_{pi} - 5/f_0 < t_{po} < t_{pi} + 6/f_0$, test signal see fig. 1	E_e min.		0.15	0.35	mW/m ²
Maximum irradiance	$t_{pi} - 5/f_0 < t_{po} < t_{pi} + 6/f_0$, test signal see fig. 1	E_e max.	30			W/m ²
Directivity	Angle of half transmission distance	$\phi_{1/2}$		± 45		deg

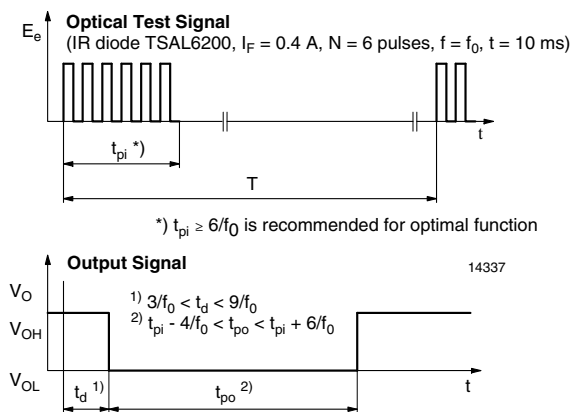
TYPICAL CHARACTERISTICS ($T_{amb} = 25$ °C, unless otherwise specified)


Fig. 1 - Output Active Low

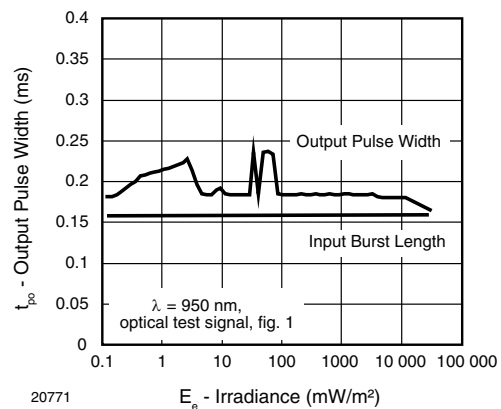


Fig. 2 - Pulse Length and Sensitivity in Dark Ambient

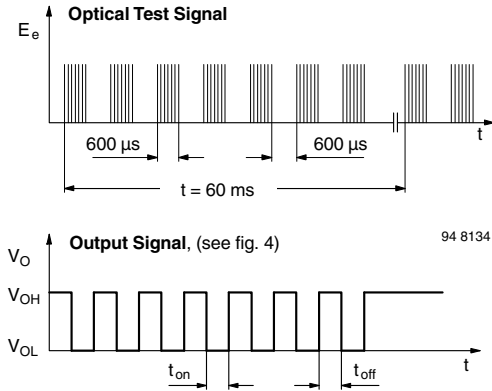


Fig. 3 - Output Function

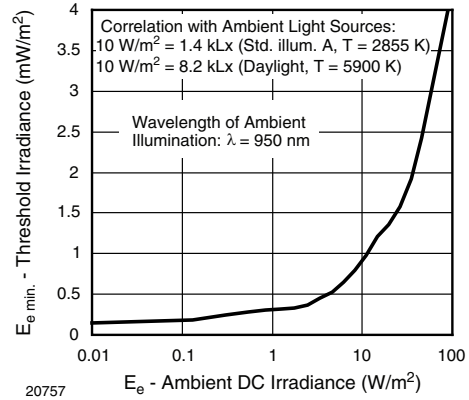


Fig. 6 - Sensitivity in Bright Ambient

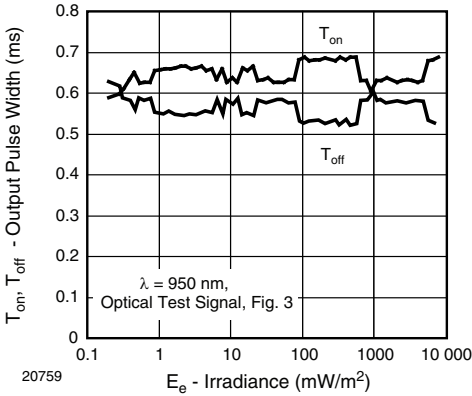


Fig. 4 - Output Pulse Diagram

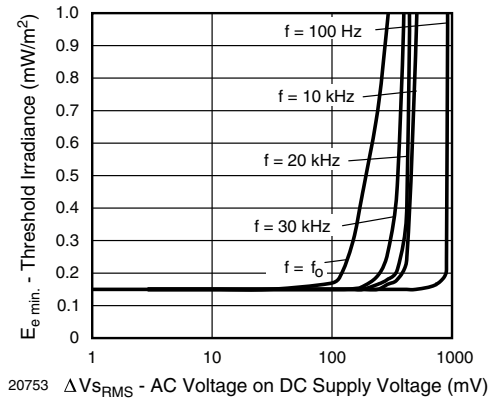


Fig. 7 - Sensitivity vs. Supply Voltage Disturbances

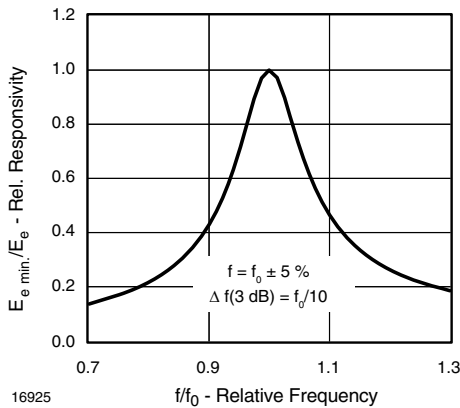


Fig. 5 - Frequency Dependence of Responsivity

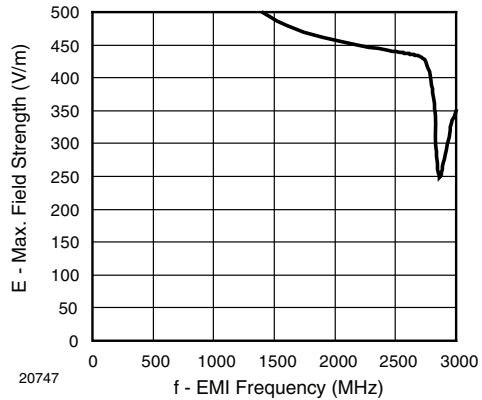


Fig. 8 - Sensitivity vs. Electric Field Disturbances

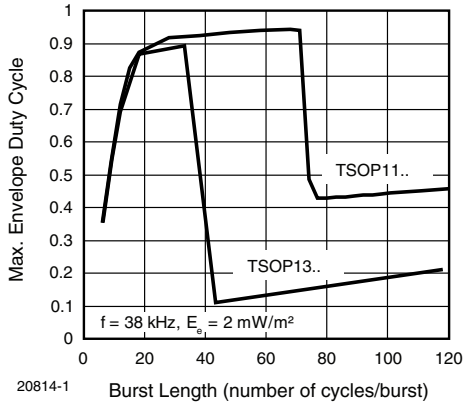


Fig. 9 - Max. Envelope Duty Cycle vs. Burst Length

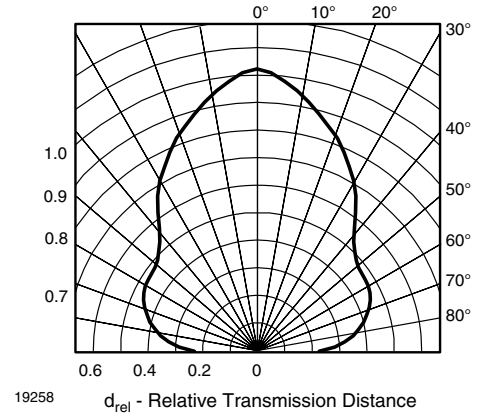


Fig. 12 - Horizontal Directivity

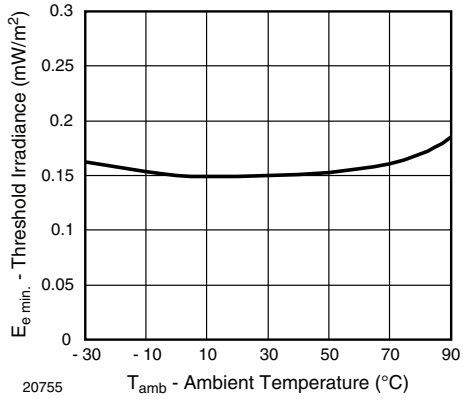


Fig. 10 - Sensitivity vs. Ambient Temperature

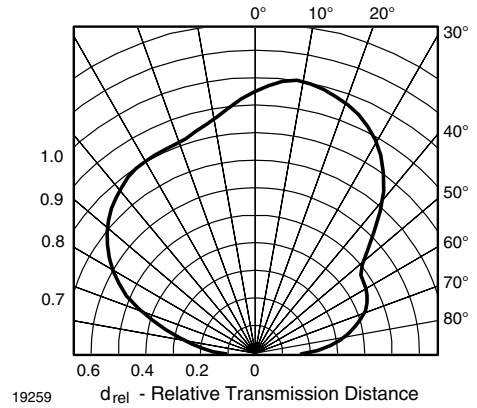


Fig. 13 - Vertical Directivity

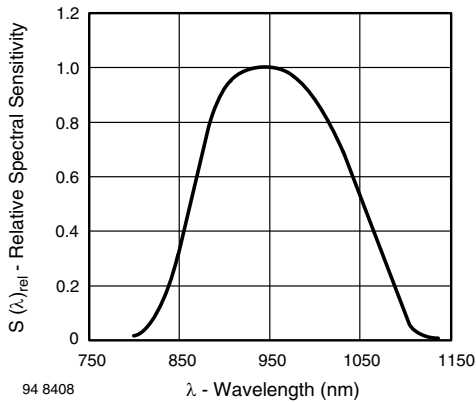


Fig. 11 - Relative Spectral Sensitivity vs. Wavelength

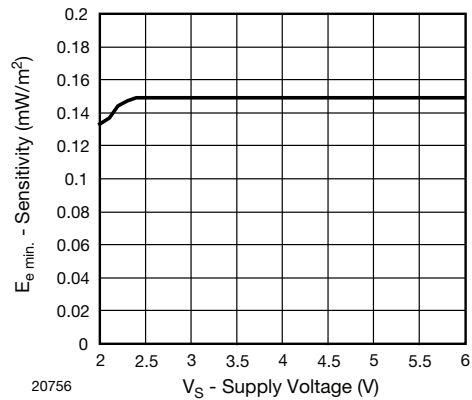


Fig. 14 - Sensitivity vs. Supply Voltage



SUITABLE DATA FORMAT

The TSOP11.., TSOP13.. series is designed to suppress spurious output pulses due to noise or disturbance signals. Data and disturbance signals can be distinguished by the devices according to carrier frequency, burst length and envelope duty cycle. The data signal should be close to the band-pass center frequency (e.g. 38 kHz) and fulfill the conditions in the table below.

When a data signal is applied to the TSOP1#.. in the presence of a disturbance signal, the sensitivity of the receiver is reduced to insure that no spurious pulses are present at the output. Some examples of disturbance signals which are suppressed are:

- DC light (e.g. from tungsten bulb or sunlight)
- Continuous signals at any frequency
- Modulated noise from fluorescent lamps with electronic ballasts

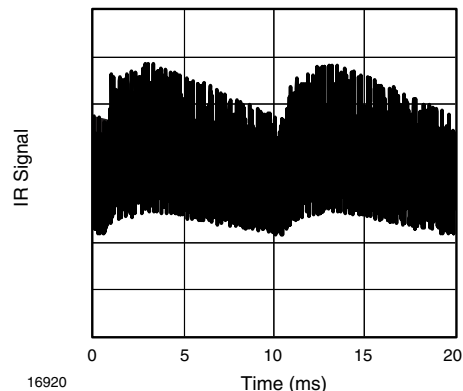


Fig. 15 - IR Signal from Fluorescent Lamp with Low Modulation

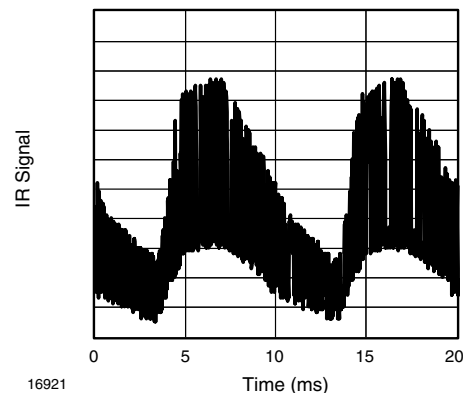


Fig. 16 - IR Signal from Fluorescent Lamp with High Modulation

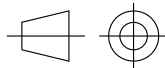
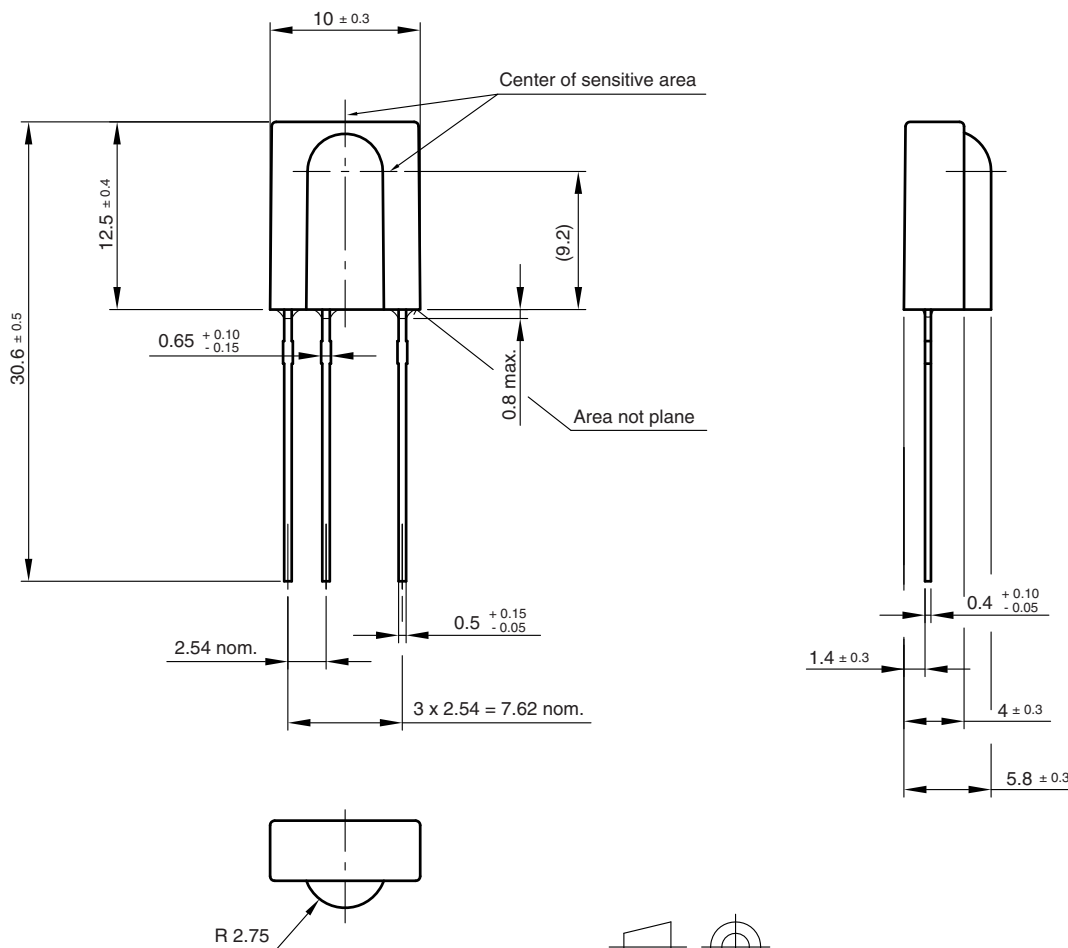
	TSOP11..	TSOP13..
Minimum burst length	6 cycles/burst	6 cycles/burst
After each burst of length a minimum gap time is required of	6 to 70 cycles ≥ 10 cycles	6 to 35 cycles ≥ 10 cycles
For bursts greater than a minimum gap time in the data stream is needed of	70 cycles > 1.2 x burst length	35 cycles > 6 x burst length
Maximum number of continuous short bursts/second	2000	2000
Recommended for NEC code	yes	yes
Recommended for RC5/RC6 code	yes	yes
Recommended for Sony code	yes	no
Recommended for RCMM code	yes	yes
Recommended for r-step code	yes	yes
Recommended for XMP code	yes	yes
Suppression of interference from fluorescent lamps	Common disturbance signals are suppressed (example: signal pattern of fig. 15)	Even critical disturbance signals are suppressed (examples: signal pattern of fig. 15 and fig. 16)

Note

- For data formats with long bursts (more than 10 carrier cycles) please see the datasheet for TSOP12.



PACKAGE DIMENSIONS in millimeters



technical drawings according to DIN specifications

Drawing-No.: 6.550-5095.01-4

Issue: 20; 15.03.10

96 12116



Disclaimer

ALL PRODUCT, PRODUCT SPECIFICATIONS AND DATA ARE SUBJECT TO CHANGE WITHOUT NOTICE TO IMPROVE RELIABILITY, FUNCTION OR DESIGN OR OTHERWISE.

Vishay Intertechnology, Inc., its affiliates, agents, and employees, and all persons acting on its or their behalf (collectively, "Vishay"), disclaim any and all liability for any errors, inaccuracies or incompleteness contained in any datasheet or in any other disclosure relating to any product.

Vishay makes no warranty, representation or guarantee regarding the suitability of the products for any particular purpose or the continuing production of any product. To the maximum extent permitted by applicable law, Vishay disclaims (i) any and all liability arising out of the application or use of any product, (ii) any and all liability, including without limitation special, consequential or incidental damages, and (iii) any and all implied warranties, including warranties of fitness for particular purpose, non-infringement and merchantability.

Statements regarding the suitability of products for certain types of applications are based on Vishay's knowledge of typical requirements that are often placed on Vishay products in generic applications. Such statements are not binding statements about the suitability of products for a particular application. It is the customer's responsibility to validate that a particular product with the properties described in the product specification is suitable for use in a particular application. Parameters provided in datasheets and/or specifications may vary in different applications and performance may vary over time. All operating parameters, including typical parameters, must be validated for each customer application by the customer's technical experts. Product specifications do not expand or otherwise modify Vishay's terms and conditions of purchase, including but not limited to the warranty expressed therein.

Except as expressly indicated in writing, Vishay products are not designed for use in medical, life-saving, or life-sustaining applications or for any other application in which the failure of the Vishay product could result in personal injury or death. Customers using or selling Vishay products not expressly indicated for use in such applications do so at their own risk. Please contact authorized Vishay personnel to obtain written terms and conditions regarding products designed for such applications.

No license, express or implied, by estoppel or otherwise, to any intellectual property rights is granted by this document or by any conduct of Vishay. Product names and markings noted herein may be trademarks of their respective owners.

Material Category Policy

Vishay Intertechnology, Inc. hereby certifies that all its products that are identified as RoHS-Compliant fulfill the definitions and restrictions defined under Directive 2011/65/EU of The European Parliament and of the Council of June 8, 2011 on the restriction of the use of certain hazardous substances in electrical and electronic equipment (EEE) - recast, unless otherwise specified as non-compliant.

Please note that some Vishay documentation may still make reference to RoHS Directive 2002/95/EC. We confirm that all the products identified as being compliant to Directive 2002/95/EC conform to Directive 2011/65/EU.

Vishay Intertechnology, Inc. hereby certifies that all its products that are identified as Halogen-Free follow Halogen-Free requirements as per JEDEC JS709A standards. Please note that some Vishay documentation may still make reference to the IEC 61249-2-21 definition. We confirm that all the products identified as being compliant to IEC 61249-2-21 conform to JEDEC JS709A standards.