

Power Mini SMD LED

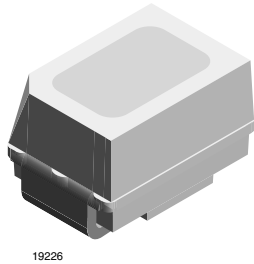

FEATURES

- SMD LEDs with exceptional brightness
- Luminous intensity categorized
- Compatible with automatic placement equipment
- IR reflow soldering
- Available in 8 mm tape
- Low profile package
- Non-diffused lens: excellent for coupling to light pipes and backlighting
- Low power consumption
- Luminous intensity ratio in one packing unit
 $I_{Vmax}/I_{Vmin} \leq 2.0$, optional ≤ 1.6
- Lead (Pb)-free device



DESCRIPTION

The new MiniLED Series have been designed in a small white SMT package. The feature of the device is the very small package 2.3 mm x 1.3 mm x 1.4 mm. The MiniLED is an obvious solution for small-scale, high-power products that are expected to work reliability in an arduous environment. This is often the case in automotive and industrial application.

PRODUCT GROUP AND PACKAGE DATA

- Product group: LED
- Package: SMD MiniLED
- Product series: power
- Angle of half intensity: $\pm 60^\circ$

APPLICATIONS

- Automotive: backlighting in dashboards and switches
- Telecommunication: indicator and backlighting in telephone and fax
- Indicator and backlight for audio and video equipment
- Indicator and backlight in office equipment
- Flat backlight for LCDs, switches and symbols

PARTS TABLE		
PART	COLOR, LUMINOUS INTENSITY	TECHNOLOGY
TLMK2300	Red, $I_V = 80$ mcd (typ.)	AllnGaP on GaAs
TLMF2300	Orange, $I_V = 120$ mcd (typ.)	AllnGaP on GaAs
TLME2300	Yellow, $I_V = 120$ mcd (typ.)	AllnGaP on GaAs



ABSOLUTE MAXIMUM RATINGS¹⁾ TLMK230., TLMF230., TLME230.				
PARAMETER	TEST CONDITION	SYMBOL	VALUE	UNIT
Reverse voltage ²⁾		V_R	5	V
DC Forward current	$T_{amb} \leq 80 \text{ }^\circ\text{C}$	I_F	30	mA
Surge forward current	$t_p \leq 10 \text{ } \mu\text{s}$	I_{FSM}	0.1	A
Power dissipation	$T_{amb} \leq 80 \text{ }^\circ\text{C}$	P_V	80	mW
Junction temperature		T_j	125	$^\circ\text{C}$
Operating temperature range		T_{amb}	- 40 to + 100	$^\circ\text{C}$
Storage temperature range		T_{stg}	- 40 to + 100	$^\circ\text{C}$
Soldering temperature	according to IPC 9501	T_{sd}	245	$^\circ\text{C}$
Thermal resistance junction/ ambient	mounted on PC board (pad size > 5 mm ²)	R_{thJA}	580	K/W

Note:

- 1) $T_{amb} = 25 \text{ }^\circ\text{C}$, unless otherwise specified
- 2) Driving the LED in reverse direction is suitable for a short term application

OPTICAL AND ELECTRICAL CHARACTERISTICS¹⁾ TLMK230., RED						
PARAMETER	TEST CONDITION	SYMBOL	MIN	TYP.	MAX	UNIT
Luminous intensity ²⁾	$I_F = 20 \text{ mA}$	I_V	32	80		mcd
Dominant wavelength	$I_F = 20 \text{ mA}$	λ_d		630		nm
Peak wavelength	$I_F = 20 \text{ mA}$	λ_p		643		nm
Angle of half intensity	$I_F = 20 \text{ mA}$	φ		± 60		deg
Forward voltage	$I_F = 20 \text{ mA}$	V_F		1.9	2.6	V
Reverse voltage	$I_R = 10 \text{ } \mu\text{A}$	V_R	5			V
Junction capacitance	$V_R = 0, f = 1 \text{ MHz}$	C_j		15		pF

Note:

- 1) $T_{amb} = 25 \text{ }^\circ\text{C}$, unless otherwise specified
- 2) in one packing unit $I_{Vmax}/I_{Vmin} \leq 2.0$

OPTICAL AND ELECTRICAL CHARACTERISTICS¹⁾ TLMF230., ORANGE						
PARAMETER	TEST CONDITION	SYMBOL	MIN	TYP.	MAX	UNIT
Luminous intensity ²⁾	$I_F = 20 \text{ mA}$	I_V	50	120		mcd
Dominant wavelength	$I_F = 20 \text{ mA}$	λ_d	598	605	611	nm
Peak wavelength	$I_F = 20 \text{ mA}$	λ_p		610		nm
Angle of half intensity	$I_F = 20 \text{ mA}$	φ		± 60		deg
Forward voltage	$I_F = 20 \text{ mA}$	V_F		2.0	2.6	V
Reverse voltage	$I_R = 10 \text{ } \mu\text{A}$	V_R	5			V
Junction capacitance	$V_R = 0, f = 1 \text{ MHz}$	C_j		15		pF

Note:

- 1) $T_{amb} = 25 \text{ }^\circ\text{C}$, unless otherwise specified
- 2) in one packing unit $I_{Vmax}/I_{Vmin} \leq 2.0$

OPTICAL AND ELECTRICAL CHARACTERISTICS¹⁾ TLME230., YELLOW						
PARAMETER	TEST CONDITION	SYMBOL	MIN	TYP.	MAX	UNIT
Luminous intensity ²⁾	$I_F = 20 \text{ mA}$	I_V	50	120		mcd
Dominant wavelength	$I_F = 20 \text{ mA}$	λ_d	581	588	594	nm
Peak wavelength	$I_F = 20 \text{ mA}$	λ_p		590		nm
Angle of half intensity	$I_F = 20 \text{ mA}$	ϕ		± 60		deg
Forward voltage	$I_F = 20 \text{ mA}$	V_F		2.0	2.6	V
Reverse voltage	$I_R = 10 \mu\text{A}$	V_R	5			V
Junction capacitance	$V_R = 0, f = 1 \text{ MHz}$	C_j		15		pF

Note:

1) $T_{amb} = 25 \text{ }^\circ\text{C}$, unless otherwise specified

2) in one packing unit $I_{Vmax}/I_{Vmin} \leq 2.0$

TYPICAL CHARACTERISTICS

$T_{amb} = 25 \text{ }^\circ\text{C}$, unless otherwise specified

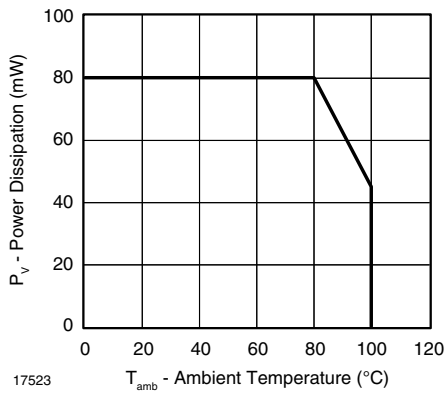

Figure 1. Power Dissipation vs. Ambient Temperature

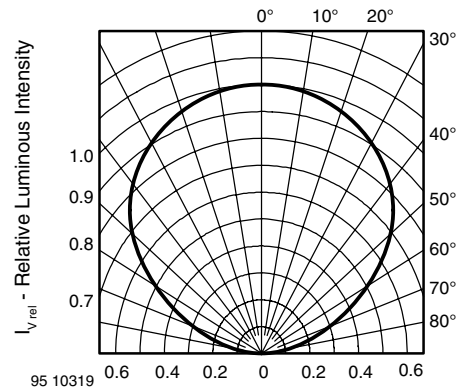

Figure 3. Rel. Luminous Intensity vs. Angular Displacement

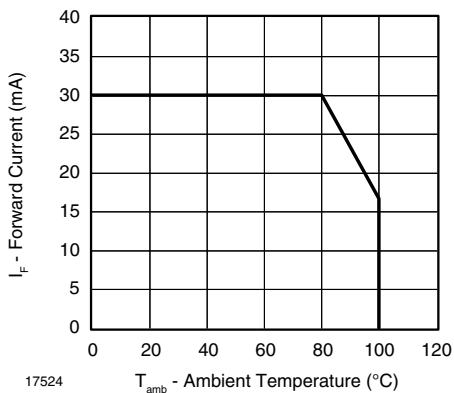

Figure 2. Forward Current vs. Ambient Temperature

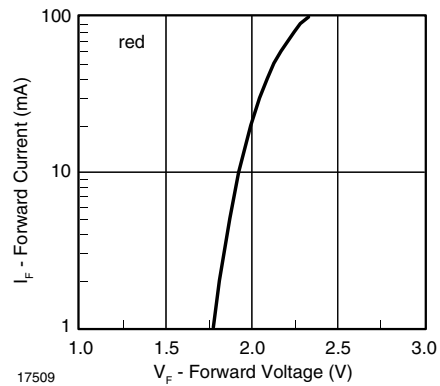

Figure 4. Forward Current vs. Forward Voltage

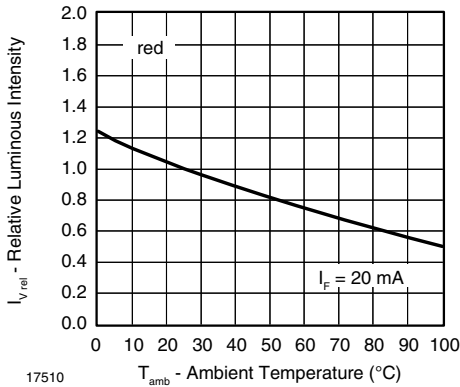

Figure 5. Rel. Luminous Intensity vs. Ambient Temperature

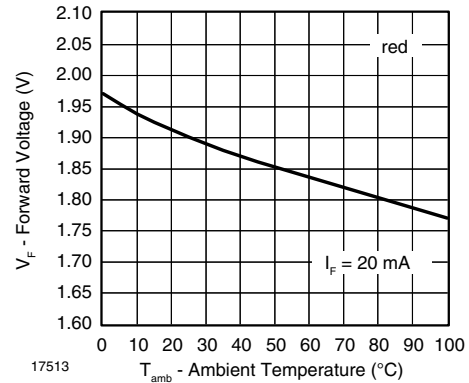

Figure 8. Forward Voltage vs. Ambient Temperature

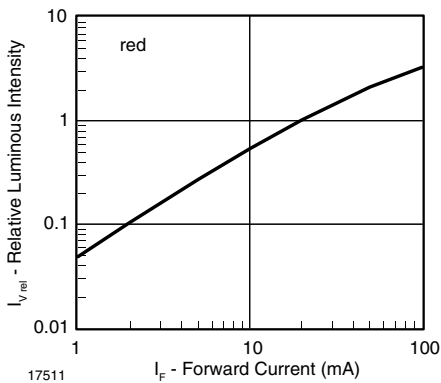

Figure 6. Relative Luminous Intensity vs. Forward Current

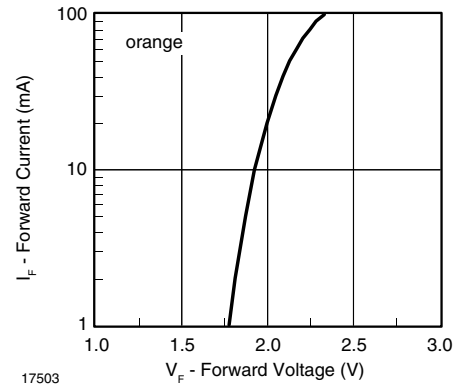

Figure 9. Forward Current vs. Forward Voltage

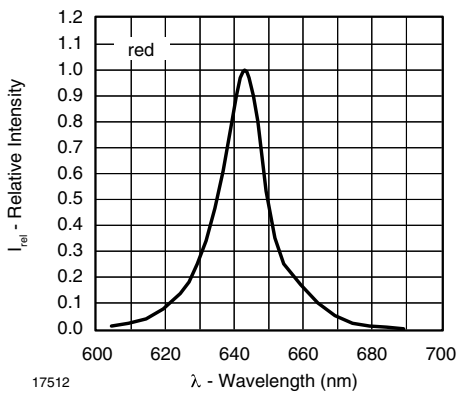

Figure 7. Relative Intensity vs. Wavelength

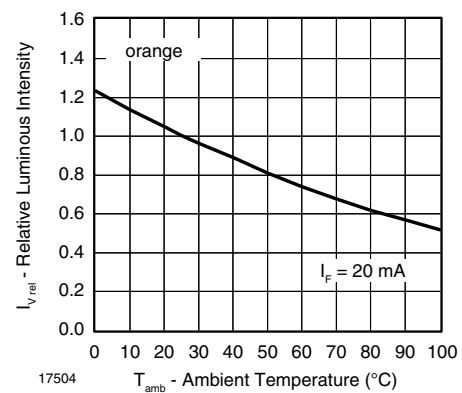

Figure 10. Rel. Luminous Intensity vs. Ambient Temperature

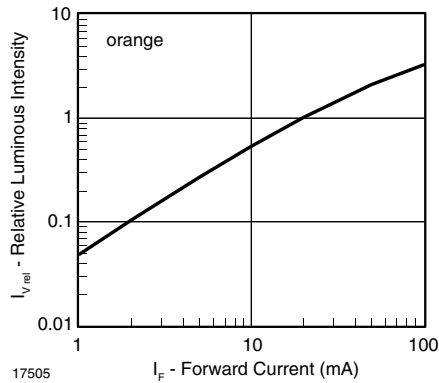

Figure 11. Relative Luminous Intensity vs. Forward Current

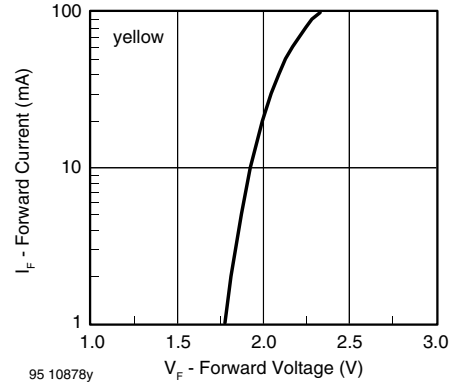

Figure 14. Forward Current vs. Forward Voltage

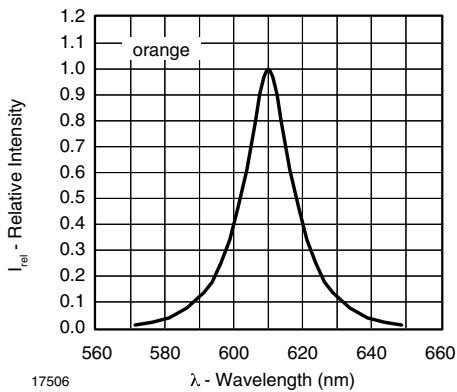

Figure 12. Relative Intensity vs. Wavelength

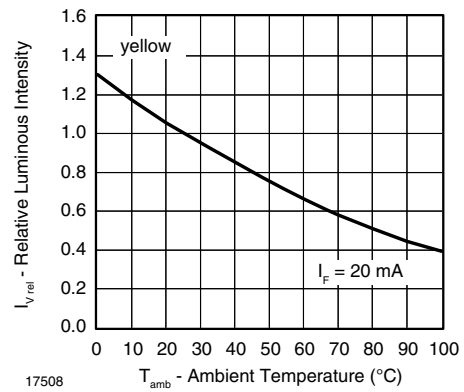

Figure 15. Rel. Luminous Intensity vs. Ambient Temperature

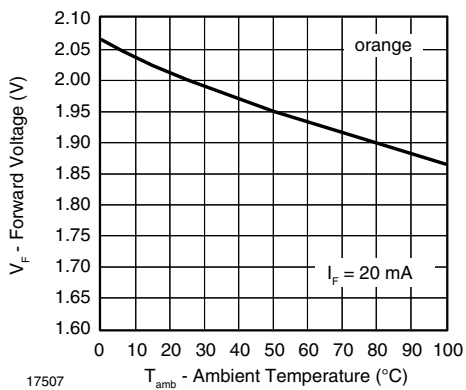

Figure 13. Forward Voltage vs. Ambient Temperature

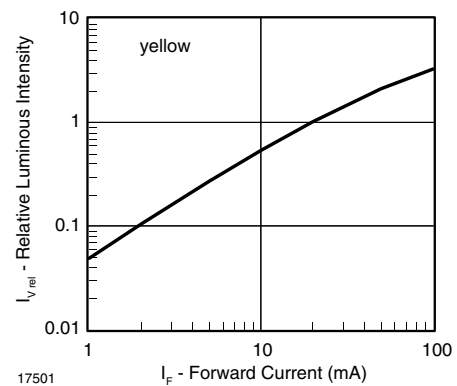

Figure 16. Relative Luminous Intensity vs. Forward Current

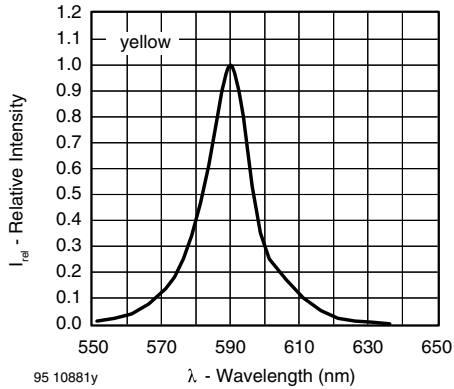

Figure 17. Relative Intensity vs. Wavelength

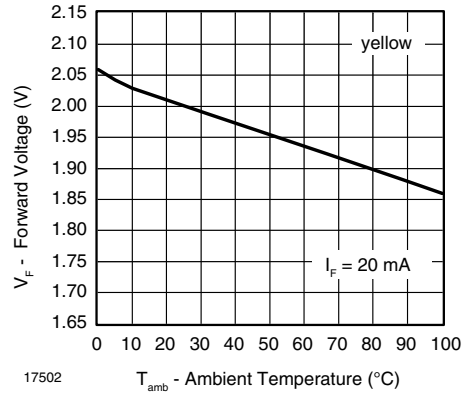
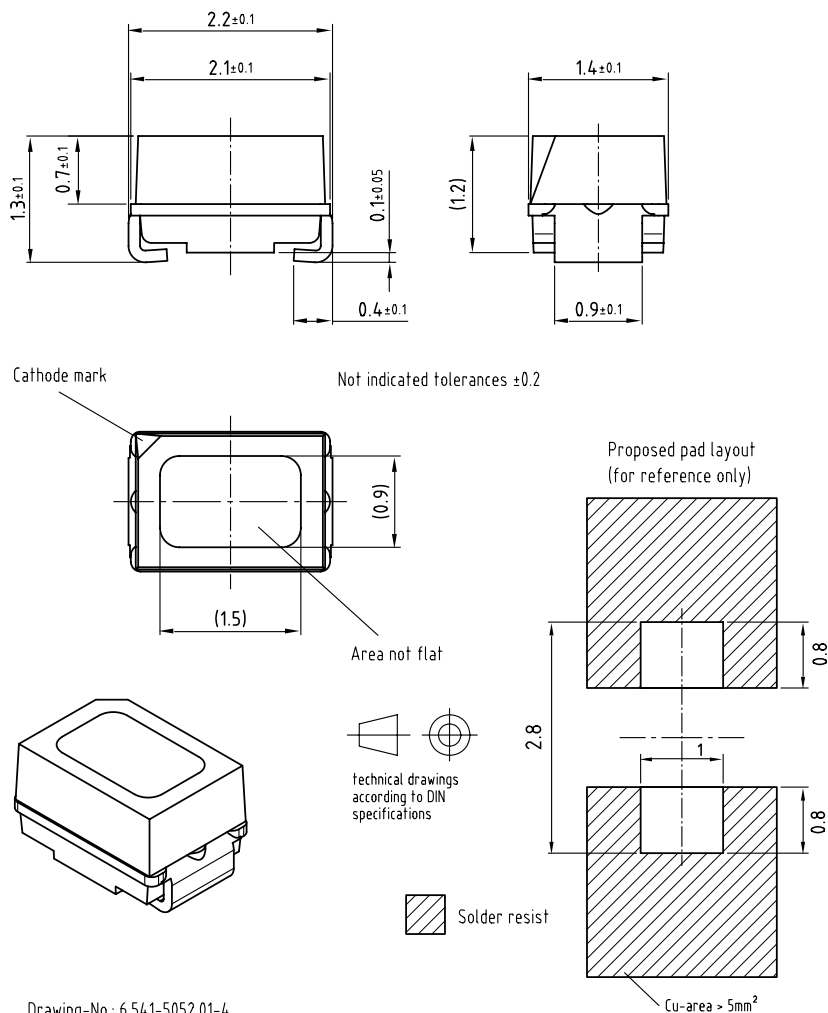

Figure 18. Forward Voltage vs. Ambient Temperature

PACKAGE DIMENSIONS in millimeters



Drawing-No.: 6.541-5052.01-4
 Issue: 3; 22.04.03
 16892



REEL DIMENSIONS in millimeters

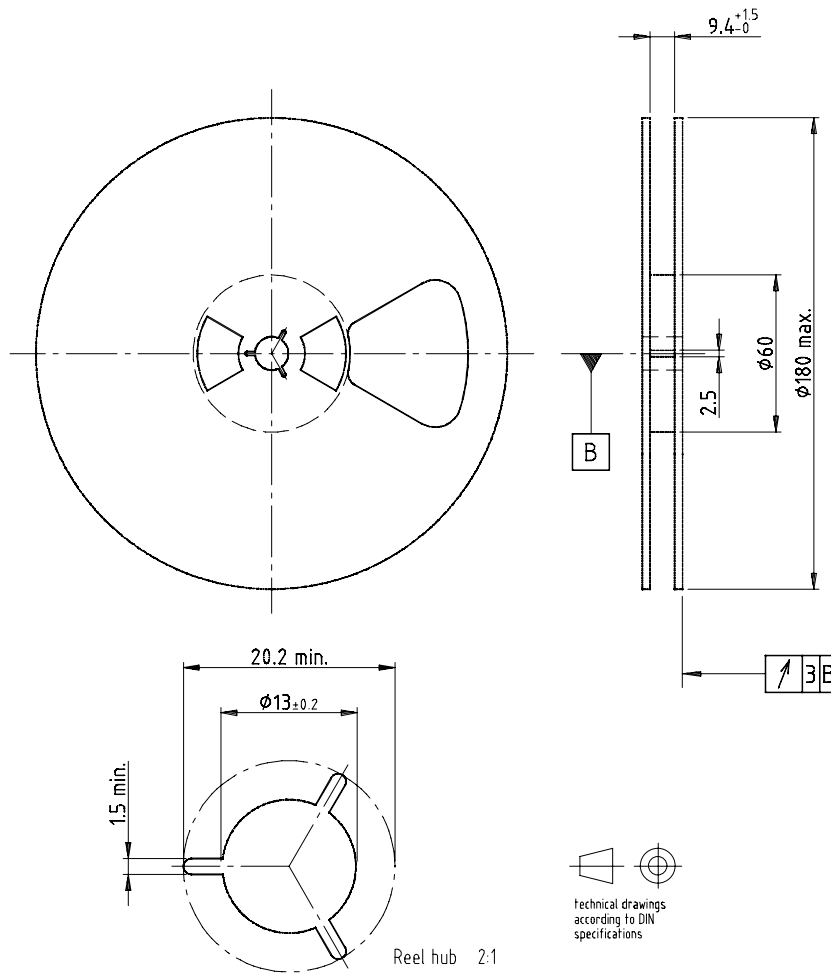

Drawing-No.: 9 800-5051.V5-4

Issue: 1; 25.07.02

16938

TAPE DIMENSIONS in millimeters

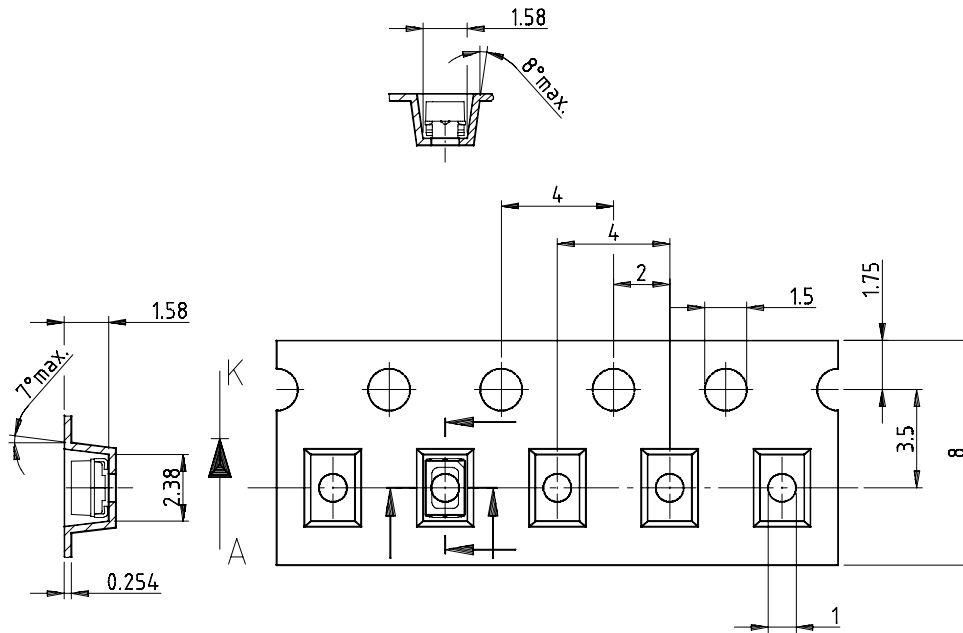

Drawing-No.: 9.700-5266.01-4
Issue: 1; 05.06.02
16939

LEADER AND TRAILER in millimeters

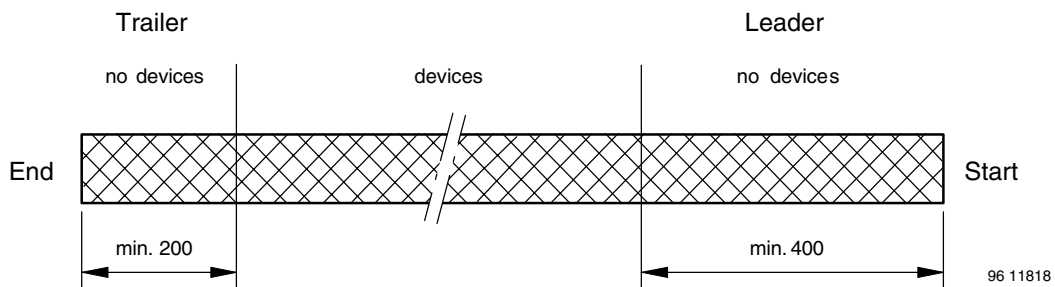

GS08 = 3000 pcs



COVER TAPE PEEL STRENGTH

According to DIN EN 60286-3
0.1 to 1.3 N
300 ± 10 mm/min
165 ° - 180 ° peel angle

LABEL

Standard bar code labels for finished goods

The standard bar code labels are product labels and used for identification of goods. The finished goods are packed in final packing area. The standard packing units are labeled with standard bar code labels before transported as finished goods to warehouses. The labels are on each packing unit and contain Vishay Semiconductor GmbH specific data.

VISHAY SEMICONDUCTOR GMBH STANDARD BAR CODE PRODUCT LABEL (FINISHED GOODS)

PLAIN WRITTING	ABBREVIATION	LENGTH
Item-description	-	18
Item-number	INO	8
Selection-code	SEL	3
LOT-/serial-number	BATCH	10
Data-code	COD	3 (YWW)
Plant-code	PTC	2
Quantity	QTY	8
Accepted by:	ACC	-
Packed by:	PCK	-
Mixed code indicator	MIXED CODE	-
Origin	xxxxxxx ⁺	Company logo
LONG BAR CODE TOP	TYPE	LENGTH
Item-number	N	8
Plant-code	N	2
Sequence-number	X	3
Quantity	N	8
Total length	-	21
SHORT BAR CODE BOTTOM	TYPE	LENGTH
Selection-code	X	3
Data-code	N	3
Batch-number	X	10
Filter	-	1
Total length	-	17

DRY PACKING

The reel is packed in an anti-humidity bag to protect the devices from absorbing moisture during transportation and storage.

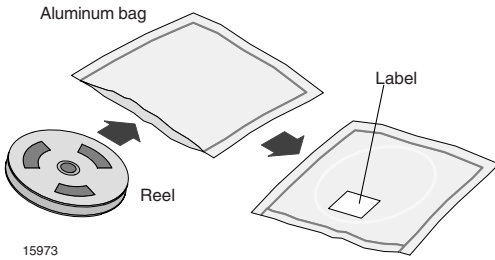

FINAL PACKING

The sealed reel is packed into a cardboard box. A secondary cardboard box is used for shipping purposes.

RECOMMENDED METHOD OF STORAGE

Dry box storage is recommended as soon as the aluminium bag has been opened to prevent moisture absorption. The following conditions should be observed, if dry boxes are not available:

- Storage temperature 10 °C to 30 °C
- Storage humidity ≤ 60 % RH max.

After more than 1 year under these conditions moisture content will be too high for reflow soldering.

In case of moisture absorption, the devices will recover to the former condition by drying under the following condition:

192 h at 40 °C + 5 °C/-0 °C and < 5 % RH (dry air/nitrogen) or

96 h at 60 °C +5 °C and < 5 % RH for all device containers or

24 h at 100 °C +5 °C not suitable for reel or tubes.

An EIA JEDEC standard JESD22-A112 level 2 label is included on all dry bags.

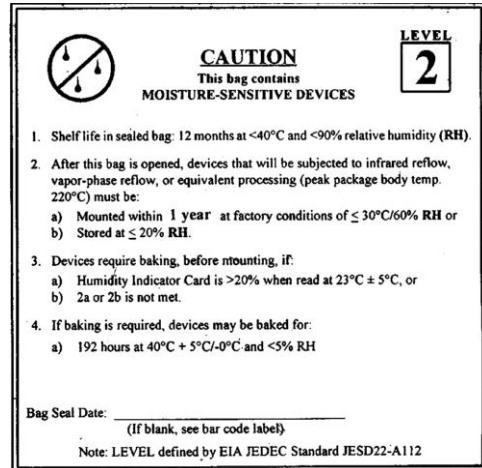

17028

Example of JESD22-A112 level 2 label

ESD PRECAUTION

Proper storage and handling procedures should be followed to prevent ESD damage to the devices especially when they are removed from the antistatic shielding bag. Electro-static sensitive devices warning labels are on the packaging.

VISHAY SEMICONDUCTORS STANDARD BAR CODE LABELS

The Vishay Semiconductors standard bar code labels are printed at final packing areas. The labels are on each packing unit and contain Vishay Semiconductors specific data.



Ozone Depleting Substances Policy Statement

It is the policy of Vishay Semiconductor GmbH to

1. Meet all present and future national and international statutory requirements.
2. Regularly and continuously improve the performance of our products, processes, distribution and operating systems with respect to their impact on the health and safety of our employees and the public, as well as their impact on the environment.

It is particular concern to control or eliminate releases of those substances into the atmosphere which are known as ozone depleting substances (ODSs).

The Montreal Protocol (1987) and its London Amendments (1990) intend to severely restrict the use of ODSs and forbid their use within the next ten years. Various national and international initiatives are pressing for an earlier ban on these substances.

Vishay Semiconductor GmbH has been able to use its policy of continuous improvements to eliminate the use of ODSs listed in the following documents.

1. Annex A, B and list of transitional substances of the Montreal Protocol and the London Amendments respectively
2. Class I and II ozone depleting substances in the Clean Air Act Amendments of 1990 by the Environmental Protection Agency (EPA) in the USA
3. Council Decision 88/540/EEC and 91/690/EEC Annex A, B and C (transitional substances) respectively.

Vishay Semiconductor GmbH can certify that our semiconductors are not manufactured with ozone depleting substances and do not contain such substances.

We reserve the right to make changes to improve technical design
and may do so without further notice.

Parameters can vary in different applications. All operating parameters must be validated for each customer application by the customer. Should the buyer use Vishay Semiconductors products for any unintended or unauthorized application, the buyer shall indemnify Vishay Semiconductors against all claims, costs, damages, and expenses, arising out of, directly or indirectly, any claim of personal damage, injury or death associated with such unintended or unauthorized use.

Vishay Semiconductor GmbH, P.O.B. 3535, D-74025 Heilbronn, Germany



Disclaimer

ALL PRODUCT, PRODUCT SPECIFICATIONS AND DATA ARE SUBJECT TO CHANGE WITHOUT NOTICE TO IMPROVE RELIABILITY, FUNCTION OR DESIGN OR OTHERWISE.

Vishay Intertechnology, Inc., its affiliates, agents, and employees, and all persons acting on its or their behalf (collectively, "Vishay"), disclaim any and all liability for any errors, inaccuracies or incompleteness contained in any datasheet or in any other disclosure relating to any product.

Vishay makes no warranty, representation or guarantee regarding the suitability of the products for any particular purpose or the continuing production of any product. To the maximum extent permitted by applicable law, Vishay disclaims (i) any and all liability arising out of the application or use of any product, (ii) any and all liability, including without limitation special, consequential or incidental damages, and (iii) any and all implied warranties, including warranties of fitness for particular purpose, non-infringement and merchantability.

Statements regarding the suitability of products for certain types of applications are based on Vishay's knowledge of typical requirements that are often placed on Vishay products in generic applications. Such statements are not binding statements about the suitability of products for a particular application. It is the customer's responsibility to validate that a particular product with the properties described in the product specification is suitable for use in a particular application. Parameters provided in datasheets and/or specifications may vary in different applications and performance may vary over time. All operating parameters, including typical parameters, must be validated for each customer application by the customer's technical experts. Product specifications do not expand or otherwise modify Vishay's terms and conditions of purchase, including but not limited to the warranty expressed therein.

Except as expressly indicated in writing, Vishay products are not designed for use in medical, life-saving, or life-sustaining applications or for any other application in which the failure of the Vishay product could result in personal injury or death. Customers using or selling Vishay products not expressly indicated for use in such applications do so at their own risk. Please contact authorized Vishay personnel to obtain written terms and conditions regarding products designed for such applications.

No license, express or implied, by estoppel or otherwise, to any intellectual property rights is granted by this document or by any conduct of Vishay. Product names and markings noted herein may be trademarks of their respective owners.

Material Category Policy

Vishay Intertechnology, Inc. hereby certifies that all its products that are identified as RoHS-Compliant fulfill the definitions and restrictions defined under Directive 2011/65/EU of The European Parliament and of the Council of June 8, 2011 on the restriction of the use of certain hazardous substances in electrical and electronic equipment (EEE) - recast, unless otherwise specified as non-compliant.

Please note that some Vishay documentation may still make reference to RoHS Directive 2002/95/EC. We confirm that all the products identified as being compliant to Directive 2002/95/EC conform to Directive 2011/65/EU.

Vishay Intertechnology, Inc. hereby certifies that all its products that are identified as Halogen-Free follow Halogen-Free requirements as per JEDEC JS709A standards. Please note that some Vishay documentation may still make reference to the IEC 61249-2-21 definition. We confirm that all the products identified as being compliant to IEC 61249-2-21 conform to JEDEC JS709A standards.