

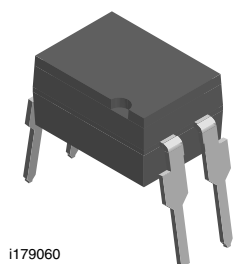

## Optocoupler, Photodarlington Output

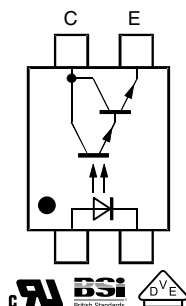

i179060



### FEATURES

- High isolation test voltage 5300 V<sub>RMS</sub>
- Standard plastic DIP-4 package
- Material categorization:  
for definitions of compliance please see [www.vishay.com/doc?99912](http://www.vishay.com/doc?99912)

RoHS  
COMPLIANT

### AGENCY APPROVALS

- UL - file no. E52744 system code H, double protection
- DIN EN 60747-5-2 (VDE 0884), IEC 60747-5-5
- DIN EN 60747-5-5 (VDE 0884) pending
- BSI IEC 60950; IEC 60065

### DESCRIPTION

The SFH655A is optically coupled isolators with a gallium arsenide infrared LED and a silicon photodarlington detector. Switching can be achieved while maintaining a high degree of isolation between driving and load circuits.

This optocouplers can be used to replace reed and mercury relays with advantages of long life, high speed switching and elimination of magnetic fields.

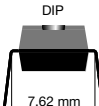
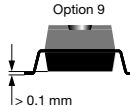
ORDERING INFORMATION	
<div style="display: flex; justify-content: space-around; align-items: center;"> <div style="border: 1px solid black; padding: 2px; margin: 2px;">S</div> <div style="border: 1px solid black; padding: 2px; margin: 2px;">F</div> <div style="border: 1px solid black; padding: 2px; margin: 2px;">H</div> <div style="border: 1px solid black; padding: 2px; margin: 2px;">6</div> <div style="border: 1px solid black; padding: 2px; margin: 2px;">#</div> <div style="border: 1px solid black; padding: 2px; margin: 2px;">#</div> <div style="border: 1px solid black; padding: 2px; margin: 2px;">A</div> <div style="border: 1px solid black; padding: 2px; margin: 2px;">-</div> <div style="border: 1px solid black; padding: 2px; margin: 2px;">#</div> <div style="border: 1px solid black; padding: 2px; margin: 2px;">#</div> <div style="border: 1px solid black; padding: 2px; margin: 2px;">#</div> <div style="border: 1px solid black; padding: 2px; margin: 2px;">#</div> </div> <p style="text-align: center;">PART NUMBER</p>	<div style="display: flex; justify-content: space-around; align-items: center;"> <div style="border: 1px solid black; padding: 2px; margin: 2px;">#</div> <div style="border: 1px solid black; padding: 2px; margin: 2px;">#</div> <div style="border: 1px solid black; padding: 2px; margin: 2px;">#</div> <div style="border: 1px solid black; padding: 2px; margin: 2px;">#</div> </div> <p style="text-align: center;">PACKAGE OPTION</p> <div style="display: flex; justify-content: space-around; align-items: center; margin-top: 10px;"> <div style="text-align: center;">  <p>DIP 7.62 mm</p> </div> <div style="text-align: center;">  <p>Option 9 &gt; 0.1 mm</p> </div> </div>
<b>AGENCY CERTIFIED/PACKAGE</b>	<b>CTR (%)</b>
cUL, VDE	> 600
DIP-4	SFH655A
SMD-4, option 9	SFH655A-X009

#### Note

- For additional information on the available options refer to option information

ABSOLUTE MAXIMUM RATINGS (T <sub>amb</sub> = 25 °C, unless otherwise specified)				
PARAMETER	TEST CONDITION	SYMBOL	VALUE	UNIT
<b>INPUT</b>				
Peak reverse voltage		V <sub>RM</sub>	6	V
Forward continuous current		I <sub>F</sub>	60	mA
Surge forward current	t <sub>p</sub> ≤ 10μs	I <sub>FSM</sub>	2.5	A
Derate linearly from 25 °C			1.33	mW/°C
Power dissipation		P <sub>diss</sub>	100	mW
<b>OUTPUT</b>				
Collector emitter breakdown voltage		BV <sub>CEO</sub>	55	V
Emitter collector breakdown voltage		BV <sub>ECO</sub>	6	V
Collector (load) current		I <sub>C</sub>	125	mA
Derate linearly from 25 °C			2	mW/°C
Power dissipation		P <sub>diss</sub>	150	mW



ABSOLUTE MAXIMUM RATINGS ( $T_{amb} = 25\text{ }^{\circ}\text{C}$ , unless otherwise specified)				
PARAMETER	TEST CONDITION	SYMBOL	VALUE	UNIT
<b>COUPLER</b>				
Derate linearly from 25 °C			3.33	mW/°C
Total power dissipation		$P_{tot}$	250	mW
Storage temperature range		$T_{stg}$	-55 to +150	°C
Operating temperature range		$T_{amb}$	-55 to +100	°C
Soldering temperature <sup>(1)</sup>	max. 10 s, dip soldering distance to seating plane $\geq 1.5$ mm	$T_{sld}$	260	°C

**Notes**

- Stresses in excess of the absolute maximum ratings can cause permanent damage to the device. Functional operation of the device is not implied at these or any other conditions in excess of those given in the operational sections of this document. Exposure to absolute maximum ratings for extended periods of the time can adversely affect reliability
- <sup>(1)</sup> Refer to reflow profile for soldering conditions for surface mounted devices (SMD). Refer to wave profile for soldering conditions for through hole devices (DIP)

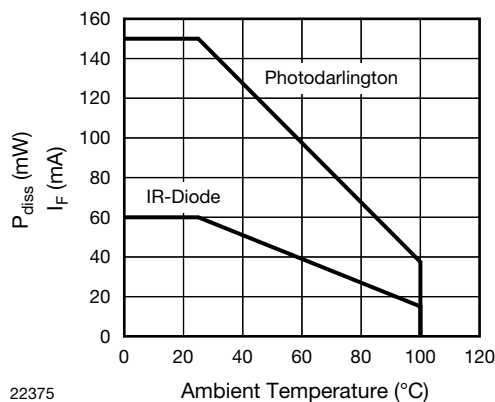

Fig. 1 - Power Dissipation vs. Ambient Temperature

ELECTRICAL CHARACTERISTICS ( $T_{amb} = 25\text{ }^{\circ}\text{C}$ , unless otherwise specified)							
PARAMETER	TEST CONDITION	PART	SYMBOL	MIN.	TYP.	MAX.	UNIT
<b>INPUT</b>							
Forward voltage	$I_F = 10\text{ mA}$		$V_F$	-	1.15	1.5	V
Reverse current	$V_R = 6\text{ V}$		$I_R$	-	0.02	10	$\mu\text{A}$
Capacitance	$V_R = 0\text{ V}$ , $f = 1\text{ MHz}$		$C_O$	-	50	-	pF
<b>OUTPUT</b>							
Collector emitter breakdown voltage	$I_{CE} = 100\text{ }\mu\text{A}$		$BV_{CEO}$	55	-	-	V
Emitter collector breakdown voltage	$I_{EC} = 10\text{ }\mu\text{A}$		$BV_{ECO}$	6	-	-	V
Collector emitter dark current	$V_{CE} = 40\text{ V}$		$I_{CEO}$	-	12	400	nA
Collector emitter capacitance	$V_{CE} = 0\text{ V}$ , $f = 1\text{ MHz}$		$C_{CE}$	-	13.5	-	pF
<b>COUPLER</b>							
Collector emitter saturation voltage	$I_F = 20\text{ mA}$ , $I_C = 5\text{ mA}$	SFH655A	$V_{CEsat}$	-	-	1	V
Coupling capacitance	$V_{I-O} = 0\text{ V}$ , $f = 1\text{ MHz}$		$C_C$	-	0.45	-	pF

**Note**

- Minimum and maximum values are testing requirements. Typical values are characteristics of the device and are the result of engineering evaluation. Typical values are for information only and are not part of the testing requirements

**CURRENT TRANSFER RATIO** ( $T_{amb} = 25\text{ }^{\circ}\text{C}$ , unless otherwise specified)

PARAMETER	TEST CONDITION	PART	SYMBOL	MIN.	TYP.	MAX.	UNIT
Current transfer ratio	$I_F = 1\text{ mA}$ , $V_{CE} = 2\text{ V}$	SFH655A	CTR	600	-	-	%

**SAFETY AND INSULATION RATINGS**

PARAMETER	TEST CONDITION	SYMBOL	VALUE	UNIT
Climatic classification	According to IEC 68 part 1		55 / 100 / 21	
Comparative tracking index		CTI	175	
Maximum rated withstanding isolation voltage	$t = 1\text{ min}$	$V_{ISO}$	4420	$V_{RMS}$
Maximum transient isolation voltage		$V_{IOTM}$	10 000	V
Maximum repetitive peak isolation voltage		$V_{IORM}$	890	V
Isolation resistance	$V_{IO} = 500\text{ V}$ , $T_{amb} = 25\text{ }^{\circ}\text{C}$	$R_{IO}$	$\geq 10^{12}$	$\Omega$
	$V_{IO} = 500\text{ V}$ , $T_{amb} = 100\text{ }^{\circ}\text{C}$	$R_{IO}$	$\geq 10^{11}$	$\Omega$
	$V_{IO} = 500\text{ V}$ , $T_{amb} = 150\text{ }^{\circ}\text{C}$ (construction test only)	$R_{IO}$	$\geq 10^9$	$\Omega$
Output safety power		$P_{SO}$	400	mW
Input safety current		$I_{SI}$	275	mA
Input safety temperature		$T_{SI}$	175	$^{\circ}\text{C}$
Creepage distance	Standard DIP-4		$\geq 7$	mm
Clearance distance	Standard DIP-4		$\geq 7$	mm
Insulation thickness		DTI	$\geq 0.4$	mm
Partial discharge test voltage - routine test	100 %, $t_{test} = 1\text{ s}$	$V_{pd}$	1.669	kV
Partial discharge test voltage - lot test (sample test)	$t_{Tr} = 60\text{ s}$ , $t_{test} = 10\text{ s}$ , (see fig. 2)	$V_{pd}$	1.424	kV

**Note**

- As per IEC 60747-5-5, § 7.4.3.8.2, this optocoupler is suitable for "safe electrical insulation" only within the safety ratings. Compliance with the safety ratings shall be ensured by means of protective circuits

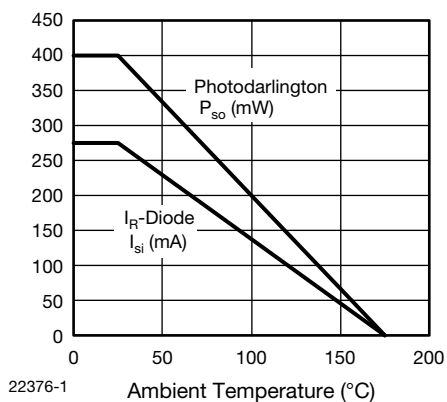

Fig. 2 - Derating Diagram

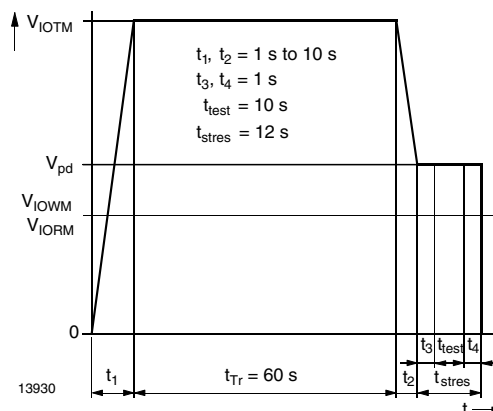

Fig. 3 - Test Pulse Diagram for Sample Test according to DIN EN 60747-5-2 (VDE 0884); IEC 60747-5-5



SWITCHING CHARACTERISTICS (T <sub>amb</sub> = 25 °C, unless otherwise specified)							
PARAMETER	TEST CONDITION	PART	SYMBOL	MIN.	TYP.	MAX.	UNIT
Turn-on time (fig. 10, test circuit 1)	V <sub>CC</sub> = 10 V, I <sub>C</sub> = 2 mA, R <sub>L</sub> = 100 Ω	SFH612A	t <sub>on</sub>		16		μs
Turn-off time (fig. 10, test circuit 1)	V <sub>CC</sub> = 10 V, I <sub>C</sub> = 2 mA, R <sub>L</sub> = 100 Ω	SFH612A	t <sub>off</sub>		15		μs
Rise time (fig. 10, test circuit 1)	V <sub>CC</sub> = 10 V, I <sub>C</sub> = 2 mA, R <sub>L</sub> = 100 Ω	SFH612A	t <sub>r</sub>		14		μs
Fall time (fig. 10, test circuit 1)	V <sub>CC</sub> = 10 V, I <sub>C</sub> = 2 mA, R <sub>L</sub> = 100 Ω	SFH612A	t <sub>f</sub>		14		μs
Turn-on time (fig. 11, test circuit 2)	V <sub>CC</sub> = 2 V, I <sub>C</sub> = 10 mA, R <sub>L</sub> = 100 Ω	SFH655A	t <sub>on</sub>		31		μs
Turn-off time (fig. 11, test circuit 2)	V <sub>CC</sub> = 2 V, I <sub>C</sub> = 10 mA, R <sub>L</sub> = 100 Ω	SFH655A	t <sub>off</sub>		55		μs
Rise time (fig. 11, test circuit 2)	V <sub>CC</sub> = 2 V, I <sub>C</sub> = 10 mA, R <sub>L</sub> = 100 Ω	SFH655A	t <sub>r</sub>		27	250	μs
Fall time (fig. 11, test circuit 2)	V <sub>CC</sub> = 2 V, I <sub>C</sub> = 10 mA, R <sub>L</sub> = 100 Ω	SFH655A	t <sub>f</sub>		56	200	μs

**TYPICAL CHARACTERISTICS** (T<sub>amb</sub> = 25 °C, unless otherwise specified)

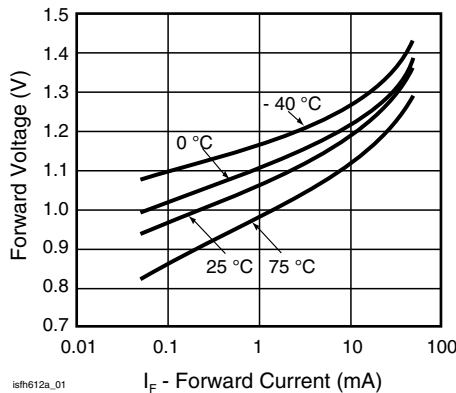

Fig. 4 - Forward Voltage vs. Forward Current

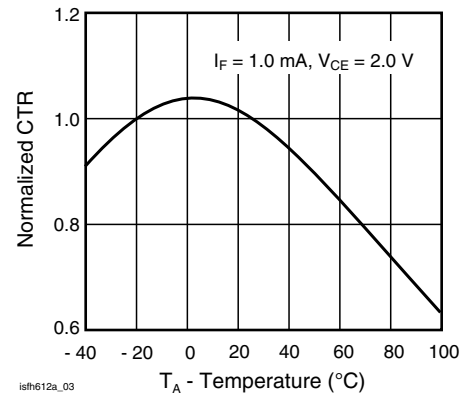

Fig. 6 - Normalized CTR vs. Temperature

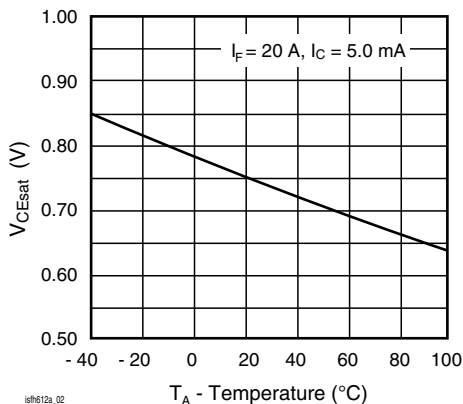

Fig. 5 - Collector Emitter Saturation Voltage vs. Temperature

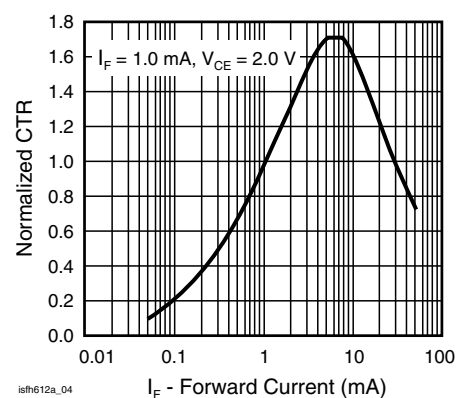

Fig. 7 - Normalized CTR vs. Forward Current

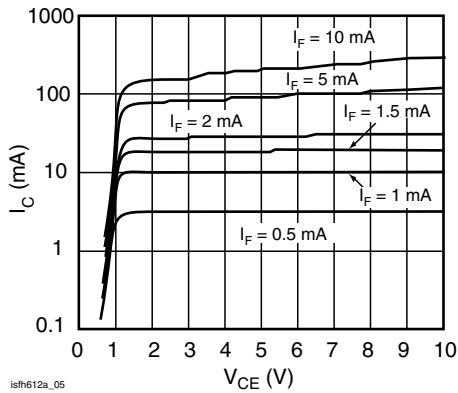

Fig. 8 - Collector Current vs. Collector Emitter Voltage

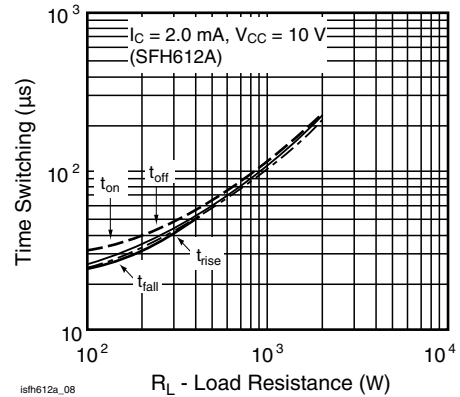

Fig. 11 - Switching Time vs. Load Resistor

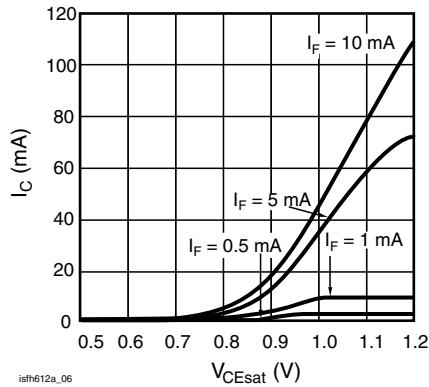

Fig. 9 - Collector Current vs. Collector Emitter Saturation Voltage

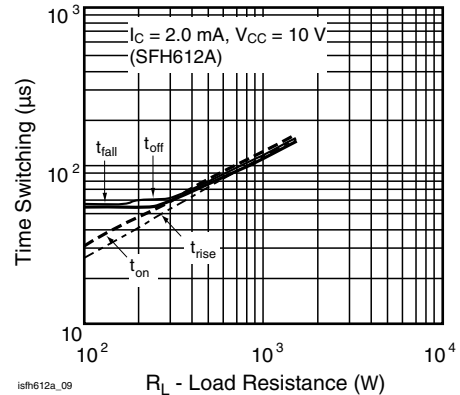

Fig. 12 - Switching Time vs. Load Resistor

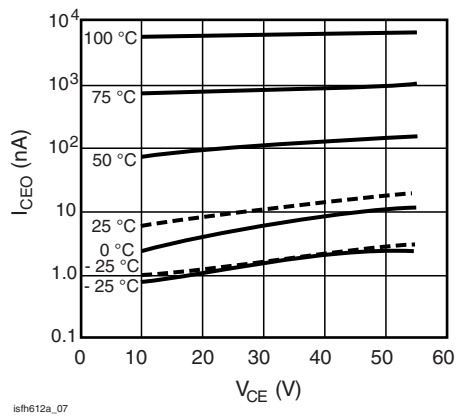
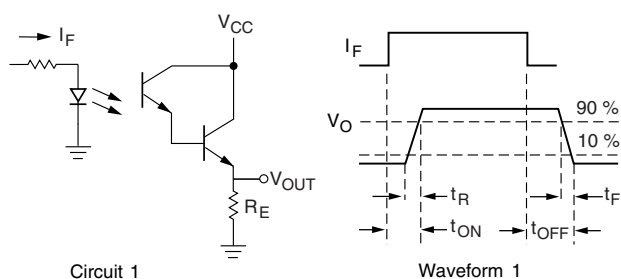

Fig. 10 - Collector Emitter Dark Current vs. Collector Emitter Voltage over Temperature



Circuit 1

Waveform 1

isfh612a\_10

Fig. 13 - Switching Time Test Circuit and Waveforms

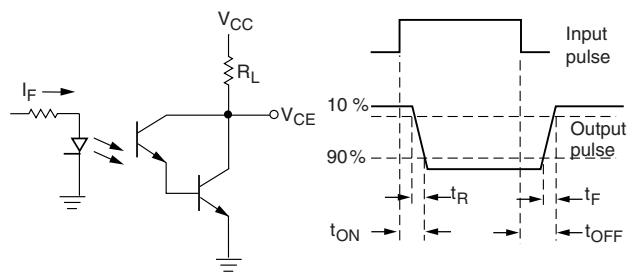

Circuit 2

Waveform 2

isfh612a\_11

Fig. 14 - Switching Time Test Circuit and Waveforms

**PACKAGE DIMENSIONS** in millimeters

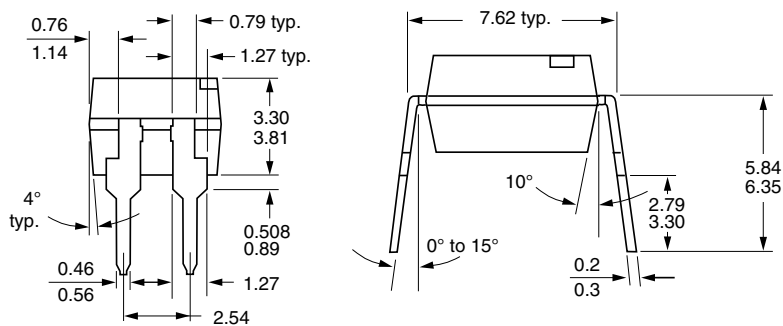
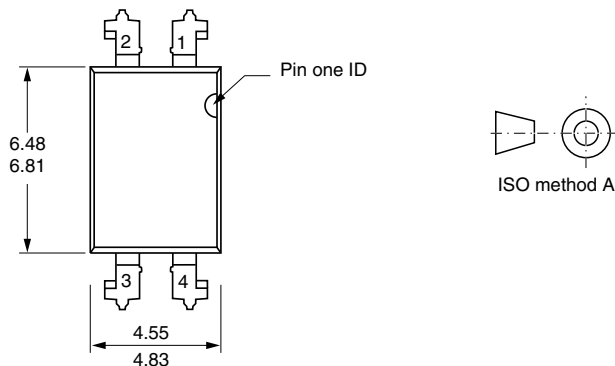

i178027

**Option 9**

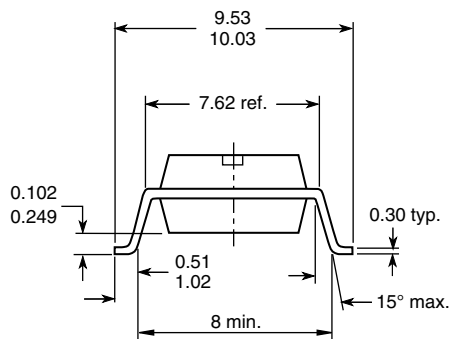

18449



**PACKAGE MARKING**

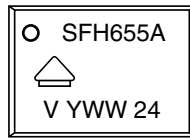

**Note**

- VDE logo is only printed on option 1 parts. Option information is not marked on the part



## Footprint and Schematic Information for SFH655A

The footprint and schematic symbols for the following parts can be accessed using the associated links. They are available in Eagle, Altium, KiCad, OrCAD / Allegro, Pulsonix, and PADS.

Note that the 3D models for these parts can be found on the Vishay product page.

PART NUMBER	FOOTPRINT / SCHEMATIC
SFH655A	<a href="http://www.snapeda.com/parts/SFH655A/Vishay/view-part">www.snapeda.com/parts/SFH655A/Vishay/view-part</a>
SFH655A-X009	<a href="http://www.snapeda.com/parts/SFH655A-X009/Vishay/view-part">www.snapeda.com/parts/SFH655A-X009/Vishay/view-part</a>

For technical issues and product support, please contact [optocoupleranswers@vishay.com](mailto:optocoupleranswers@vishay.com).

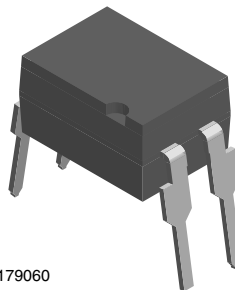





## **Disclaimer**

ALL PRODUCT, PRODUCT SPECIFICATIONS AND DATA ARE SUBJECT TO CHANGE WITHOUT NOTICE TO IMPROVE RELIABILITY, FUNCTION OR DESIGN OR OTHERWISE.

Vishay Intertechnology, Inc., its affiliates, agents, and employees, and all persons acting on its or their behalf (collectively, "Vishay"), disclaim any and all liability for any errors, inaccuracies or incompleteness contained in any datasheet or in any other disclosure relating to any product.

Vishay makes no warranty, representation or guarantee regarding the suitability of the products for any particular purpose or the continuing production of any product. To the maximum extent permitted by applicable law, Vishay disclaims (i) any and all liability arising out of the application or use of any product, (ii) any and all liability, including without limitation special, consequential or incidental damages, and (iii) any and all implied warranties, including warranties of fitness for particular purpose, non-infringement and merchantability.

Statements regarding the suitability of products for certain types of applications are based on Vishay's knowledge of typical requirements that are often placed on Vishay products in generic applications. Such statements are not binding statements about the suitability of products for a particular application. It is the customer's responsibility to validate that a particular product with the properties described in the product specification is suitable for use in a particular application. Parameters provided in datasheets and / or specifications may vary in different applications and performance may vary over time. All operating parameters, including typical parameters, must be validated for each customer application by the customer's technical experts. Product specifications do not expand or otherwise modify Vishay's terms and conditions of purchase, including but not limited to the warranty expressed therein.

Hyperlinks included in this datasheet may direct users to third-party websites. These links are provided as a convenience and for informational purposes only. Inclusion of these hyperlinks does not constitute an endorsement or an approval by Vishay of any of the products, services or opinions of the corporation, organization or individual associated with the third-party website. Vishay disclaims any and all liability and bears no responsibility for the accuracy, legality or content of the third-party website or for that of subsequent links.

Except as expressly indicated in writing, Vishay products are not designed for use in medical, life-saving, or life-sustaining applications or for any other application in which the failure of the Vishay product could result in personal injury or death. Customers using or selling Vishay products not expressly indicated for use in such applications do so at their own risk. Please contact authorized Vishay personnel to obtain written terms and conditions regarding products designed for such applications.

No license, express or implied, by estoppel or otherwise, to any intellectual property rights is granted by this document or by any conduct of Vishay. Product names and markings noted herein may be trademarks of their respective owners.