

Ultrabright LED, \varnothing 5 mm Untinted Non-Diffused

Description

The TLC.58.. series is a clear, non diffused 5 mm LED for high end applications where supreme luminous intensity and a very small emission angle is required. These lamps with clear untinted plastic case utilize the highly developed ultrabright AlInGaP and GaP technologies.

The very small viewing angle of these devices provide a very high luminous intensity.

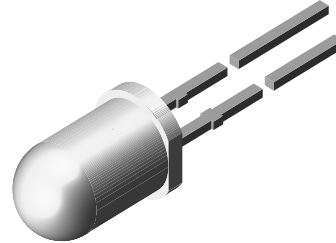

19223



Features

- Untinted non diffused lens
- Utilizing ultrabright AlInGaP and InGaN technology
- Very high luminous intensity
- Very small emission angle
- High operating temperature:
T_j (chip junction temperature)
up to 125 °C for AlInGaP devices
- Luminous intensity and color categorized for each packing unit
- ESD-withstand voltage: 2 kV acc. to MIL STD 883 D, Method 3015.7 for AlInGaP, 1 kV for InGaN
- Lead-free device

Applications

- Interior and exterior lighting
- Outdoor LED panels, displays
- Instrumentation and front panel indicators
- Central high mounted stop lights (CHMSL) for motor vehicles
- Replaces incandescent lamps
- Traffic signals and signs
- Light guide design

Parts Table

Part	Color, Luminous Intensity	Angle of Half Intensity ($\pm\phi$)	Technology
TLCR5800	Red, I _v > 7500 mcd	4 °	AlInGaP on GaAs
TLCY5800	Yellow, I _v > 5750 mcd	4 °	AlInGaP on GaAs
TLCTG5800	True green, I _v > 2400 mcd	4 °	InGaN on SiC
TLCB5800	Blue, I _v > 750 mcd	4 °	InGaN on SiC

Absolute Maximum Ratings

T_{amb} = 25 °C, unless otherwise specified

TLCR5800 , TLCY5800 , TLCTG5800 , TLCB5800

Parameter	Test condition	Part	Symbol	Value	Unit
Reverse voltage			V _R	5	V
DC Forward current	T _{amb} ≤ 85°C	TLCR5800	I _F	50	mA
		TLCY5800	I _F	50	mA
	T _{amb} ≤ 60°C	TLCTG5800	I _F	30	mA
		TLCB5800	I _F	30	mA

Parameter	Test condition	Part	Symbol	Value	Unit
Surge forward current	$t_p \leq 10 \mu\text{s}$	TLCR5800	I_{FSM}	1	A
		TLCY5800	I_{FSM}	1	A
		TLCTG5800	I_{FSM}	0.1	A
		TLCB5800	I_{FSM}	0.1	A
Power dissipation	$T_{amb} \leq 85^\circ\text{C}$	TLCR5800	P_V	135	mW
		TLCY5800	P_V	135	mW
	$T_{amb} \leq 60^\circ\text{C}$	TLCTG5800	P_V	135	mW
		TLCB5800	P_V	135	mW
Junction temperature		TLCR5800	T_j	125	$^\circ\text{C}$
		TLCY5800	T_j	125	$^\circ\text{C}$
		TLCTG5800	T_j	100	$^\circ\text{C}$
		TLCB5800	T_j	100	$^\circ\text{C}$
Operating temperature range			T_{amb}	- 40 to + 100	$^\circ\text{C}$
Storage temperature range			T_{stg}	- 40 to + 100	$^\circ\text{C}$
Soldering temperature	$t \leq 5 \text{ s}$, 2 mm from body		T_{sd}	260	$^\circ\text{C}$
Thermal resistance junction/ambient			R_{thJA}	300	K/W

Optical and Electrical Characteristics

$T_{amb} = 25^\circ\text{C}$, unless otherwise specified

Red

TLCR5800

Parameter	Test condition	Part	Symbol	Min	Typ.	Max	Unit
Luminous intensity ¹⁾	$I_F = 50 \text{ mA}$	TLCR5800	I_V	7500	20000		
Dominant wavelength	$I_F = 50 \text{ mA}$		λ_d	611	616	622	nm
Peak wavelength	$I_F = 50 \text{ mA}$		λ_p		622		nm
Spectral bandwidth at 50 % $I_{rel \text{ max}}$	$I_F = 50 \text{ mA}$		$\Delta\lambda$		18		nm
Angle of half intensity	$I_F = 50 \text{ mA}$		φ		± 4		deg
Forward voltage	$I_F = 50 \text{ mA}$		V_F		2.1	2.7	V
Reverse voltage	$I_R = 10 \mu\text{A}$		V_R	5			V
Temperature coefficient of V_F	$I_F = 50 \text{ mA}$		TC_{VF}		- 3.5		mV/K
Temperature coefficient of λ_d	$I_F = 50 \text{ mA}$		$TC_{\lambda d}$		0.05		nm/K

¹⁾ in one Packing Unit $I_{Vmax}/I_{Vmin} \leq 2.0$



Yellow

TLCY5800

Parameter	Test condition	Part	Symbol	Min	Typ.	Max	Unit
Luminous intensity ¹⁾	I _F = 50 mA	TLCY5800	I _V	5750	14000		mcd
Dominant wavelength	I _F = 50 mA		λ _d	585	590	597	nm
Peak wavelength	I _F = 50 mA		λ _p		593		nm
Spectral bandwidth at 50 % I _{rel} max	I _F = 50 mA		Δλ		17		nm
Angle of half intensity	I _F = 50 mA		φ		± 4		deg
Forward voltage	I _F = 50 mA		V _F		2.1	2.7	V
Reverse voltage	I _R = 10 μA		V _R	5			V
Temperature coefficient of V _F	I _F = 50 mA		TC _{V_F}		- 3.5		mV/K
Temperature coefficient of λ _d	I _F = 50 mA		TC _{λ_d}		0.1		nm/K

¹⁾ in one Packing Unit I_{Vmax}/I_{Vmin} ≤ 2.0

True green

Parameter	Test condition	Part	Symbol	Min	Typ.	Max	Unit
Luminous intensity ¹⁾	I _F = 30 mA	TLCTG5800	I _V	2400	7000		mcd
Dominant wavelength	I _F = 30 mA		λ _d	515	525	535	nm
Peak wavelength	I _F = 30 mA		λ _p		520		nm
Spectral bandwidth at 50 % I _{rel} max	I _F = 30 mA		Δλ		37		nm
Angle of half intensity	I _F = 30 mA		φ		± 4		deg
Forward voltage	I _F = 30 mA		V _F		3.9	4.5	V
Reverse voltage	I _R = 10 μA		V _R	5			V
Temperature coefficient of V _F	I _F = 30 mA		TC _{V_F}		- 4.5		mV/K
Temperature coefficient of λ _d	I _F = 30 mA		TC _{λ_d}		0.02		nm/K

¹⁾ in one Packing Unit I_{Vmax}/I_{Vmin} ≤ 2.0

Blue

TLCB5800

Parameter	Test condition	Part	Symbol	Min	Typ.	Max	Unit
Luminous intensity ¹⁾	I _F = 30 mA	TLCB5800	I _V	750	2500		mcd
Dominant wavelength	I _F = 30 mA		λ _d	462	470	476	nm
Peak wavelength	I _F = 30 mA		λ _p		464		nm
Spectral bandwidth at 50 % I _{rel} max	I _F = 30 mA		Δλ		25		nm
Angle of half intensity	I _F = 30 mA		φ		± 4		deg
Forward voltage	I _F = 30 mA		V _F		3.9	4.5	V
Reverse voltage	I _R = 10 μA		V _R	5			V
Temperature coefficient of V _F	I _F = 30 mA		TC _{V_F}		- 5.0		mV/K
Temperature coefficient of λ _d	I _F = 30 mA		TC _{λ_d}		0.02		nm/K

¹⁾ in one Packing Unit I_{Vmax}/I_{Vmin} ≤ 2.0

Typical Characteristics ($T_{amb} = 25\text{ }^{\circ}\text{C}$ unless otherwise specified)

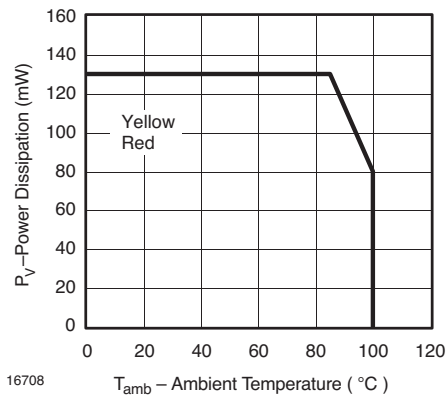

Figure 1. Power Dissipation vs. Ambient Temperature

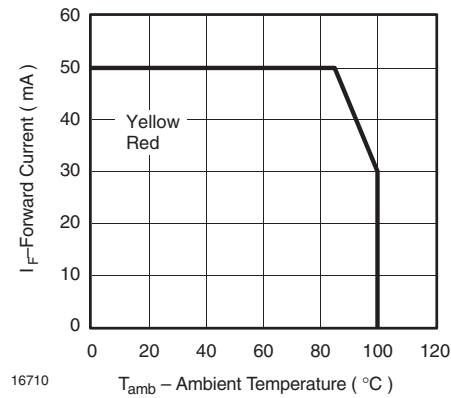

Figure 4. Forward Current vs. Ambient Temperature

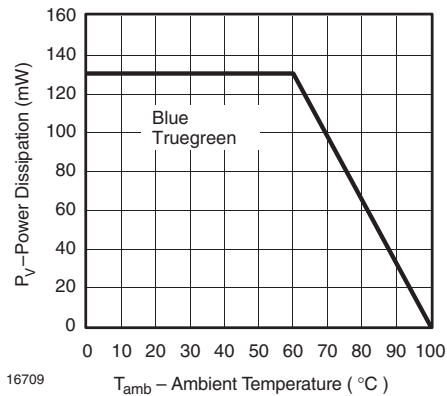

Figure 2. Power Dissipation vs. Ambient Temperature

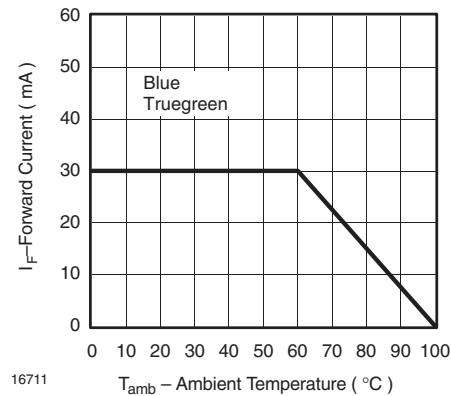

Figure 5. Forward Current vs. Ambient Temperature

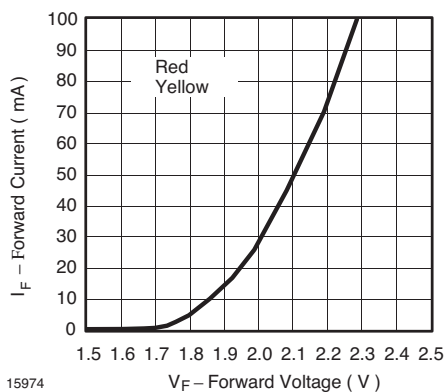

Figure 3. Forward Current vs. Forward Voltage

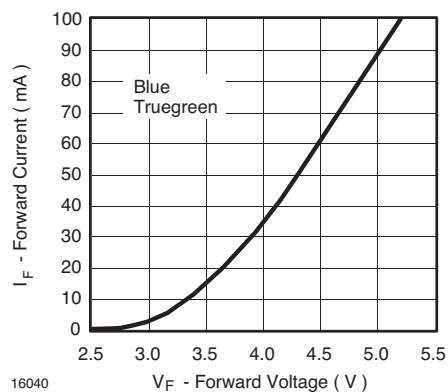

Figure 6. Forward Current vs. Forward Voltage

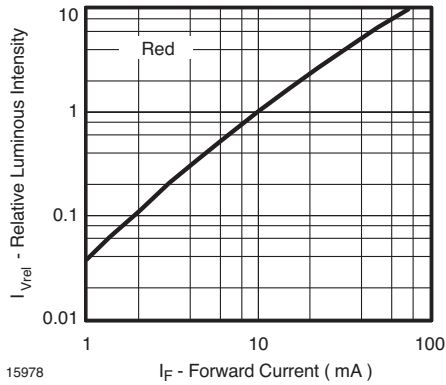

Figure 7. Relative Luminous Flux vs. Forward Current

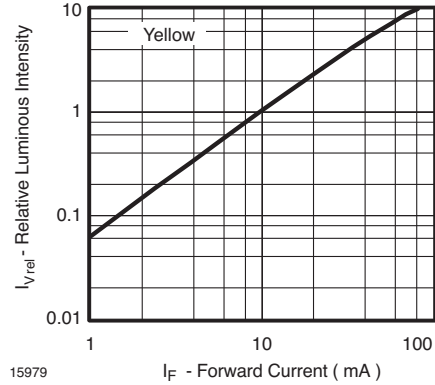

Figure 10. Relative Luminous Flux vs. Forward Current

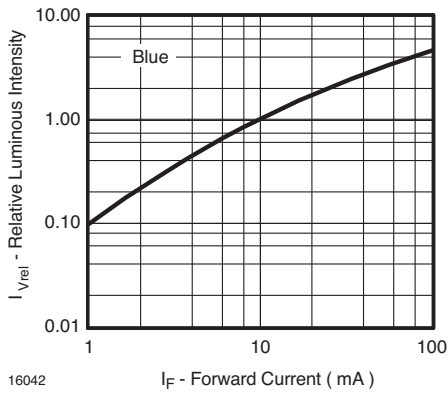

Figure 8. Relative Luminous Flux vs. Forward Current

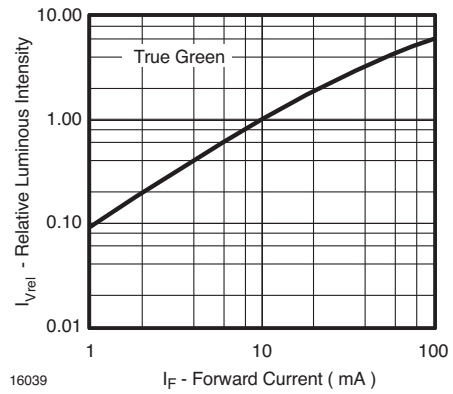

Figure 11. Relative Luminous Flux vs. Forward Current

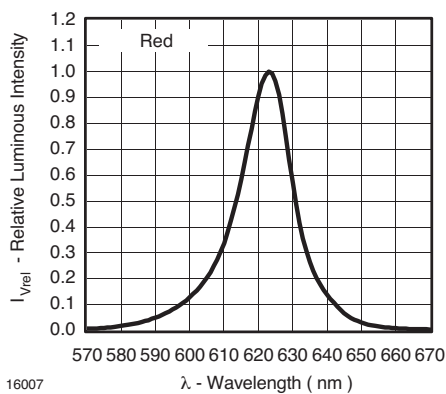

Figure 9. Relative Intensity vs. Wavelength

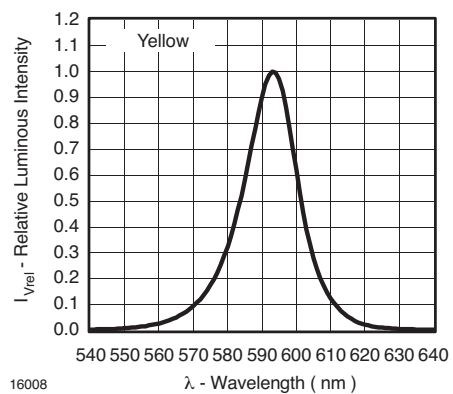

Figure 12. Relative Intensity vs. Wavelength

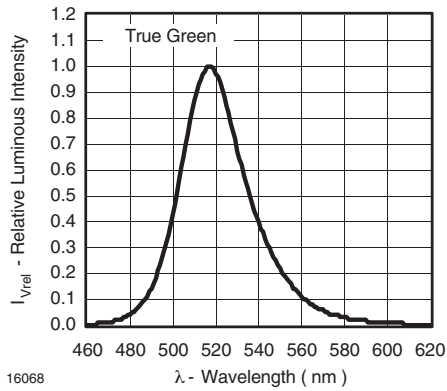

Figure 13. Relative Intensity vs. Wavelength

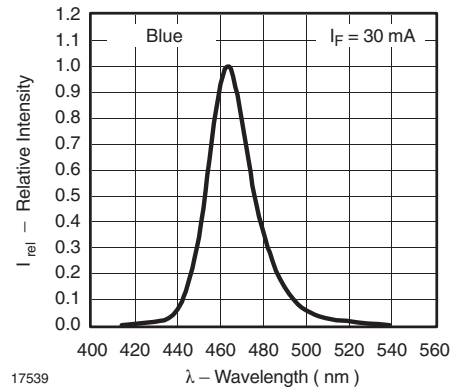
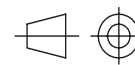
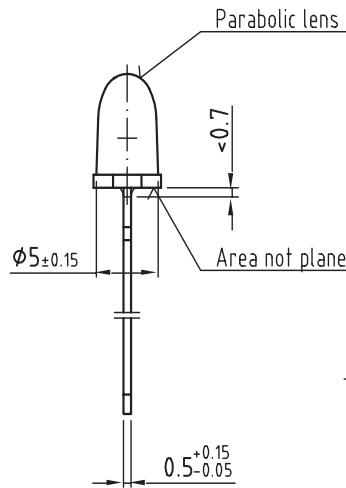
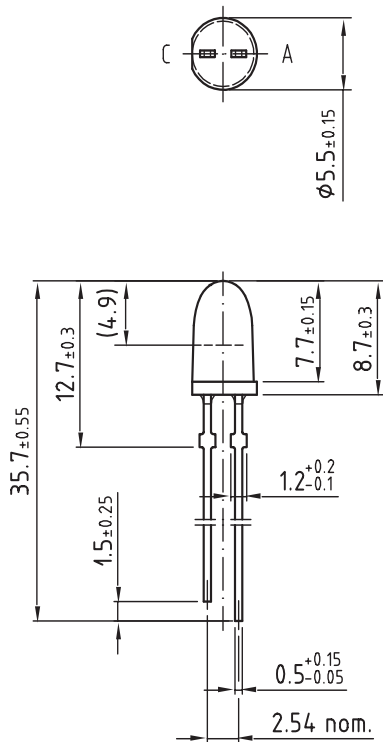

Figure 14. Relative Intensity vs. Wavelength

Package Dimensions in mm



technical drawings
according to DIN
specifications

All dimensions in mm

Drawing-No.: 6.544-5310.01-4
Issue: 2; 04.07.03

95 11476



Ozone Depleting Substances Policy Statement

It is the policy of **Vishay Semiconductor GmbH** to

1. Meet all present and future national and international statutory requirements.
2. Regularly and continuously improve the performance of our products, processes, distribution and operating systems with respect to their impact on the health and safety of our employees and the public, as well as their impact on the environment.

It is particular concern to control or eliminate releases of those substances into the atmosphere which are known as ozone depleting substances (ODSs).

The Montreal Protocol (1987) and its London Amendments (1990) intend to severely restrict the use of ODSs and forbid their use within the next ten years. Various national and international initiatives are pressing for an earlier ban on these substances.

Vishay Semiconductor GmbH has been able to use its policy of continuous improvements to eliminate the use of ODSs listed in the following documents.

1. Annex A, B and list of transitional substances of the Montreal Protocol and the London Amendments respectively
2. Class I and II ozone depleting substances in the Clean Air Act Amendments of 1990 by the Environmental Protection Agency (EPA) in the USA
3. Council Decision 88/540/EEC and 91/690/EEC Annex A, B and C (transitional substances) respectively.

Vishay Semiconductor GmbH can certify that our semiconductors are not manufactured with ozone depleting substances and do not contain such substances.

**We reserve the right to make changes to improve technical design
and may do so without further notice.**

Parameters can vary in different applications. All operating parameters must be validated for each customer application by the customer. Should the buyer use Vishay Semiconductors products for any unintended or unauthorized application, the buyer shall indemnify Vishay Semiconductors against all claims, costs, damages, and expenses, arising out of, directly or indirectly, any claim of personal damage, injury or death associated with such unintended or unauthorized use.

Vishay Semiconductor GmbH, P.O.B. 3535, D-74025 Heilbronn, Germany
Telephone: 49 (0)7131 67 2831, Fax number: 49 (0)7131 67 2423



Notice

Specifications of the products displayed herein are subject to change without notice. Vishay Intertechnology, Inc., or anyone on its behalf, assumes no responsibility or liability for any errors or inaccuracies.

Information contained herein is intended to provide a product description only. No license, express or implied, by estoppel or otherwise, to any intellectual property rights is granted by this document. Except as provided in Vishay's terms and conditions of sale for such products, Vishay assumes no liability whatsoever, and disclaims any express or implied warranty, relating to sale and/or use of Vishay products including liability or warranties relating to fitness for a particular purpose, merchantability, or infringement of any patent, copyright, or other intellectual property right.

The products shown herein are not designed for use in medical, life-saving, or life-sustaining applications. Customers using or selling these products for use in such applications do so at their own risk and agree to fully indemnify Vishay for any damages resulting from such improper use or sale.