

High Intensity LED in Ø 3 mm Tinted Diffused Package

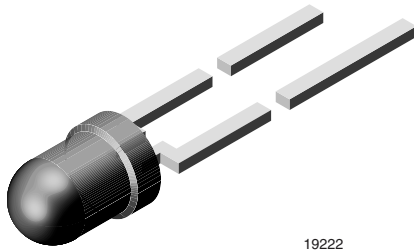

19222

DESCRIPTION

This device has been designed to meet the increasing demand for AllnGaP technology general indicating and lighting purposes.

It is housed in a 3 mm diffused plastic package. The wide viewing angle of these devices provides a high brightness.

All packing units are categorized in luminous intensity and color groups. That allows users to assemble LEDs with uniform appearance developed for standard applications like general indicating and lighting purposes.

FEATURES

- AllnGaP technology
- Standard Ø 3 mm (T-1) package
- Small mechanical tolerances
- Suitable for DC and high peak current
- Wide viewing angle
- Very high intensity
- Luminous intensity color categorized
- Material categorization:
for definitions of compliance please see www.vishay.com/doc?99912



APPLICATIONS

- Status lights
- Off / on indicator
- Background illumination
- Readout lights
- Maintenance lights
- Legend light

PRODUCT GROUP AND PACKAGE DATA

- Product group: LED
- Package: 3 mm
- Product series: standard
- Angle of half intensity: $\pm 60^\circ$

PARTS TABLE

PART	COLOR	LUMINOUS INTENSITY (mcd)			at I _F (mA)	WAVELENGTH (nm)			at I _F (mA)	FORWARD VOLTAGE (V)			at I _F (mA)	TECHNOLOGY
		MIN.	TYP.	MAX.		MIN.	TYP.	MAX.		MIN.	TYP.	MAX.		
TLHE4600	Yellow	10	26	-	10	581	588	594	10	-	1.9	2.6	20	AllnGaP on GaAs

ABSOLUTE MAXIMUM RATINGS (T_{amb} = 25 °C, unless otherwise specified)

TLHE4600

PARAMETER	TEST CONDITION	SYMBOL	VALUE	UNIT
Reverse voltage		V _R	5	V
DC forward current	T _{amb} ≤ 60 °C	I _F	30	mA
Surge forward current	t _p ≤ 10 μs	I _{FSM}	0.1	A
Power dissipation	T _{amb} ≤ 60 °C	P _V	80	mW
Junction temperature		T _J	100	°C
Operating temperature range		T _{amb}	-40 to +100	°C
Storage temperature range		T _{stg}	-55 to +100	°C
Soldering temperature	t ≤ 5 s, 2 mm from body	T _{sd}	260	°C
Thermal resistance junction/ambient		R _{thJA}	400	K/W

**OPTICAL AND ELECTRICAL CHARACTERISTICS** ($T_{amb} = 25\text{ }^{\circ}\text{C}$, unless otherwise specified)
TLHE4600, YELLOW

PARAMETER	TEST CONDITION	SYMBOL	MIN	TYP.	MAX	UNIT
Luminous intensity ⁽¹⁾	$I_F = 10\text{ mA}$	I_V	10	26	-	mcd
Dominant wavelength	$I_F = 10\text{ mA}$	λ_d	581	588	594	nm
Peak wavelength	$I_F = 10\text{ mA}$	λ_p	-	590	-	nm
Angle of half intensity	$I_F = 10\text{ mA}$	ϕ	-	± 60	-	deg
Forward voltage	$I_F = 20\text{ mA}$	V_F	-	1.9	2.6	V
Reverse voltage	$I_R = 10\text{ }\mu\text{A}$	V_R	5	-	-	V
Junction capacitance	$V_R = 0\text{ V}$, $f = 1\text{ MHz}$	C_j	-	15	-	pF

Note

(1) In one packing unit $I_{Vmin}/I_{Vmax} \leq 0.5$.

LUMINOUS INTENSITY CLASSIFICATION

GROUP	LIGHT INTENSITY (mcd)	
	MIN.	MAX.
R	10	20
S	16	32
T	25	50
U	40	80
V	63	125
W	100	200
X	130	260
Y	180	360
Z	240	480

Note

- Luminous intensity is tested at a current pulse duration of 25 ms. These type numbers represent the order groups which include only a few brightness groups. Only one group will be shipped on each reel (there will be no mixing of two groups on each reel). In order to ensure availability, single brightness groups are not be orderable.
In a similar manner for colors where wavelength groups are measured and binned, single wavelength groups will be shipped on any one reel.
In order to ensure availability, single wavelength groups are not be orderable.

COLOR CLASSIFICATION

GROUP	YELLOW	
	DOM. WAVELENGTH (nm)	
	MIN.	MAX.
1	581	584
2	583	586
3	585	588
4	587	590
5	589	592
6	591	594

Note

- Wavelengths are tested at a current pulse duration of 25 ms.

TYPICAL CHARACTERISTICS ($T_{amb} = 25\text{ }^{\circ}\text{C}$, unless otherwise specified)

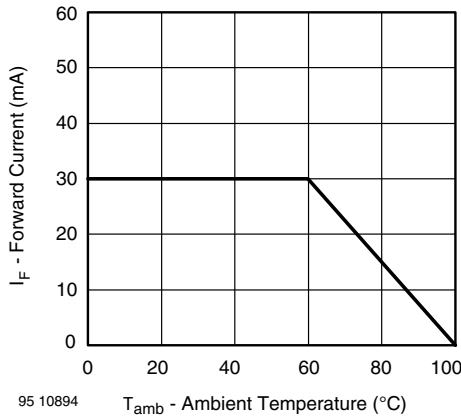

Fig. 1 - Forward Current vs. Ambient Temperature for InGaN

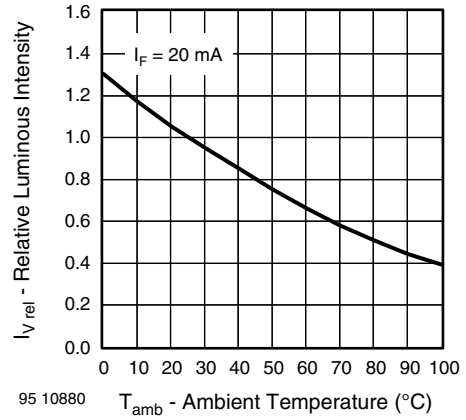

Fig. 4 - Relative Luminous Intensity vs. Ambient Temperature

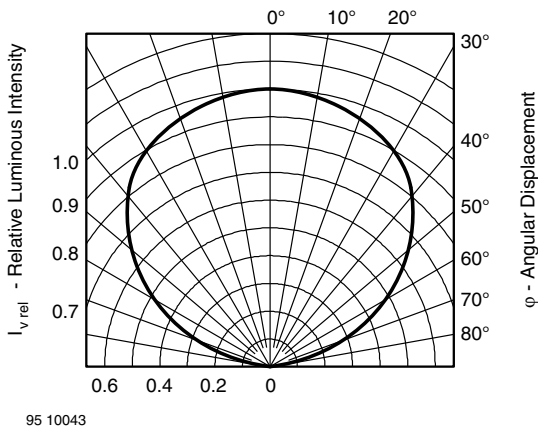

Fig. 2 - Relative Luminous Intensity vs. Angular Displacement

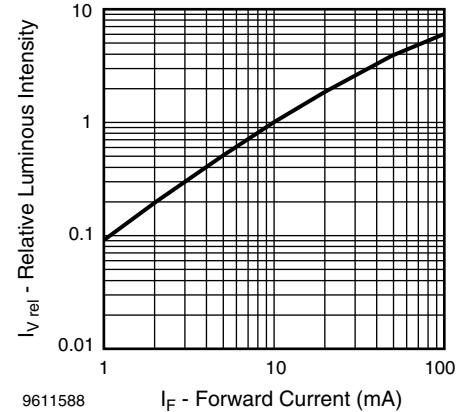

Fig. 5 - Relative Luminous Intensity vs. Forward Current

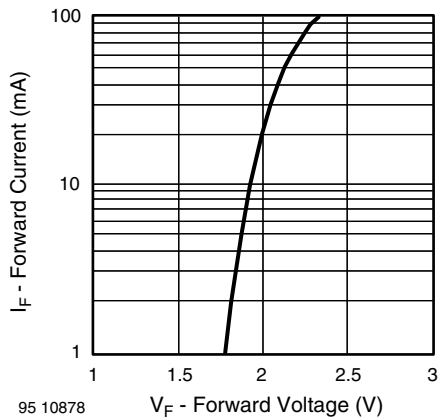

Fig. 3 - Forward Current vs. Forward Voltage

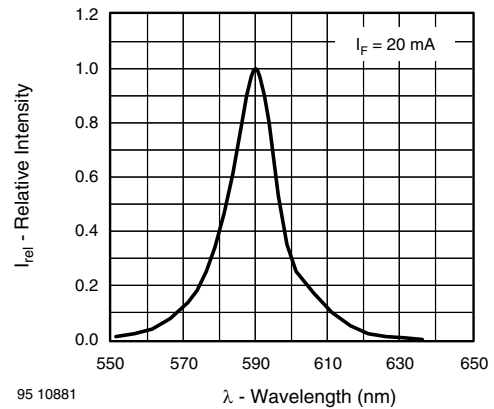
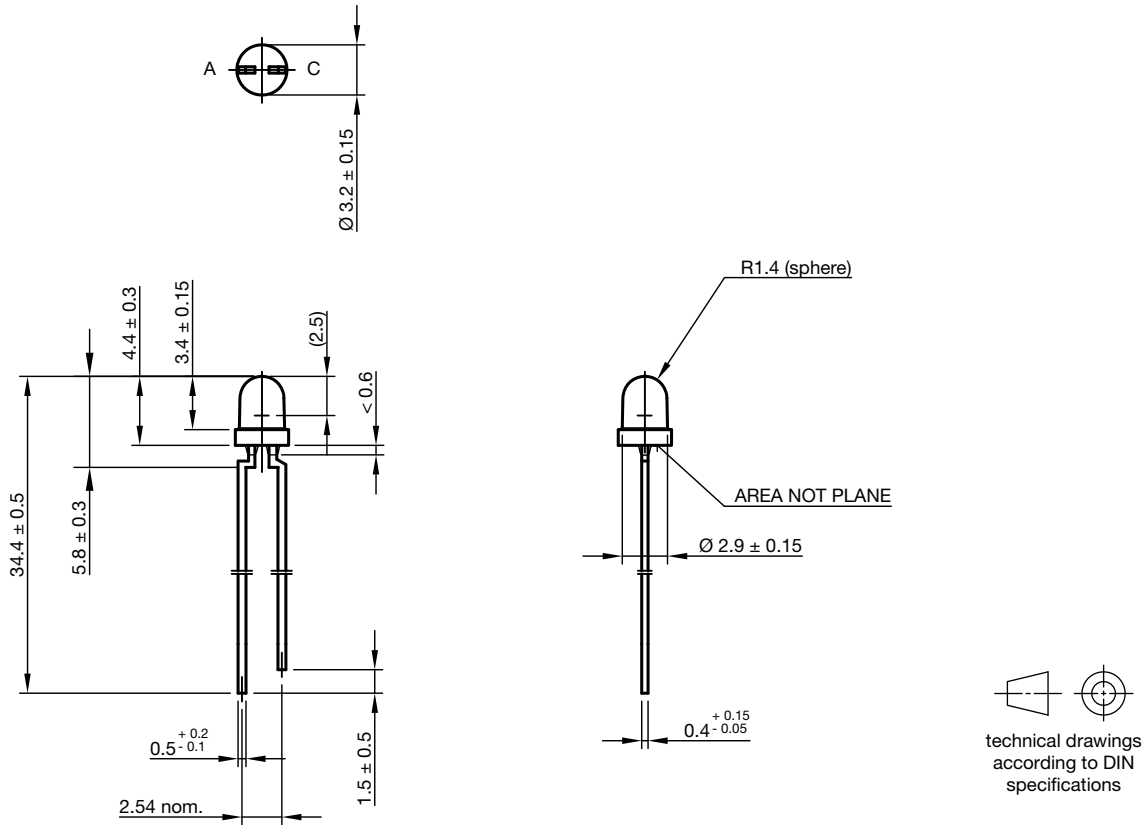

Fig. 6 - Relative Intensity vs. Wavelength



PACKAGE DIMENSIONS in millimeters



Drawing-No.: 6.544-5255.01-4
Issue: 9; 28.07.14



Disclaimer

ALL PRODUCT, PRODUCT SPECIFICATIONS AND DATA ARE SUBJECT TO CHANGE WITHOUT NOTICE TO IMPROVE RELIABILITY, FUNCTION OR DESIGN OR OTHERWISE.

Vishay Intertechnology, Inc., its affiliates, agents, and employees, and all persons acting on its or their behalf (collectively, "Vishay"), disclaim any and all liability for any errors, inaccuracies or incompleteness contained in any datasheet or in any other disclosure relating to any product.

Vishay makes no warranty, representation or guarantee regarding the suitability of the products for any particular purpose or the continuing production of any product. To the maximum extent permitted by applicable law, Vishay disclaims (i) any and all liability arising out of the application or use of any product, (ii) any and all liability, including without limitation special, consequential or incidental damages, and (iii) any and all implied warranties, including warranties of fitness for particular purpose, non-infringement and merchantability.

Statements regarding the suitability of products for certain types of applications are based on Vishay's knowledge of typical requirements that are often placed on Vishay products in generic applications. Such statements are not binding statements about the suitability of products for a particular application. It is the customer's responsibility to validate that a particular product with the properties described in the product specification is suitable for use in a particular application. Parameters provided in datasheets and / or specifications may vary in different applications and performance may vary over time. All operating parameters, including typical parameters, must be validated for each customer application by the customer's technical experts. Product specifications do not expand or otherwise modify Vishay's terms and conditions of purchase, including but not limited to the warranty expressed therein.

Hyperlinks included in this datasheet may direct users to third-party websites. These links are provided as a convenience and for informational purposes only. Inclusion of these hyperlinks does not constitute an endorsement or an approval by Vishay of any of the products, services or opinions of the corporation, organization or individual associated with the third-party website. Vishay disclaims any and all liability and bears no responsibility for the accuracy, legality or content of the third-party website or for that of subsequent links.

Except as expressly indicated in writing, Vishay products are not designed for use in medical, life-saving, or life-sustaining applications or for any other application in which the failure of the Vishay product could result in personal injury or death. Customers using or selling Vishay products not expressly indicated for use in such applications do so at their own risk. Please contact authorized Vishay personnel to obtain written terms and conditions regarding products designed for such applications.

No license, express or implied, by estoppel or otherwise, to any intellectual property rights is granted by this document or by any conduct of Vishay. Product names and markings noted herein may be trademarks of their respective owners.