

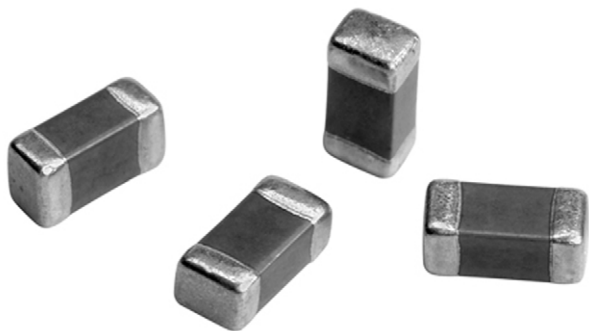

## Surface Mount Multilayer Ceramic Chip Capacitors for High Q Commodity Applications



### FEATURES

- Ultra stable class 1 dielectric
- High Q and low ESR at high frequency
- Four standard sizes
- High capacitance per unit volume
- Supplied in tape on reel
- For high frequency applications
- Ni-barrier with 100 % tin terminations
- Dry sheet manufacturing technology
- Material categorization: for definitions of compliance please see [www.vishay.com/doc?99912](http://www.vishay.com/doc?99912)



**RoHS**  
COMPLIANT  
HALOGEN  
**FREE**  
**GREEN**  
(5-2008)

### APPLICATIONS

- Mobile telecommunication
- WLAN
- RF modules
- Tuner

### ELECTRICAL SPECIFICATIONS

#### Note

- Electrical characteristics at 25 °C, 30 % to 70 % related humidity, unless otherwise specified

**Operating Temperature:** - 55 °C to + 125 °C

**Capacitance Range:** 0.5 pF to 3300 pF

**Voltage Range:** 16 V<sub>DC</sub> to 100 V<sub>DC</sub>

**Temperature Coefficient of Capacitance (TCC):**

± 30 ppm/°C from - 55 °C to + 125 °C

**Dissipation Factor:**

Cap. < 30 pF: Q ≥ 400 + 20 C

Cap. ≥ 30 pF: Q ≥ 1000

**Test Conditions for Capacitance and DF Measurement**

Cap. ≤ 1000 pF 1.0 V<sub>RMS</sub> ± 0.2 V<sub>RMS</sub>, 1 MHz ± 10 %

Cap. > 1000 pF 1.0 V<sub>RMS</sub> ± 0.2 V<sub>RMS</sub>, 1 kHz ± 10 %

**Aging Rate:** 0 % maximum per decade

**Insulation Resistance (IR):** after 120 s at U<sub>R</sub> (DC)  
≥ 10 GΩ or R x C ≥ 500 Ω x F whichever is less

**Dielectric Strength Test:**

This is the maximum voltage the capacitors are tested for 1 s to 5 s period and the charge/discharge current does not exceed 50 mA

≤ 100 V<sub>DC</sub>: DWV at 250 % of rated voltage



QUICK REFERENCE DATA				
DIELECTRIC	CASE	MAXIMUM VOLTAGE (V)	CAPACITANCE	
			MINIMUM	MAXIMUM
High Q	0402	50	0.5 pF	470 pF
	0603	100	0.5 pF	3.3 nF

**Note**

- Detail ratings see selection chart

ORDERING INFORMATION							
VJ0402	Q	101	F	X	J	C	W1BC
SIZE CODE	DIELECTRIC	CAPACITANCE	TOLERANCE	TERMINATION	VOLTAGE	PACKAGING	PROCESS CODE FOR BASIC COMMODITY
0402 0603	Q = High Q	Two significant digits followed by the number of zeros: 1R0 = 1.0 pF 101 = 100 pF	Cap. value ≤ 5 pF B = ± 0.10 pF C = ± 0.25 pF 5 pF > Cap. value < 10 pF C = ± 0.25 pF D = ± 0.50 pF Cap. value ≥ 10 pF F = ± 1 % G = ± 2 % J = ± 5 %	X = Ni barrier 100 % tin termination	J = 16 V X = 25 V A = 50 V B = 100 V	C = 7" reel / paper P = 13" reel / paper	

DIMENSIONS in inches (millimeters)				
SIZE CODE	L	W	T MAX.	MB
0402 (1005)	0.040 ± 0.002 (1.00 ± 0.05)	0.020 ± 0.002 (0.50 ± 0.05)	0.022 (0.55)	0.010 + 0.002 / - 0.004 (0.25 + 0.05 / - 0.10)
0603 (1608)	0.063 + 0.006 / - 0.004 (1.60 + 0.15 / - 0.10)	0.030 + 0.006 / - 0.004 (0.80 + 0.15 / - 0.10)	0.038 (0.95)	0.016 ± 0.006 (0.40 ± 0.15)



SELECTION CHART									
DIELECTRIC		HIGH Q							
STYLE		VJ0402				VJ0603			
SIZE CODE		0402				0603			
VOLTAGE (V <sub>DC</sub> )		16 V	25 V	50 V	100 V	16 V	25 V	50 V	100 V
VOLTAGE CODE		J	X	A	B	J	X	A	B
CAP. CODE	CAP.								
0R5	0.5 pF		N	N			S	S	S
1R0	1.0 pF		N	N			S	S	S
1R2	1.2 pF		N	N			S	S	S
1R5	1.5 pF		N	N			S	S	S
1R8	1.8 pF		N	N			S	S	S
2R2	2.2 pF		N	N			S	S	S
2R7	2.7 pF		N	N			S	S	S
3R3	3.3 pF		N	N			S	S	S
3R9	3.9 pF		N	N			S	S	S
4R7	4.7 pF		N	N			S	S	S
5R6	5.6 pF		N	N			S	S	S
6R8	6.8 pF		N	N			S	S	S
8R2	8.2 pF		N	N			S	S	S
100	10 pF		N	N			S	S	S
120	12 pF		N	N			S	S	S
150	15 pF		N	N			S	S	S
180	18 pF		N	N			S	S	S
220	22 pF		N	N			S	S	S
270	27 pF		N	N			S	S	S
330	33 pF		N	N			S	S	S
390	39 pF		N	N			S	S	S
470	47 pF		N	N			S	S	S
560	56 pF		N	N			S	S	S
680	68 pF		N	N			S	S	S
820	82 pF		N	N			S	S	S
101	100 pF		N	N			S	S	S
121	120 pF		N	N			S	S	S
151	150 pF		N	N			S	S	S
181	180 pF		N	N			S	S	S
221	220 pF		N	N			S	S	S
271	270 pF	N	N	N			S	S	S
331	330 pF	N	N	N			S	S	S
391	390 pF	N	N	N			S	S	S
471	470 pF	N	N	N			S	S	S
561	560 pF						S	S	S
681	680 pF						S	S	S
821	820 pF						S	S	S
102	1000 pF						S	S	S
122	1200 pF					X	X	X	
152	1500 pF					X	X	X	
182	1800 pF					X	X	X	
222	2200 pF					X	X	X	
272	2700 pF					X	X	X	
332	3300 pF					X	X	X	
472	4700 pF								
562	5600 pF								
682	6800 pF								
822	8200 pF								
103	10 000 pF								

**Note**

- Letters indicate product thickness, see packaging quantities



PACKAGING QUANTITIES				
SIZE CODE (inch/mm)	MAX. THICKNESS (mm)	THICKNESS SYMBOL	PAPER TAPE	
			7" REEL (C)	13" REEL (P)
0402 (1002)	0.55	N	10K	20K
0603 (1608)	0.95	S, X	4K	15K

**PAPER TAPE SPECIFICATION**

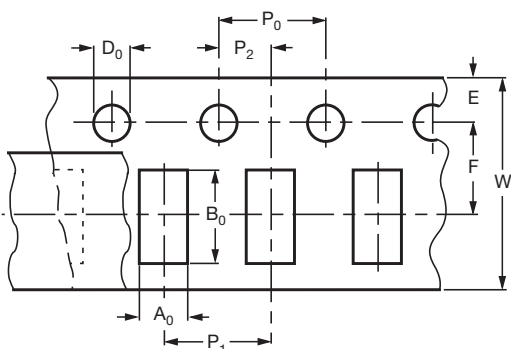

**DIMENSIONS OF PAPER TAPE**

in millimeters

SYM.	PRODUCT SIZE CODE	
	0402	0603
$A_0$	$0.62 \pm 0.05$	$1.02 \pm 0.05$
$B_0$	$1.12 \pm 0.05$	$1.80 \pm 0.05$
W	$8.00 \pm 0.10$	$8.00 \pm 0.10$
E	$1.75 \pm 0.05$	$1.75 \pm 0.05$
F	$3.50 \pm 0.05$	$3.50 \pm 0.05$
$D_0$	$1.55 \pm 0.05$	$1.55 \pm 0.05$
$P_0$	$4.00 \pm 0.10$	$4.00 \pm 0.10$
$P_1$	$2.00 \pm 0.05$	$4.00 \pm 0.10$
$P_2$	$2.00 \pm 0.05$	$2.00 \pm 0.05$

**REEL SPECIFICATIONS**

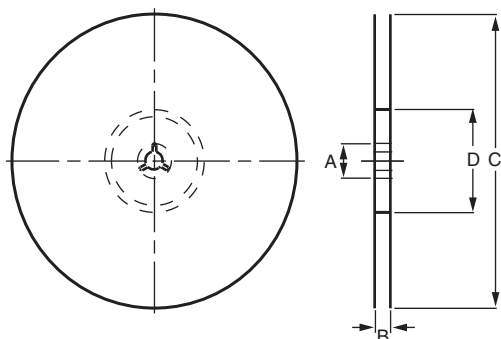

**REEL DIMENSIONS AND TAPE WIDTH**

in millimeters

	$\varnothing 180 \text{ mm}; 7''$	$\varnothing 330 \text{ mm}; 13''$
A	$13.0 \pm 0.5$	$13.0 \pm 0.5$
B	$9.0 \pm 1.0$	$9.0 \pm 1.0$
C	$178.0 \pm 1.0$	$330.0 \pm 1.0$
D	$60.0 \pm 1.0$	$100.0 \pm 1.0$



**TYPICAL ELECTRICAL CHARACTERISTICS**

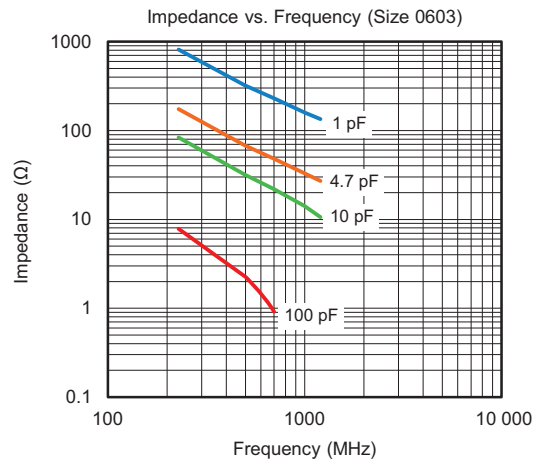
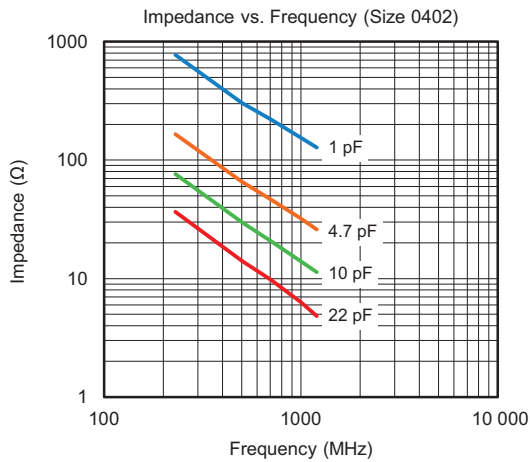
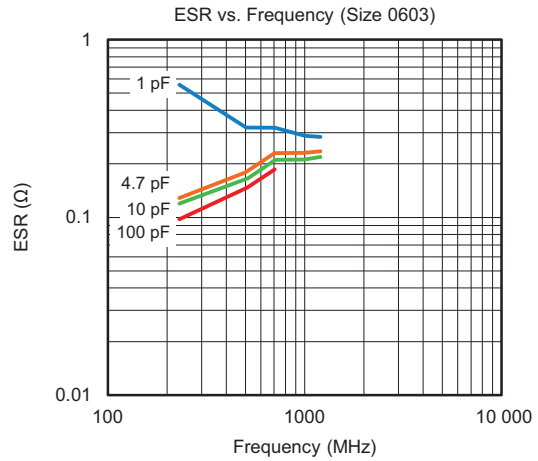
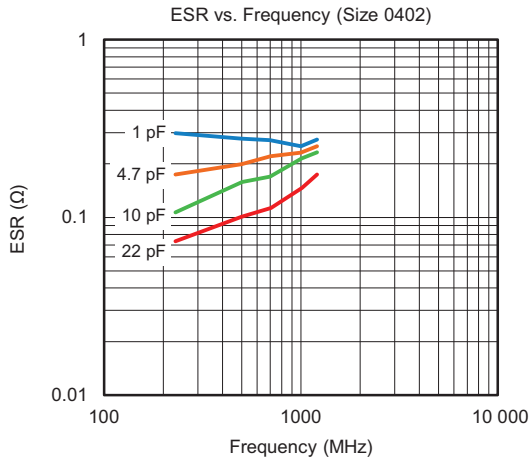
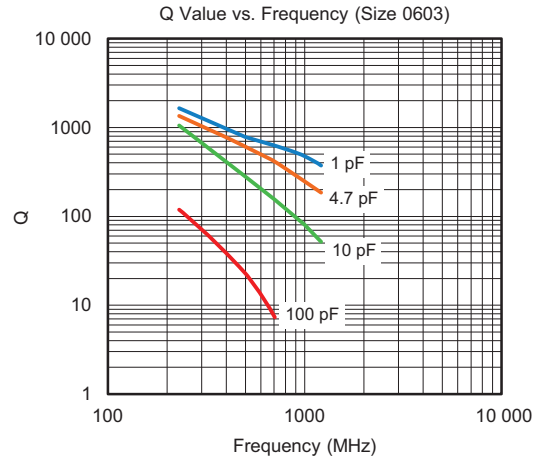
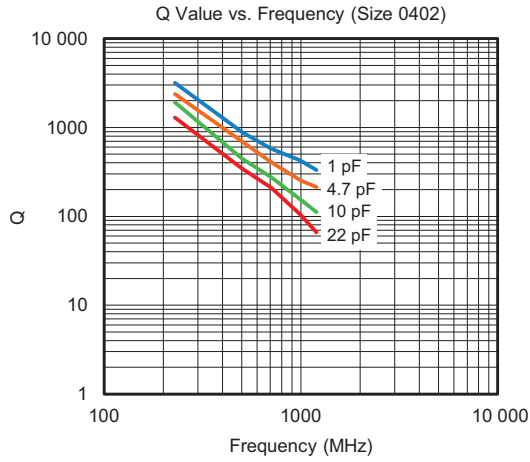



**TYPICAL ELECTRICAL CHARACTERISTICS**

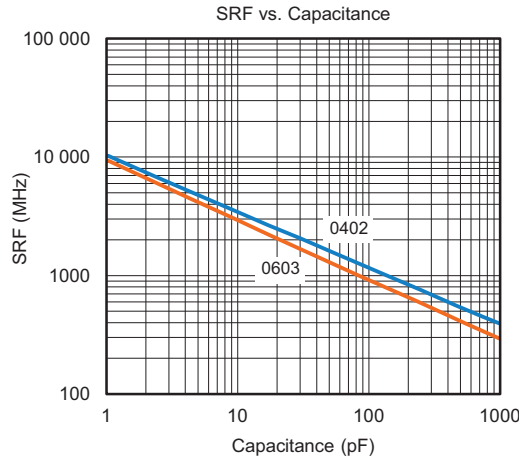

**CONSTRUCTION**

NO.	NAME	HIGH Q
1	Ceramic material	CaZrO <sub>3</sub> based
2	Inner electrode	Ni
3	Termination	Inner layer
4		Middle layer
5		Outer layer
		Sn (matt)

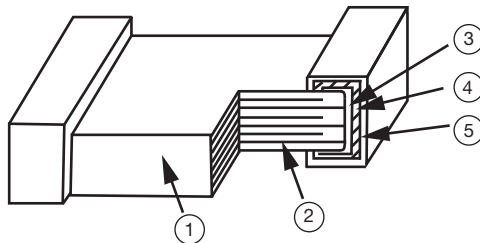

**STORAGE AND HANDLING CONDITIONS**

- (1) To store products at 5 °C to 40 °C ambient temperature and 20 % to 70 % related humidity conditions.
- (2) The product is recommended to be used within one year after shipment. Check solderability in case of shelf life extension is needed.

Cautions:

- a. Do not store products in a corrosive environment such as sulfide, chloride gas, or acid. It may cause oxidization of electrode, which easily be resulted in poor soldering.
- b. To store products on the shelf and avoid exposure to moisture.
- c. Do not expose products to excessive shock, vibration, direct sunlight and so on.



## Disclaimer

ALL PRODUCT, PRODUCT SPECIFICATIONS AND DATA ARE SUBJECT TO CHANGE WITHOUT NOTICE TO IMPROVE RELIABILITY, FUNCTION OR DESIGN OR OTHERWISE.

Vishay Intertechnology, Inc., its affiliates, agents, and employees, and all persons acting on its or their behalf (collectively, "Vishay"), disclaim any and all liability for any errors, inaccuracies or incompleteness contained in any datasheet or in any other disclosure relating to any product.

Vishay makes no warranty, representation or guarantee regarding the suitability of the products for any particular purpose or the continuing production of any product. To the maximum extent permitted by applicable law, Vishay disclaims (i) any and all liability arising out of the application or use of any product, (ii) any and all liability, including without limitation special, consequential or incidental damages, and (iii) any and all implied warranties, including warranties of fitness for particular purpose, non-infringement and merchantability.

Statements regarding the suitability of products for certain types of applications are based on Vishay's knowledge of typical requirements that are often placed on Vishay products in generic applications. Such statements are not binding statements about the suitability of products for a particular application. It is the customer's responsibility to validate that a particular product with the properties described in the product specification is suitable for use in a particular application. Parameters provided in datasheets and / or specifications may vary in different applications and performance may vary over time. All operating parameters, including typical parameters, must be validated for each customer application by the customer's technical experts. Product specifications do not expand or otherwise modify Vishay's terms and conditions of purchase, including but not limited to the warranty expressed therein.

Hyperlinks included in this datasheet may direct users to third-party websites. These links are provided as a convenience and for informational purposes only. Inclusion of these hyperlinks does not constitute an endorsement or an approval by Vishay of any of the products, services or opinions of the corporation, organization or individual associated with the third-party website. Vishay disclaims any and all liability and bears no responsibility for the accuracy, legality or content of the third-party website or for that of subsequent links.

Except as expressly indicated in writing, Vishay products are not designed for use in medical, life-saving, or life-sustaining applications or for any other application in which the failure of the Vishay product could result in personal injury or death. Customers using or selling Vishay products not expressly indicated for use in such applications do so at their own risk. Please contact authorized Vishay personnel to obtain written terms and conditions regarding products designed for such applications.

No license, express or implied, by estoppel or otherwise, to any intellectual property rights is granted by this document or by any conduct of Vishay. Product names and markings noted herein may be trademarks of their respective owners.