

## Power SMD LED in PLCC-2 Package

### Description

The TLM.33.. series is an advanced modification of the Vishay TLM.31.. series. It is designed to incorporate larger chips, therefore, capable of withstanding a 50 mA drive current.

The package of the TLM.33.. is the PLCC-2 (equivalent to a size B tantalum capacitor).

It consists of a lead frame which is embedded in a white thermoplast. The reflector inside this package is filled up with clear epoxy.

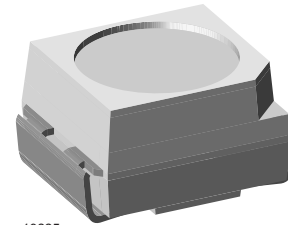

19225



### Features

- Utilizing (AS) AllnGaP technology
- Available in 8 mm tape
- Luminous intensity, color and forward voltage categorized per packing unit
- Luminous intensity ratio per packing unit  
 $I_{Vmax}/I_{Vmin} \leq 1.6$
- Thermal resistance  $R = 400 \text{ K/W}$
- ESD class 2
- Suitable for all soldering methods according to CECC
- Lead-free device

### Applications

Traffic Signals and Signs  
 Interior and exterior lighting  
 Dashboard illumination  
 Indicator and backlighting purposes for audio, video, LCD's switches, symbols, illuminated advertising etc.

### Parts Table

Part	Color, Luminous Intensity	Angle of Half Intensity ( $\pm\phi$ )	Technology
TLMK3300	Red, $I_V > 200 \text{ mcd}$	60 °	AllnGaP on GaAs
TLMK3301	Red, $I_V = (250 \text{ to } 800) \text{ mcd}$	60 °	AllnGaP on GaAs
TLMK3302	Red, $I_V = (400 \text{ to } 800) \text{ mcd}$	60 °	AllnGaP on GaAs
TLMK3303	Red, $I_V = (400 \text{ to } 1250) \text{ mcd}$	60 °	AllnGaP on GaAs
TLMS3300	Red, $I_V > 160 \text{ mcd}$	60 °	AllnGaP on GaAs
TLMS3301	Red, $I_V = (160 \text{ to } 400) \text{ mcd}$	60 °	AllnGaP on GaAs
TLMS3302	Red, $I_V = (250 \text{ to } 800) \text{ mcd}$	60 °	AllnGaP on GaAs
TLMO3300	Soft orange, $I_V > 200 \text{ mcd}$	60 °	AllnGaP on GaAs
TLMO3301	Soft orange, $I_V = (250 \text{ to } 640) \text{ mcd}$	60 °	AllnGaP on GaAs
TLMO3302	Soft orange, $I_V = (320 \text{ to } 800) \text{ mcd}$	60 °	AllnGaP on GaAs

Part	Color, Luminous Intensity	Angle of Half Intensity ( $\pm\phi$ )	Technology
TLMO3303	Soft orange, $I_V = (400 \text{ to } 1250) \text{ mcd}$	60 °	AllnGaP on GaAs
TLMY3300	Yellow, $I_V > 200 \text{ mcd}$	60 °	AllnGaP on GaAs
TLMY3301	Yellow, $I_V = (250 \text{ to } 640) \text{ mcd}$	60 °	AllnGaP on GaAs
TLMY3302	Yellow, $I_V = (320 \text{ to } 800) \text{ mcd}$	60 °	AllnGaP on GaAs
TLMY3303	Yellow, $I_V = (400 \text{ to } 1250) \text{ mcd}$	60 °	AllnGaP on GaAs

### Absolute Maximum Ratings

$T_{amb} = 25 \text{ }^\circ\text{C}$ , unless otherwise specified

TLMY33.., TLMO33.., TLMK33.., TLMS33..

Parameter	Test condition	Symbol	Value	Unit
Reverse voltage		$V_R$	5	V
DC Forward current	$T_{amb} \leq 73 \text{ }^\circ\text{C}$ (400 K/W)	$I_F$	50	mA
Power dissipation	$T_{amb} \leq 73 \text{ }^\circ\text{C}$ (400 K/W)	$P_V$	130	mW
Junction temperature		$T_J$	125	$^\circ\text{C}$
Operating temperature range		$T_{amb}$	- 40 to + 100	$^\circ\text{C}$
Storage temperature range		$T_{stg}$	- 40 to + 100	$^\circ\text{C}$
Soldering temperature	$t \leq 5 \text{ s}$	$T_{sd}$	260	$^\circ\text{C}$
Thermal resistance junction/ambient	mounted on PC board (pad size > 16 mm <sup>2</sup> )	$R_{thJA}$	400	K/W

### Optical and Electrical Characteristics

$T_{amb} = 25 \text{ }^\circ\text{C}$ , unless otherwise specified

#### Red

TLMK33..

Parameter	Test condition	Part	Symbol	Min	Typ.	Max	Unit
Luminous intensity	$I_F = 50 \text{ mA}$	TLMK3300	$I_V$	200	500		mcd
		TLMK3301	$I_V$	250		800	mcd
		TLMK3302	$I_V$	400		800	mcd
		TLMK3303	$I_V$	400		1250	mcd
Luminous flux/Luminous intensity			$\phi_V/I_V$		3		mlm/ mcd
Dominant wavelength	$I_F = 50 \text{ mA}$		$\lambda_d$	611	617	622	nm
Peak wavelength	$I_F = 50 \text{ mA}$		$\lambda_p$		624		nm
Spectral bandwidth at 50 % $I_{rel \text{ max}}$	$I_F = 50 \text{ mA}$		$\Delta\lambda$		18		nm
Angle of half intensity	$I_F = 50 \text{ mA}$		$\phi$		$\pm 60$		deg
Forward voltage	$I_F = 50 \text{ mA}$		$V_F$	1.85	2.1	2.55	V
Reverse current	$V_R = 5 \text{ V}$		$V_R$		0.01	10	$\mu\text{A}$



### Red

#### TLMS33..

Parameter	Test condition	Part	Symbol	Min	Typ.	Max	Unit
Luminous intensity	$I_F = 50 \text{ mA}$	TLMS3300	$I_V$	160	300		mcd
		TLMS3301	$I_V$	160		400	mcd
		TLMS3302	$I_V$	250		800	mcd
Luminous flux/Luminous intensity			$\phi_V/I_V$	3		mlm/mcd	
Dominant wavelength	$I_F = 50 \text{ mA}$		$\lambda_d$	626	630	638	nm
Peak wavelength	$I_F = 50 \text{ mA}$		$\lambda_p$		641		nm
Spectral bandwidth at 50 % $I_{rel \text{ max}}$	$I_F = 50 \text{ mA}$		$\Delta\lambda$		17		nm
Angle of half intensity	$I_F = 50 \text{ mA}$		$\varphi$		$\pm 60$		deg
Forward voltage	$I_F = 50 \text{ mA}$		$V_F$	1.85	2.1	2.55	V
Reverse current	$V_R = 5 \text{ V}$		$V_R$		0.01	10	$\mu\text{A}$

### Soft Orange

#### TLMO33..

Parameter	Test condition	Part	Symbol	Min	Typ.	Max	Unit
Luminous intensity	$I_F = 50 \text{ mA}$	TLMO3300	$I_V$	200	500		mcd
		TLMO3301	$I_V$	250		640	mcd
		TLMO3302	$I_V$	320		800	mcd
		TLMO3303	$I_V$	400		1250	mcd
Luminous flux/Luminous intensity			$\phi_V/I_V$	3		mlm/mcd	
Dominant wavelength	$I_F = 50 \text{ mA}$		$\lambda_d$	600	605	611	nm
Peak wavelength	$I_F = 50 \text{ mA}$		$\lambda_p$		611		nm
Spectral bandwidth at 50 % $I_{rel \text{ max}}$	$I_F = 50 \text{ mA}$		$\Delta\lambda$		17		nm
Angle of half intensity	$I_F = 50 \text{ mA}$		$\varphi$		$\pm 60$		deg
Forward voltage	$I_F = 50 \text{ mA}$		$V_F$	1.85	2.1	2.55	V
Reverse current	$V_R = 5 \text{ V}$		$V_R$		0.01	10	$\mu\text{A}$

### Yellow

#### TLMY33..

Parameter	Test condition	Part	Symbol	Min	Typ.	Max	Unit
Luminous intensity	$I_F = 50 \text{ mA}$	TLMY3300	$I_V$	200	450		mcd
		TLMY3301	$I_V$	250		640	mcd
		TLMY3302	$I_V$	320		800	mcd
		TLMY3303	$I_V$	400		1250	mcd
Luminous flux/Luminous intensity			$\phi_V/I_V$		3		mlm/ mcd
Dominant wavelength	$I_F = 50 \text{ mA}$		$\lambda_d$	583	588	594	nm
Peak wavelength	$I_F = 50 \text{ mA}$		$\lambda_p$		590		nm
Spectral bandwidth at 50 % $I_{rel \text{ max}}$	$I_F = 50 \text{ mA}$		$\Delta\lambda$		18		nm
Angle of half intensity	$I_F = 50 \text{ mA}$		$\phi$		$\pm 60$		deg
Forward voltage	$I_F = 50 \text{ mA}$		$V_F$	1.85	2.1	2.55	V
Reverse current	$V_R = 5 \text{ V}$		$V_R$		0.01	10	$\mu\text{A}$

### Forward Voltage Classification

Group	Forward Voltage (V)	
	min	max
1	1.85	2.25
2	2.15	2.55

### Color Classification

Group	Dominant Wavelength (nm)					
	Red		Soft Orange		Yellow	
	min	max	min	max	min	max
1	611	618	598	601	581	584
2	614	622	600	603	583	586
3			602	605	585	588
4			604	607	587	590
5			606	609	589	592
6			608	611	591	594

### Luminous Intensity Classification

Group	Luminous Intensity (mcd)	
	min	max
Xa	160	250
Xb	200	320
Ya	250	400
Yb	320	500
Za	400	630
Zb	500	800
0a	630	1000
0b	800	1250

## Group Name on Label

Luminous Intensity Group	Halfgroup	Wavelength	Forward Voltage
Z	b	2	1

One packing unit/tape contains only one classification group of luminous intensity, color and forward voltage

Only one single classification groups is not available

The given groups are not order codes, customer specific group combinations require marketing agreement

No color subgrouping for Super Red

## Typical Characteristics ( $T_{amb} = 25\text{ }^{\circ}\text{C}$ unless otherwise specified)

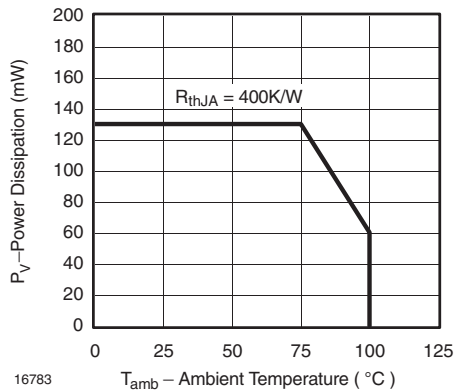

Figure 1. Power Dissipation vs. Ambient Temperature

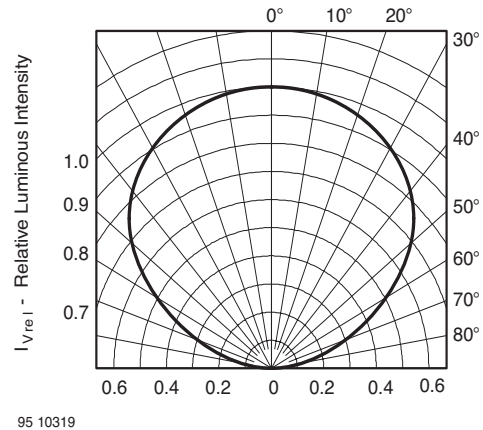

Figure 3. Rel. Luminous Intensity vs. Angular Displacement

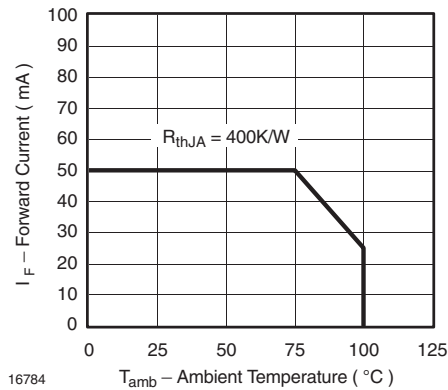

Figure 2. Forward Current vs. Ambient Temperature

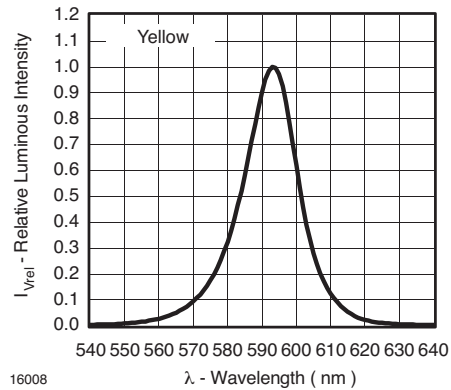

Figure 4. Relative Intensity vs. Wavelength

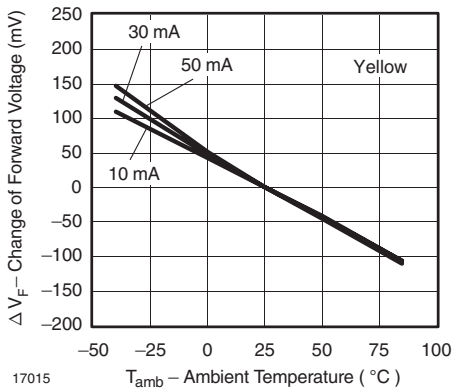

Figure 5. Change of Forward Voltage vs. Ambient Temperature

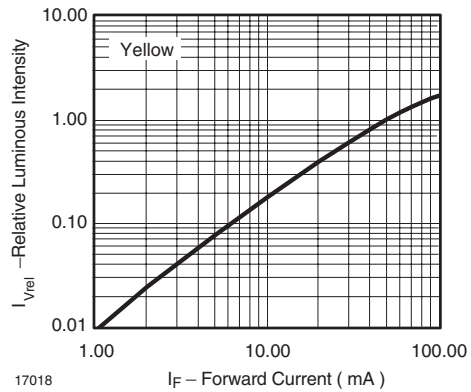

Figure 8. Relative Luminous Intensity vs. Forward Current

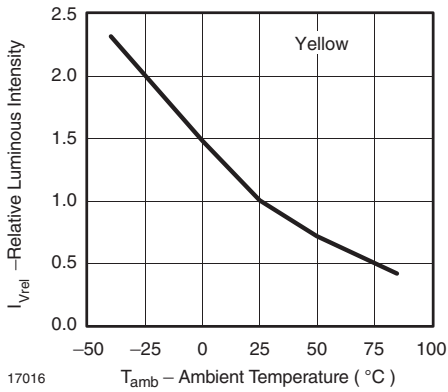

Figure 6. Relative Luminous Intensity vs. Amb. Temperature

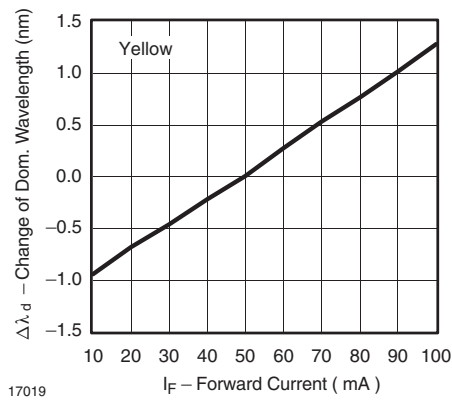

Figure 9. Change of Dominant Wavelength vs. Forward Current

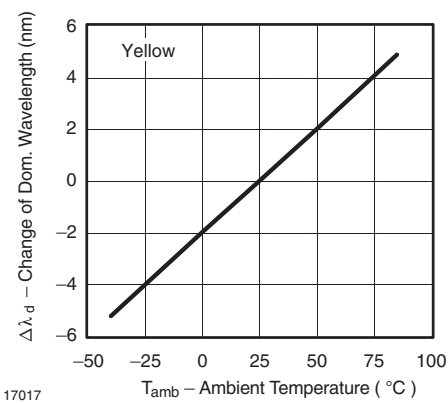

Figure 7. Change of Dominant Wavelength vs. Ambient Temperature

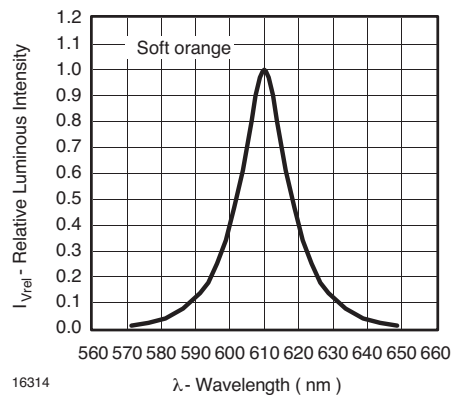

Figure 10. Relative Intensity vs. Wavelength

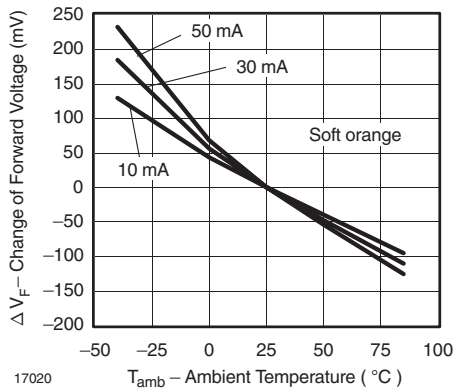

Figure 11. Change of Forward Voltage vs. Ambient Temperature

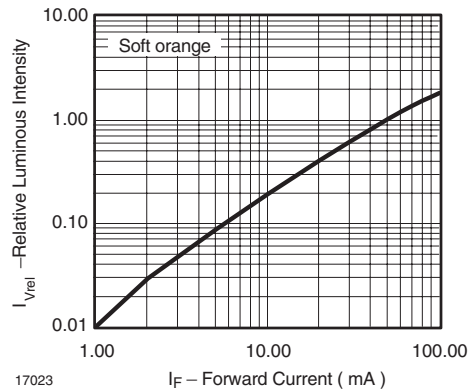

Figure 14. Relative Luminous Intensity vs. Forward Current

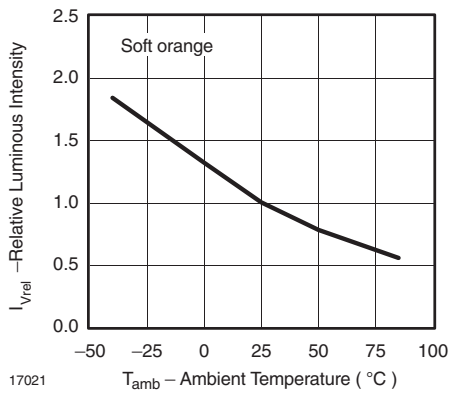

Figure 12. Relative Luminous Intensity vs. Amb. Temperature

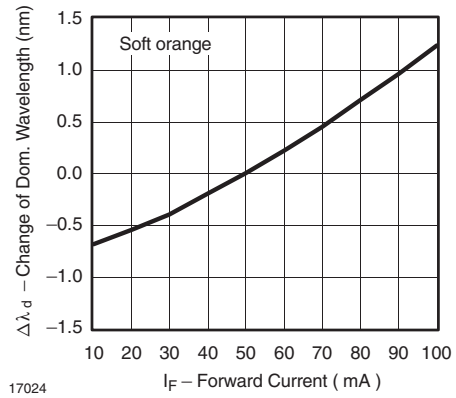

Figure 15. Change of Dominant Wavelength vs. Forward Current

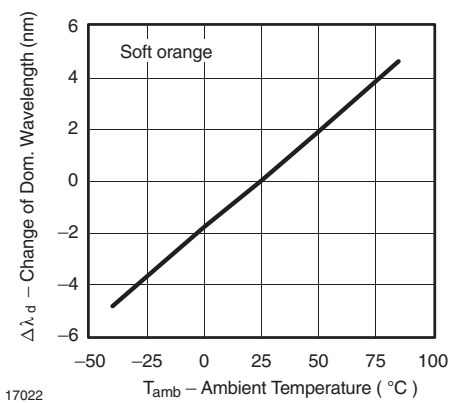

Figure 13. Change of Dominant Wavelength vs. Ambient Temperature

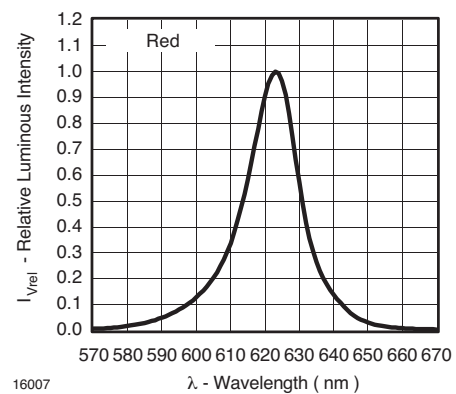

Figure 16. Relative Intensity vs. Wavelength

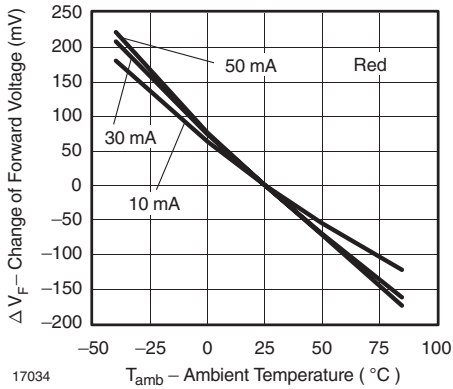

Figure 17. Change of Forward Voltage vs. Ambient Temperature

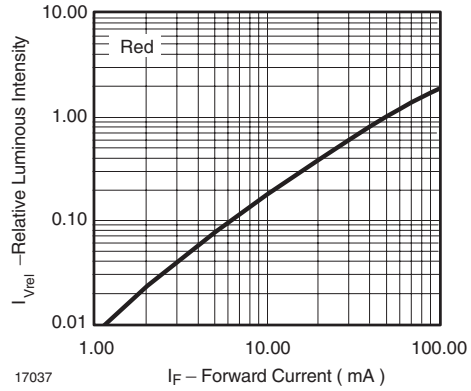

Figure 20. Relative Luminous Intensity vs. Forward Current

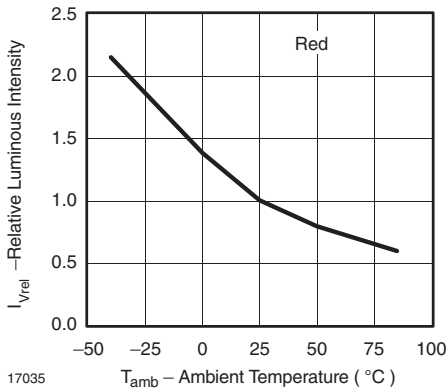

Figure 18. Relative Luminous Intensity vs. Amb. Temperature

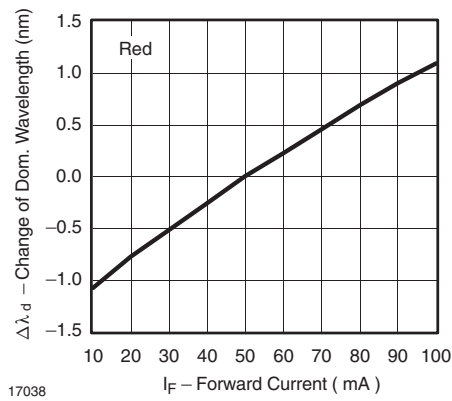

Figure 21. Change of Dominant Wavelength vs. Forward Current

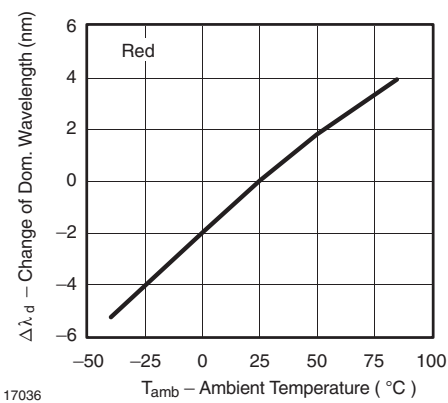

Figure 19. Change of Dominant Wavelength vs. Ambient Temperature

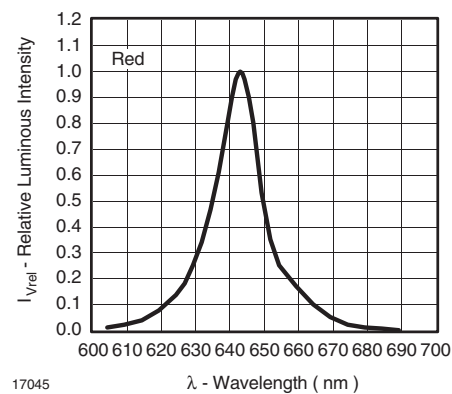

Figure 22. Relative Intensity vs. Wavelength



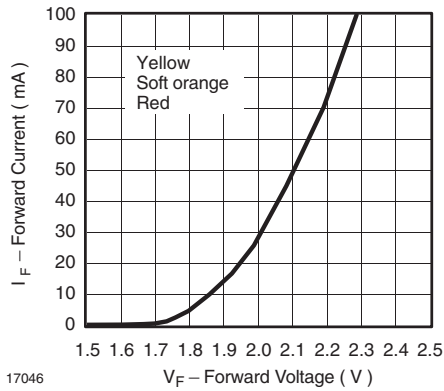

Figure 23. Forward Current vs. Forward Voltage

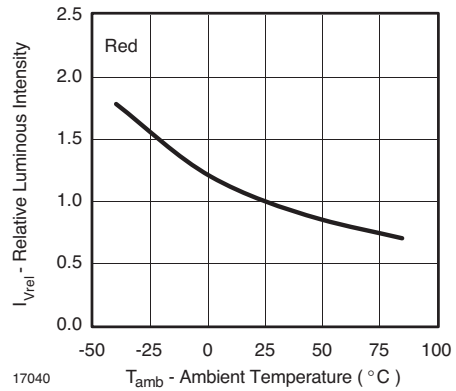

Figure 26. Relative Luminous Intensity vs. Amb. Temperature

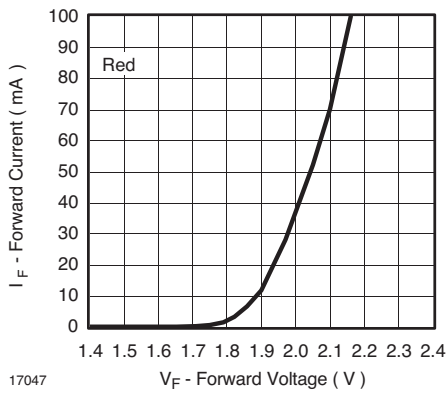

Figure 24. Forward Current vs. Forward Voltage

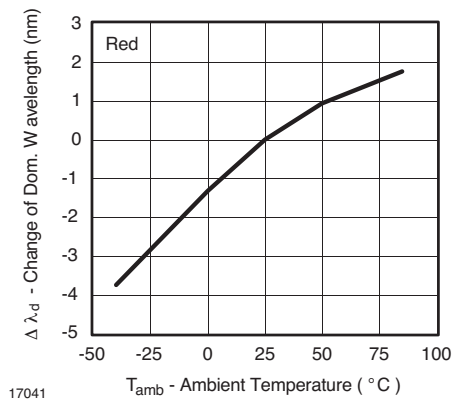

Figure 27. Change of Dominant Wavelength vs. Ambient Temperature

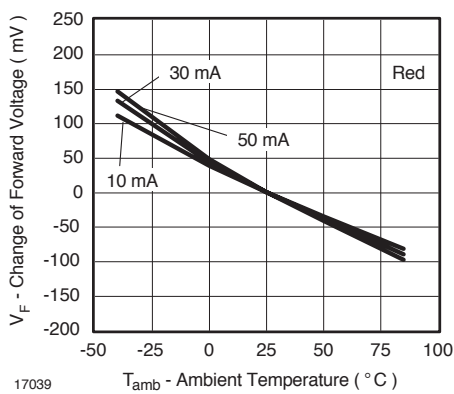

Figure 25. Change of Forward Voltage vs. Ambient Temperature

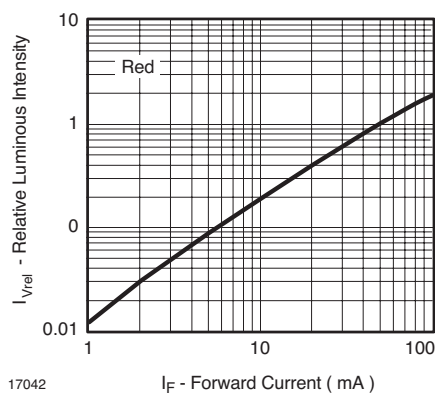

Figure 28. Relative Luminous Intensity vs. Forward Current

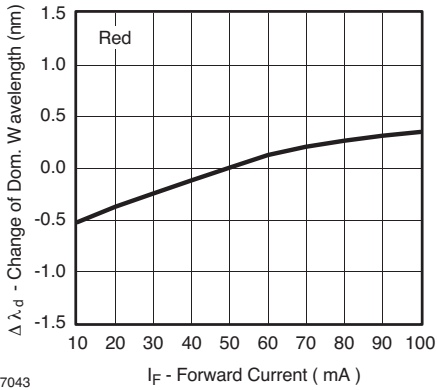

Figure 29. Change of Dominant Wavelength vs. Forward Current

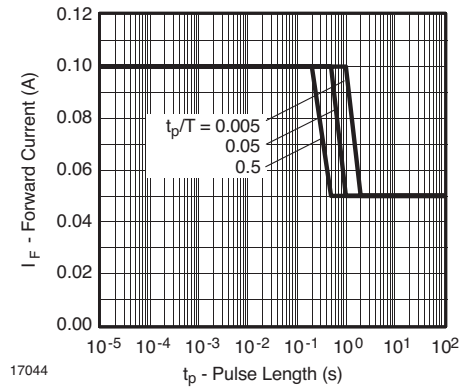
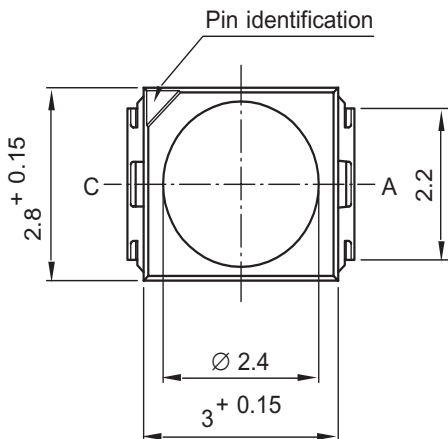
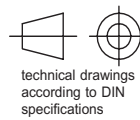
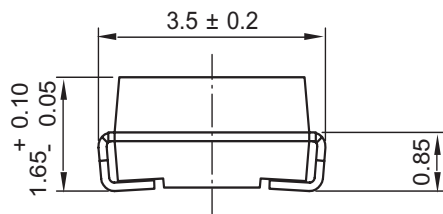
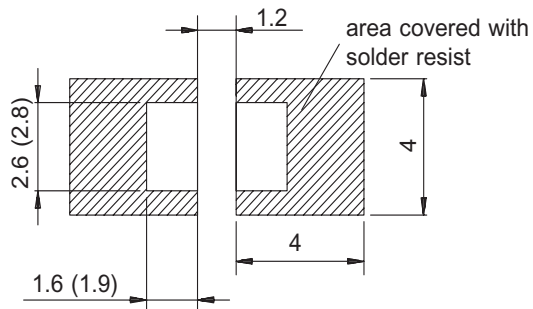

Figure 30. Forward Current vs. Pulse Length

## Package Dimensions in mm



### Mounting Pad Layout



Dimensions: IR and Vaporphase (Wave Soldering)

Drawing-No. : 6.541-5025.01-4  
Issue: 7; 05.04.04

95 11314



## **Ozone Depleting Substances Policy Statement**

It is the policy of **Vishay Semiconductor GmbH** to

1. Meet all present and future national and international statutory requirements.
2. Regularly and continuously improve the performance of our products, processes, distribution and operating systems with respect to their impact on the health and safety of our employees and the public, as well as their impact on the environment.

It is particular concern to control or eliminate releases of those substances into the atmosphere which are known as ozone depleting substances (ODSs).

The Montreal Protocol (1987) and its London Amendments (1990) intend to severely restrict the use of ODSs and forbid their use within the next ten years. Various national and international initiatives are pressing for an earlier ban on these substances.

**Vishay Semiconductor GmbH** has been able to use its policy of continuous improvements to eliminate the use of ODSs listed in the following documents.

1. Annex A, B and list of transitional substances of the Montreal Protocol and the London Amendments respectively
2. Class I and II ozone depleting substances in the Clean Air Act Amendments of 1990 by the Environmental Protection Agency (EPA) in the USA
3. Council Decision 88/540/EEC and 91/690/EEC Annex A, B and C (transitional substances) respectively.

**Vishay Semiconductor GmbH** can certify that our semiconductors are not manufactured with ozone depleting substances and do not contain such substances.

**We reserve the right to make changes to improve technical design  
and may do so without further notice.**

Parameters can vary in different applications. All operating parameters must be validated for each customer application by the customer. Should the buyer use Vishay Semiconductors products for any unintended or unauthorized application, the buyer shall indemnify Vishay Semiconductors against all claims, costs, damages, and expenses, arising out of, directly or indirectly, any claim of personal damage, injury or death associated with such unintended or unauthorized use.

Vishay Semiconductor GmbH, P.O.B. 3535, D-74025 Heilbronn, Germany  
Telephone: 49 (0)7131 67 2831, Fax number: 49 (0)7131 67 2423



### Notice

Specifications of the products displayed herein are subject to change without notice. Vishay Intertechnology, Inc., or anyone on its behalf, assumes no responsibility or liability for any errors or inaccuracies.

Information contained herein is intended to provide a product description only. No license, express or implied, by estoppel or otherwise, to any intellectual property rights is granted by this document. Except as provided in Vishay's terms and conditions of sale for such products, Vishay assumes no liability whatsoever, and disclaims any express or implied warranty, relating to sale and/or use of Vishay products including liability or warranties relating to fitness for a particular purpose, merchantability, or infringement of any patent, copyright, or other intellectual property right.

The products shown herein are not designed for use in medical, life-saving, or life-sustaining applications. Customers using or selling these products for use in such applications do so at their own risk and agree to fully indemnify Vishay for any damages resulting from such improper use or sale.