

Preamplifier Circuit for IR Remote Control

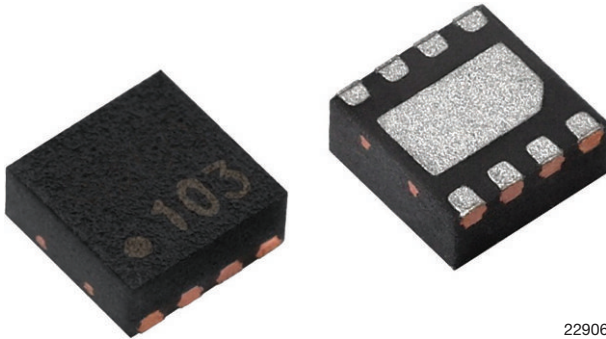

22906

LINKS TO ADDITIONAL RESOURCES



DESCRIPTION

The VSOP98260 is designed for use in an IR learning application together with a photo PIN diode or IR LED as optical detector. It is compatible with all data formats for IR remote control. On the other hand it is immune to current caused by light sources such as tungsten bulbs or fluorescent lamps.

ESD

- To maximize the sensitivity, the TIA input pin has minimal ESD protection. Care should be taken never to touch or otherwise expose this pin to an adverse ESD source. The ESD protection conforms to Class 1B

FEATURES

- Carrier-out-function: carrier frequency and burst length accurately correspond to the input signal
- AC coupled response from 20 kHz to 60 kHz; all data formats
- Small QFN package with 2 mm width
- Can be used with either a photodiode or an IR emitter in forward or reverse polarity
- AC coupled input is insensitive to DC photocurrents
- Material categorization: for definitions of compliance please see www.vishay.com/doc?99912

RoHS
COMPLIANT
HALOGEN
FREE
GREEN
(5-2008)

MECHANICAL DATA

Pinning:

1, 4, 5= N.C., 2 = V_S , 3 = OUT, 6, 8 = GND, 7 = IN

ORDERING CODE

VSOP.... - 3000 pieces in tape and reel

BLOCK DIAGRAM (simplified)

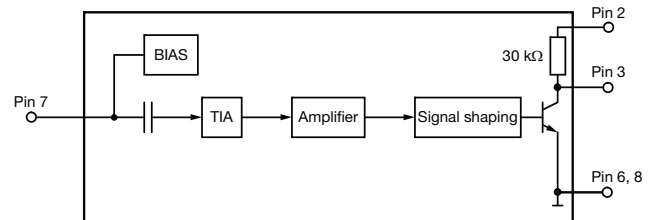

APPLICATION CIRCUIT

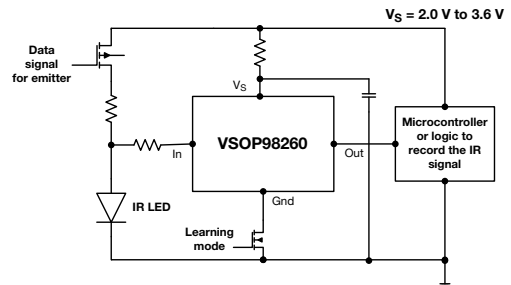

Recommended to minimize the connection distance between the IR LED and the input of the VSOP98260, and if possible to shield this connection to Gnd.

Note

- For further information, see application note, "IC for Code Learning Applications"

PARTS TABLE		
Carrier frequency	38 kHz	VSOP98260
Package		VSOP
Pinning		1, 4, 5 = N.C., 2 = V_S , 3 = OUT, 6, 8 = GND, 7 = IN
Dimensions (mm)		2.0 W x 2.0 H x 0.76 D
Mounting		SMD
Application		Code learning

ABSOLUTE MAXIMUM RATINGS ($T_{amb} = 25\text{ }^{\circ}\text{C}$, unless otherwise specified)				
PARAMETER	TEST CONDITION	SYMBOL	VALUE	UNIT
Supply voltage	Pin 2	V_S	-0.3 to +6	V
Supply current	Pin 2	I_S	5	mA
Output voltage	Pin 3	V_O	-0.3 to ($V_S + 0.3$)	V
Output current	Pin 3	I_O	5	mA
Input voltage	Pin 7	V_I	-0.3 to 3.3	V
Input current	Pin 7	I_I	7	mA
Power dissipation	$T_{amb} \leq 85\text{ }^{\circ}\text{C}$	P_{tot}	10	mW
Operating temperature range		T_{amb}	-25 to +85	$^{\circ}\text{C}$
Storage temperature range		T_{stg}	-25 to +85	$^{\circ}\text{C}$
ESD stress, HBM	Pin 2, pin 3, MIL-STD-883C	V_{ESD}	2000	V
	Pin 7, MIL-STD-883C	V_{ESD}	500	V
ESD stress, MM	Pin 2, pin 3, MIL-STD-883C	V_{ESD}	200	V
	Pin 7, MIL-STD-883C	V_{ESD}	100	V

Note

- Stresses beyond those listed under "Absolute Maximum Ratings" may cause permanent damage to the device. This is a stress rating only and functional operation of the device at these or any other conditions beyond those indicated in the operational sections of this specification is not implied. Exposure to absolute maximum rating conditions for extended periods may affect the device reliability

ELECTRICAL CHARACTERISTICS ($T_{amb} = 5\text{ }^{\circ}\text{C}$ to $+85\text{ }^{\circ}\text{C}$, unless otherwise specified)						
PARAMETER	TEST CONDITION	SYMBOL	MIN.	TYP.	MAX.	UNIT
Supply voltage		V_S	2.0	-	3.6	V
Supply current (pin 2)	$I_{IN-DC} = 0, V_S = 5\text{ V}$	I_S	0.55	0.7	0.9	mA
Output voltage low (pin 3)	$I_{OL} = 2\text{ mA}$	V_{OL}	-	-	100	mV
Output voltage high (pin 3)	$I_{OL} = 0$	V_{OH}	$V_S - 0.25$	-	-	V
Internal pull up resistor (pin 2, pin 3)		R_{PU}	-	33	-	$k\Omega$
Max. input DC current	$V_{IN} > 0$	$I_{IN-DCmax.}$	400	-	-	μA
Min. signal detection current	$I_{IN-DC} = 0, f_C = f_{BPF}$	$I_{IN-min.}$	-	40	80	nA
	$I_{IN-DC} = 100\text{ }\mu\text{A}, f_C = f_{BPF}$	$I_{IN-min.}$	-	50	-	nA
Output accuracy	$f_C = 20\text{ kHz to }60\text{ kHz}$, $I_{IN} = 80\text{ nA to }50\text{ }\mu\text{A}$, testsignal see fig. 1, BER $\leq 2\%$	N carrier pulses	input burst length -1 cycle	input burst length	input burst length +1 cycle	counts

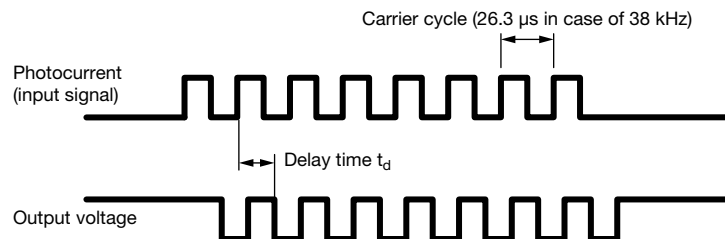
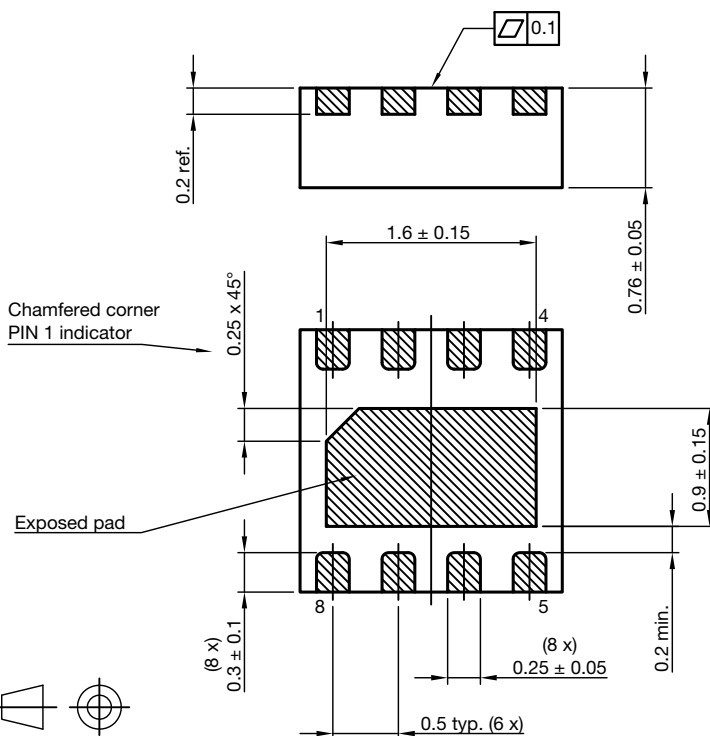
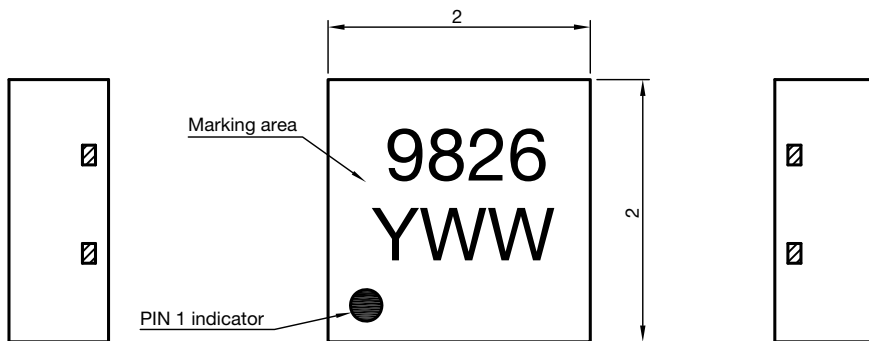

Fig. 1 - Testsignal

PACKAGE DIMENSIONS in millimeters



1. Coplanarity (0.1 mm) applies to the exposed pad as well as the exposed terminals.
2. Package dimension does not include mold flash, protrusions, burrs or metal smearing.

Pinning:

1. n.c.
2. V_S
3. Out Both pin 6 and pin 8 must be grounded.
4. n.c. The exposed pad may also be grounded, but this is optional.
5. n.c.
6. GND
7. IN
8. GND

Proposed hole layout from component side (for reference only)

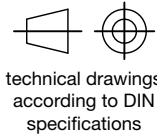
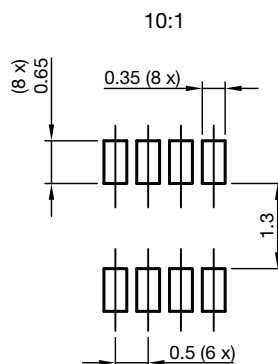

technical drawings according to DIN specifications

Not indicated tolerances ± 0.1

Drawing-No.: 6.550-5314.04-4
Issue: -; 13.05.16



ASSEMBLY INSTRUCTIONS

Reflow Soldering

- Set the furnace temperatures for pre-heating and heating in accordance with the reflow temperature profile as shown in the diagram. Exercise extreme care to keep the maximum temperature below 260 °C. The temperature shown in the profile means the temperature at the device surface. Since there is a temperature difference between the component and the circuit board, it should be verified that the temperature of the device is accurately being measured
- Handling after reflow should be done only after the work surface has been cooled off

Manual Soldering

- Use a soldering iron of 25 W or less. Adjust the temperature of the soldering iron below 300 °C
- Finish soldering within 3 s
- Handle products only after the temperature has cooled off

VISHAY LEAD (PB)-FREE REFLOW SOLDER PROFILE

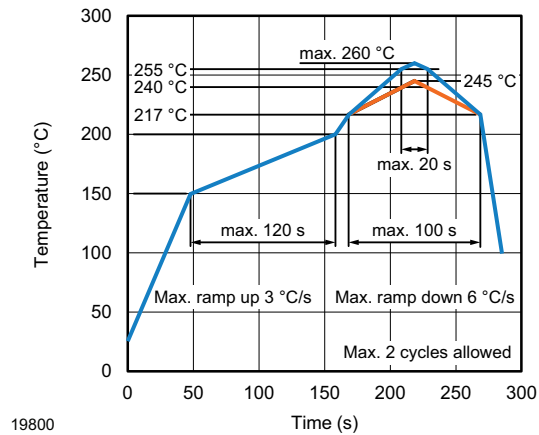

TAPING VERSION VSOP DIMENSIONS in millimeters

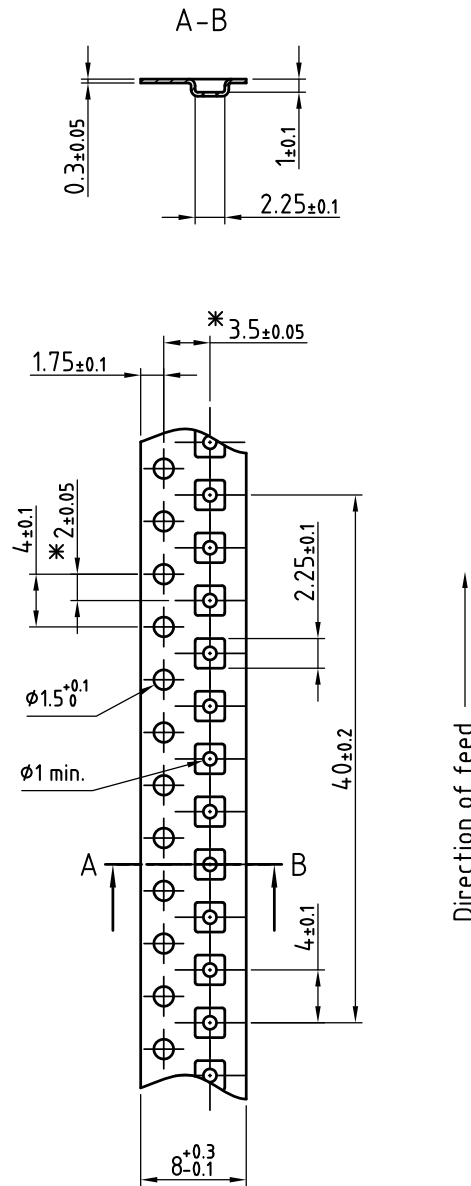

* Measured from centerline of sprocket hole to centerline of pocket

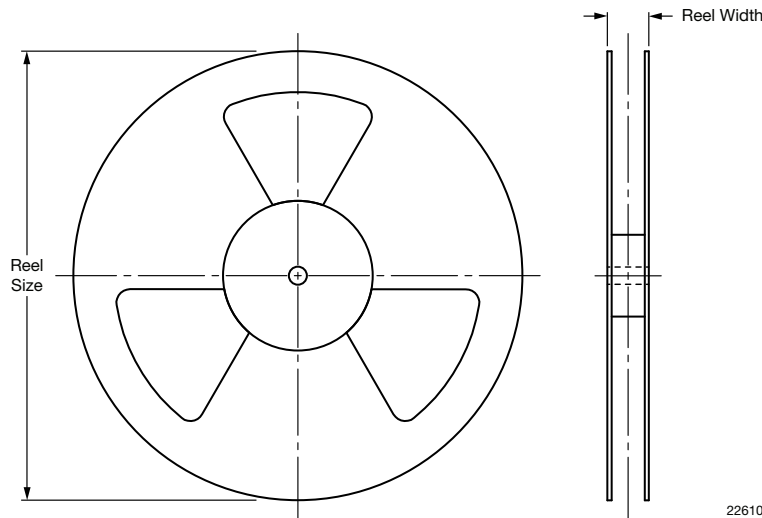
REEL DIMENSIONS in millimeters

22610

REEL		TRAILER LENGTH (mm)	LEADER LENGTH (mm)	QUANTITY PER REEL
REEL SIZE (inch)	REEL WIDTH (mm)			
7	8.4	160	400	3000

LABEL
Standard bar code labels for finished goods

The standard bar code labels are product labels and used for identification of goods. The finished goods are packed in final packing area. The standard packing units are labeled

with standard bar code labels before transported as finished goods to warehouses. The labels are on each packing unit and contain Vishay Semiconductor GmbH specific data.

VISHAY SEMICONDUCTOR GMBH STANDARD BAR CODE PRODUCT LABEL (finished goods)		
PLAIN WRITTING	ABBREVIATION	LENGTH
Item-description	-	18
Item-number	INO	8
Selection-code	SEL	3
LOT-/serial-number	BATCH	10
Data-code	COD	3 (YWW)
Plant-code	PTC	2
Quantity	QTY	8
Accepted by	ACC	-
Packed by	PCK	-
Mixed code indicator	MIXED CODE	-
Origin	xxxxxxx+	Company logo
LONG BAR CODE TOP	TYPE	LENGTH
Item-number	N	8
Plant-code	N	2
Sequence-number	X	3
Quantity	N	8
Total length	-	21
SHORT BAR CODE BOTTOM	TYPE	LENGTH
Selection-code	X	3
Data-code	N	3
Batch-number	X	10
Filter	-	1
Total length	-	17



ESD PRECAUTION

Proper storage and handling procedures should be followed to prevent ESD damage to the devices especially when they are removed from the antistatic shielding bag. Electrostatic sensitive devices warning labels are on the packaging.

VISHAY SEMICONDUCTORS STANDARD BAR CODE LABELS

The Vishay Semiconductors standard bar code labels are printed at final packing areas. The labels are on each packing unit and contain Vishay Semiconductors specific data.



22645



Disclaimer

ALL PRODUCT, PRODUCT SPECIFICATIONS AND DATA ARE SUBJECT TO CHANGE WITHOUT NOTICE TO IMPROVE RELIABILITY, FUNCTION OR DESIGN OR OTHERWISE.

Vishay Intertechnology, Inc., its affiliates, agents, and employees, and all persons acting on its or their behalf (collectively, "Vishay"), disclaim any and all liability for any errors, inaccuracies or incompleteness contained in any datasheet or in any other disclosure relating to any product.

Vishay makes no warranty, representation or guarantee regarding the suitability of the products for any particular purpose or the continuing production of any product. To the maximum extent permitted by applicable law, Vishay disclaims (i) any and all liability arising out of the application or use of any product, (ii) any and all liability, including without limitation special, consequential or incidental damages, and (iii) any and all implied warranties, including warranties of fitness for particular purpose, non-infringement and merchantability.

Statements regarding the suitability of products for certain types of applications are based on Vishay's knowledge of typical requirements that are often placed on Vishay products in generic applications. Such statements are not binding statements about the suitability of products for a particular application. It is the customer's responsibility to validate that a particular product with the properties described in the product specification is suitable for use in a particular application. Parameters provided in datasheets and / or specifications may vary in different applications and performance may vary over time. All operating parameters, including typical parameters, must be validated for each customer application by the customer's technical experts. Product specifications do not expand or otherwise modify Vishay's terms and conditions of purchase, including but not limited to the warranty expressed therein.

Hyperlinks included in this datasheet may direct users to third-party websites. These links are provided as a convenience and for informational purposes only. Inclusion of these hyperlinks does not constitute an endorsement or an approval by Vishay of any of the products, services or opinions of the corporation, organization or individual associated with the third-party website. Vishay disclaims any and all liability and bears no responsibility for the accuracy, legality or content of the third-party website or for that of subsequent links.

Except as expressly indicated in writing, Vishay products are not designed for use in medical, life-saving, or life-sustaining applications or for any other application in which the failure of the Vishay product could result in personal injury or death. Customers using or selling Vishay products not expressly indicated for use in such applications do so at their own risk. Please contact authorized Vishay personnel to obtain written terms and conditions regarding products designed for such applications.

No license, express or implied, by estoppel or otherwise, to any intellectual property rights is granted by this document or by any conduct of Vishay. Product names and markings noted herein may be trademarks of their respective owners.