

Single P-Channel 20 V (D-S) MOSFET With Schottky Diode

PRODUCT SUMMARY		
V _{DS} (V)	R _{DS(on)} (Ω)	I _D (A)
- 20	0.048 at V _{GS} = - 4.5 V	- 6.3
	0.068 at V _{GS} = - 2.5 V	- 5.3
	0.090 at V _{GS} = - 1.8 V	- 4.6

SCHOTTKY PRODUCT SUMMARY		
V _{KA} (V)	V _f (V) Diode Forward Voltage	I _F (A)
20	0.48 V at 0.5 A	1

PowerPAK 1212-8

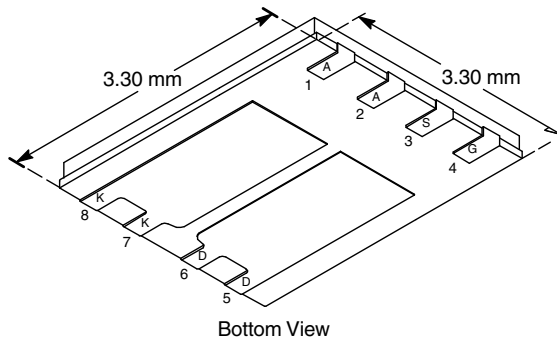

FEATURES

- TrenchFET® Power MOSFETS: 1.8 V Rated
- ESD Protected: 4500 V
- Ultra-Low Thermal Resistance, PowerPAK® Package with Low 1.07 mm Profile
- Material categorization:
For definitions of compliance please see www.vishay.com/doc?99912



RoHS
COMPLIANT
HALOGEN
FREE

APPLICATIONS

- Charger Switching

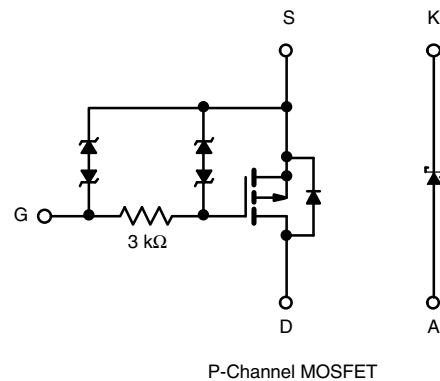

Ordering Information:

Si7703EDN-T1-GE3 (Lead (Pb)-free and Halogen-free)

ABSOLUTE MAXIMUM RATINGS (T _A = 25 °C, unless otherwise noted)				
Parameter	Symbol	10 s	Steady State	Unit
Drain-Source Voltage (MOSFET and Schottky)	V _{DS}	- 20		V
Reverse Voltage (Schottky)	V _{KA}	20		
Gate-Source Voltage (MOSFET)	V _{GS}	± 12	± 12	
Continuous Drain Current (T _J = 150 °C) (MOSFET) ^a	I _D	T _A = 25 °C	- 6.3	- 4.3
		T _A = 85 °C	- 4.5	- 3.1
Pulsed Drain Current (MOSFET)	I _{DM}	- 20		A
Continuous Source Current (MOSFET Diode Conduction) ^a	I _S	- 2.3	- 1.1	
Average Forward Current (Schottky)	I _F	1		
Pulsed Forward Current (Schottky)	I _{FM}	7		
Maximum Power Dissipation (MOSFET) ^a	P _D	T _A = 25 °C	2.8	1.3
		T _A = 85 °C	1.5	0.7
Maximum Power Dissipation (Schottky) ^a	P _D	T _A = 25 °C	2	1.1
		T _A = 85 °C	1	0.6
Operating Junction and Storage Temperature Range	T _J , T _{stg}	- 55 to 150		°C
Soldering Recommendations ^{b,c}		260		

Notes:

- Surface mounted on 1" x 1" FR4 board.
- See solder profile (www.vishay.com/doc?73257). The PowerPAK 1212-8 is a leadless package. The end of the lead terminal is exposed copper (not plated) as a result of the singulation process in manufacturing. A solder fillet at the exposed copper tip cannot be guaranteed and is not required to ensure adequate bottom side solder interconnection.
- Rework conditions: manual soldering with a soldering iron is not recommended for leadless components.

THERMAL RESISTANCE RATINGS						
Parameter		Device	Symbol	Typical	Maximum	Unit
Junction-to-Ambient ^a	t ≤ 10 s	MOSFET	R _{thJA}	35	44	°C/W
		Schottky		51	64	
	Steady State	MOSFET		75	94	
		Schottky		91	115	
Junction-to-Case (Drain)	Steady State	MOSFET	R _{thJC}	4	5	
		Schottky	10	12		

Notes

a. Surface Mounted on 1" x 1" FR4 board.

MOSFET SPECIFICATIONS (T _J = 25 °C, unless otherwise noted)						
Parameter	Symbol	Test Conditions	Min.	Typ.	Max.	Unit
Static						
Gate Threshold Voltage	V _{GS(th)}	V _{DS} = V _{GS} , I _D = - 800 μA	- 0.45		- 1	V
Gate-Body Leakage	I _{GSS}	V _{DS} = 0 V, V _{GS} = ± 4.5 V			± 1.5	μA
		V _{DS} = 0 V, V _{GS} = ± 12 V			± 100	mA
Zero Gate Voltage Drain Current	I _{DSS}	V _{DS} = - 20 V, V _{GS} = 0 V			- 1	μA
		V _{DS} = - 20 V, V _{GS} = 0 V, T _J = 85 °C			- 5	
On-State Drain Current ^a	I _{D(on)}	V _{DS} ≤ - 5 V, V _{GS} = - 4.5 V	- 20			A
Drain-Source On-State Resistance ^a	R _{DS(on)}	V _{GS} = - 4.5 V, I _D = - 6.3 A		0.041	0.048	Ω
		V _{GS} = - 2.5 V, I _D = - 5.3 A		0.057	0.068	
		V _{GS} = - 1.8 V, I _D = - 1 A		0.072	0.090	
Forward Transconductance ^a	g _{fs}	V _{DS} = - 10 V, I _D = - 6.3 A		14		S
Diode Forward Voltage ^a	V _{SD}	I _S = - 2.3 A, V _{GS} = 0 V		- 0.8	- 1.2	V
Dynamic^b						
Total Gate Charge	Q _g	V _{DS} = - 10 V, V _{GS} = - 4.5 V, I _D = - 6.3 A		12	18	nC
Gate-Source Charge	Q _{gs}		2.5			
Gate-Drain Charge	Q _{gd}		2.9			
Turn-On Delay Time	t _{d(on)}	V _{DD} = - 10 V, R _L = 10 Ω I _D ≅ - 1 A, V _{GEN} = - 4.5 V, R _G = 6 Ω		2.5	4	vs
Rise Time	t _r		4	6		
Turn-Off Delay Time	t _{d(off)}		15	23		
Fall Time	t _f		12	18		

Notes

a. Pulse test; pulse width ≤ 300 μs, duty cycle ≤ 2 %.

b. Guaranteed by design, not subject to production testing.

SCHOTTKY SPECIFICATIONS (T _J = 25 °C, unless otherwise noted)						
Parameter	Symbol	Test Conditions	Min.	Typ.	Max.	Unit
Forward Voltage Drop	V _F	I _F = 0.5 A		0.42	0.48	V
		I _F = 0.5 A, T _J = 125 °C		0.33	0.4	
Maximum Reverse Leakage Current	I _{rm}	V _r = 20 V		0.002	0.100	mA
		V _r = 20 V, T _J = 85 °C		0.10	1	
		V _r = 20 V, T _J = 125 °C		1.5	10	
Junction Capacitance	C _T	V _r = 10 V		31		pF

Stresses beyond those listed under "Absolute Maximum Ratings" may cause permanent damage to the device. These are stress ratings only, and functional operation of the device at these or any other conditions beyond those indicated in the operational sections of the specifications is not implied. Exposure to absolute maximum rating conditions for extended periods may affect device reliability.

MOSFET TYPICAL CHARACTERISTICS ($T_A = 25\text{ }^\circ\text{C}$, unless otherwise noted)

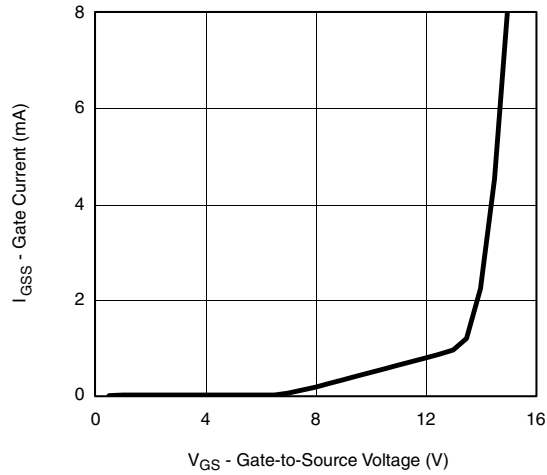

Gate-Current vs. Gate-Source Voltage

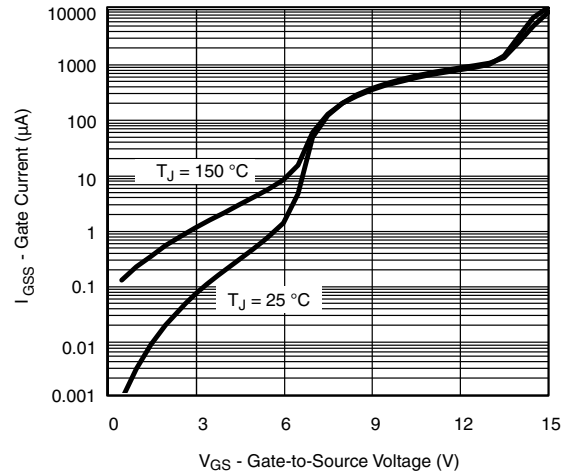

Gate Current vs. Gate-Source Voltage

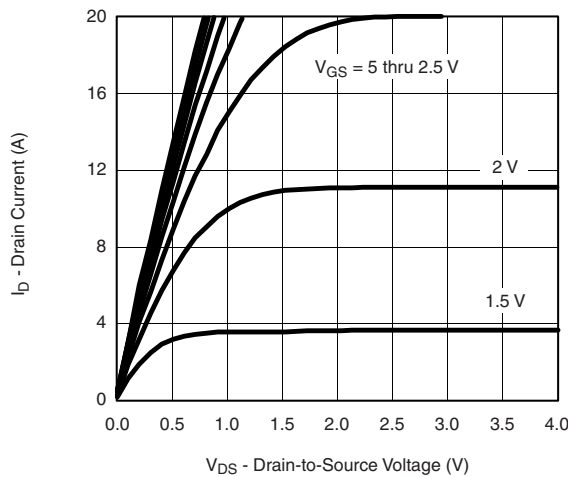

Output Characteristics

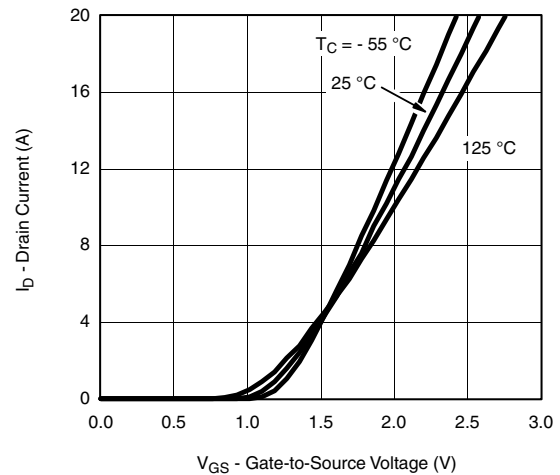

Transfer Characteristics

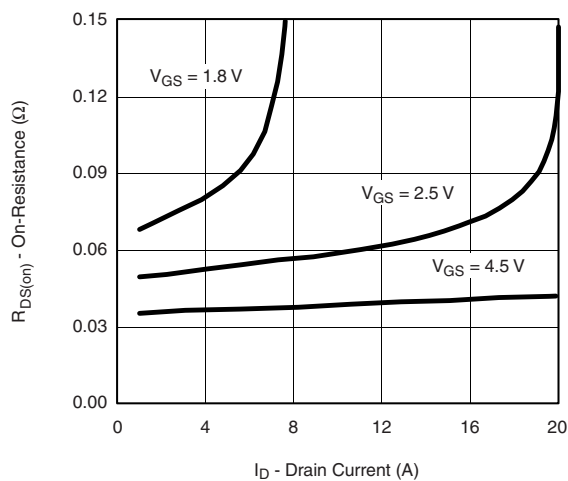

On-Resistance vs. Drain Current

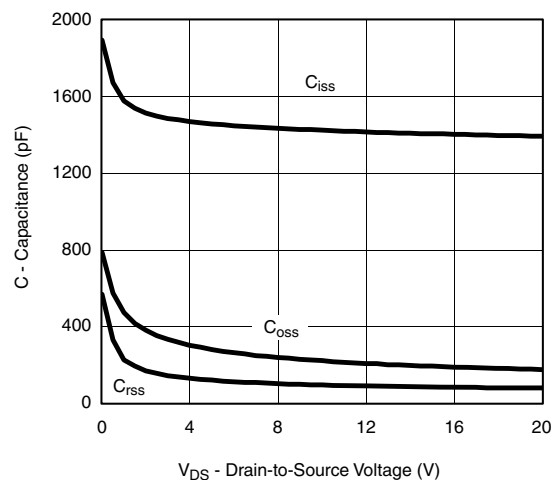

Capacitance

MOSFET TYPICAL CHARACTERISTICS ($T_A = 25\text{ }^\circ\text{C}$, unless otherwise noted)

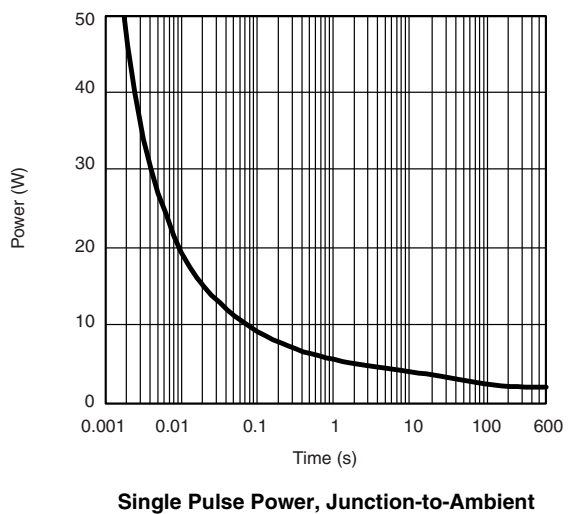
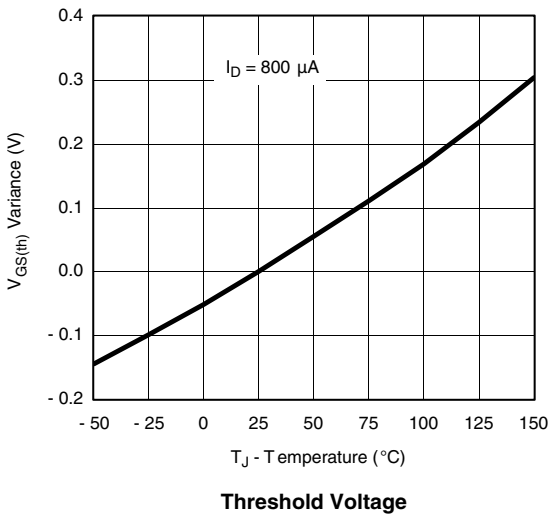
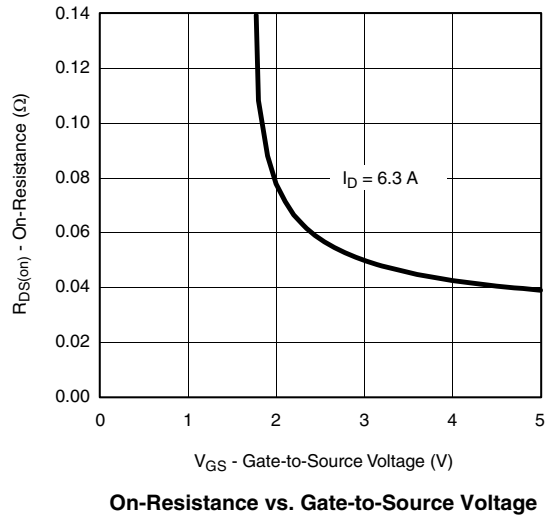
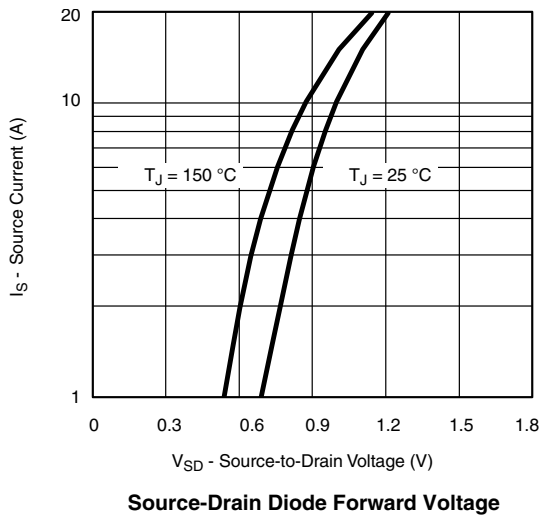
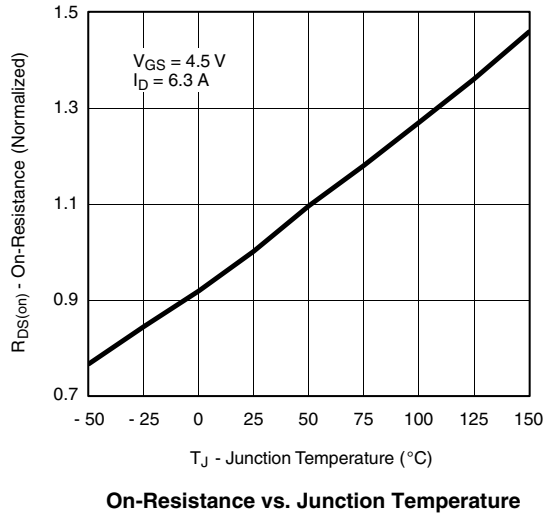
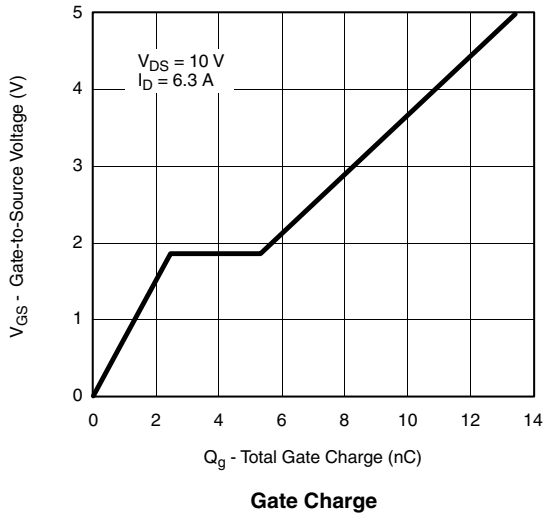

MOSFET TYPICAL CHARACTERISTICS ($T_A = 25\text{ }^\circ\text{C}$, unless otherwise noted)

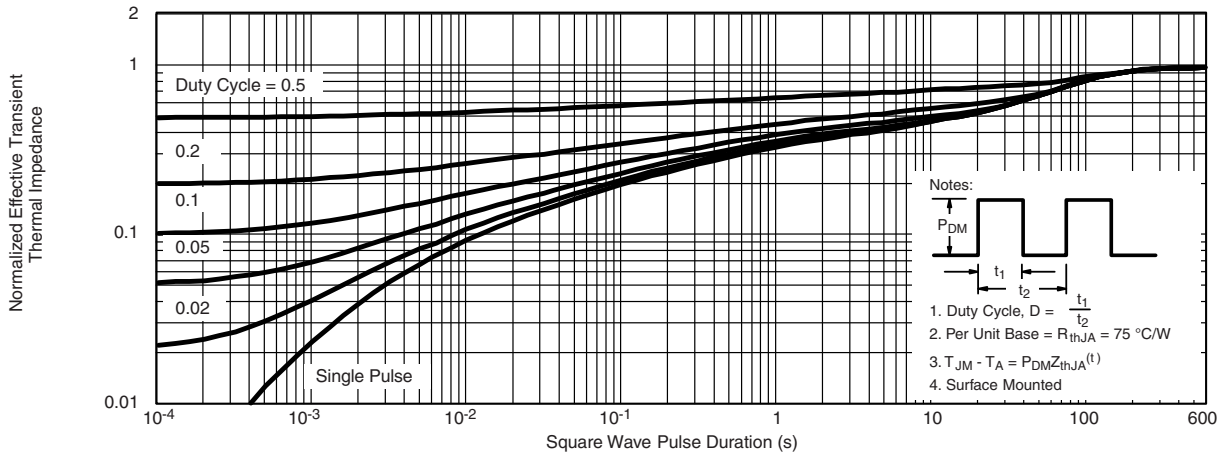

Normalized Thermal Transient Impedance, Junction-to-Ambient

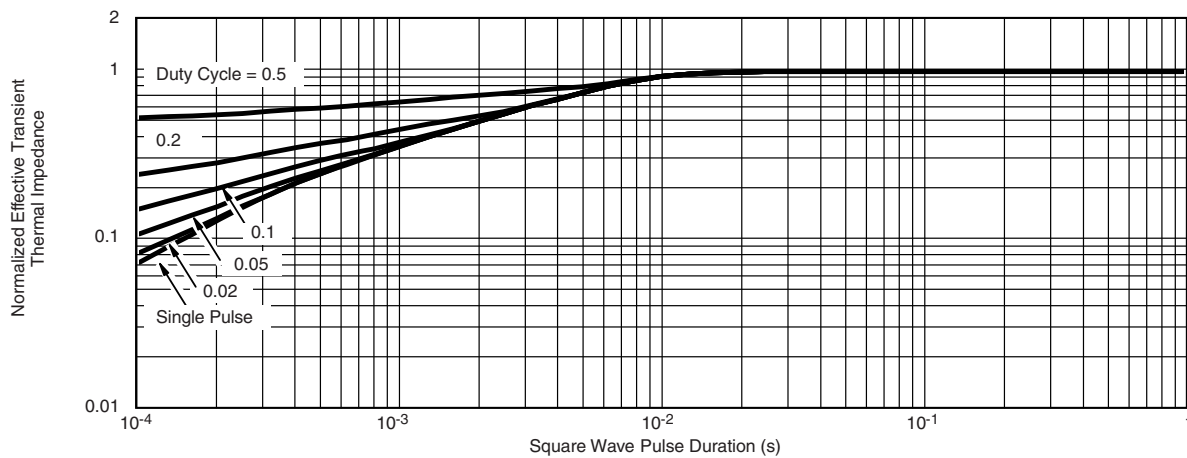

Normalized Thermal Transient Impedance, Junction-to-Case

SCHOTTKY TYPICAL CHARACTERISTICS ($T_A = 25\text{ }^\circ\text{C}$, unless otherwise noted)

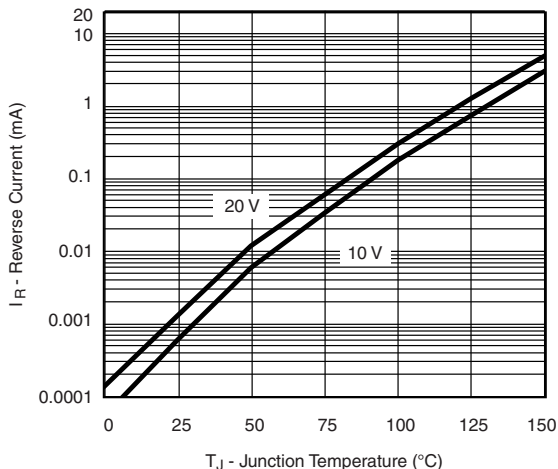

Reverse Current vs. Junction Temperature

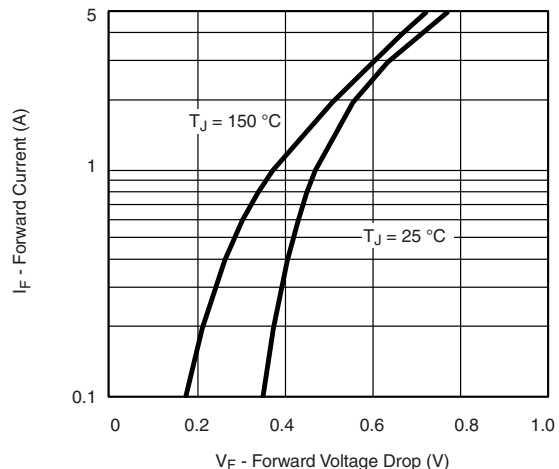

Forward Voltage Drop

SCHOTTKY TYPICAL CHARACTERISTICS ($T_A = 25\text{ }^\circ\text{C}$, unless otherwise noted)

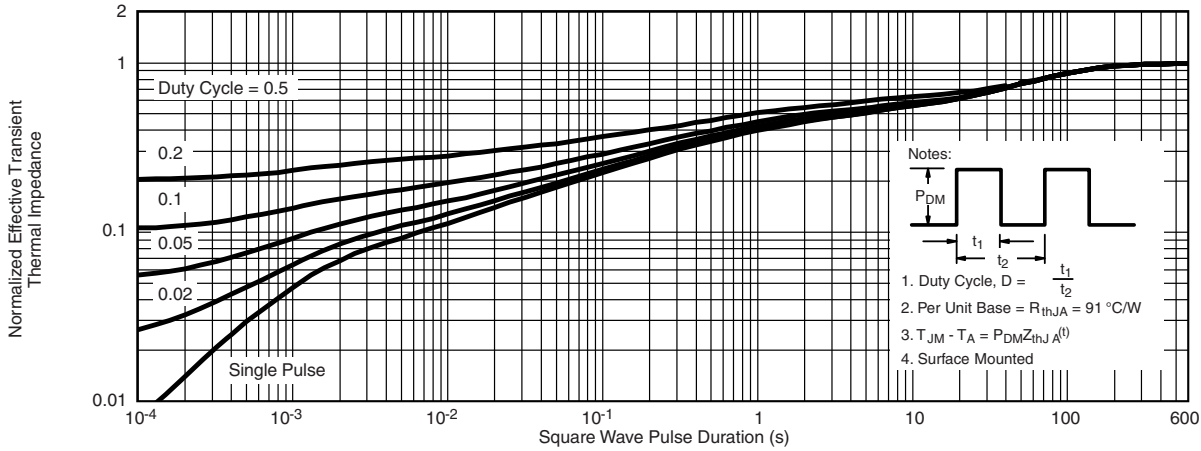
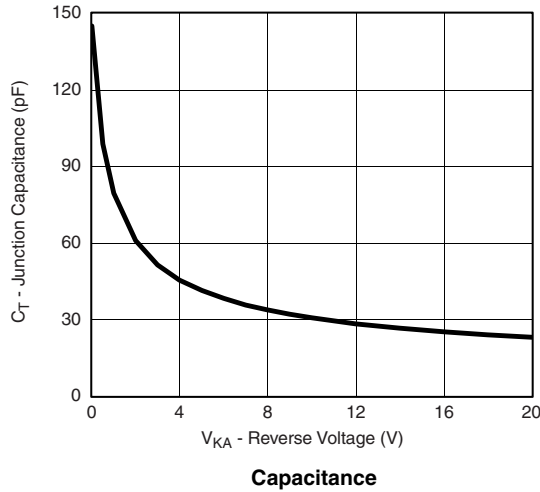

Normalized Thermal Transient Impedance, Junction-to-Ambient

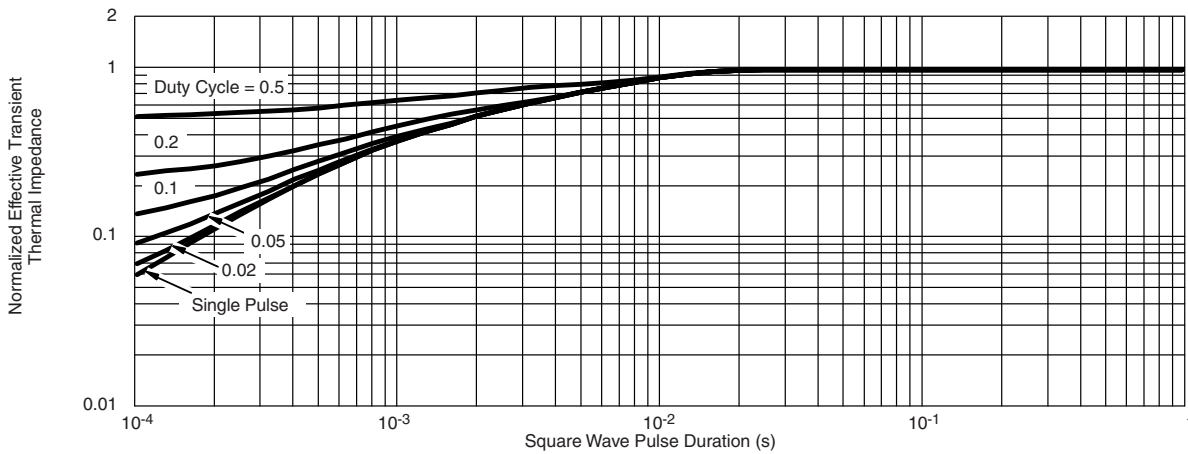

Normalized Thermal Transient Impedance, Junction-to-Case

Vishay Siliconix maintains worldwide manufacturing capability. Products may be manufactured at one of several qualified locations. Reliability data for Silicon Technology and Package Reliability represent a composite of all qualified locations. For related documents such as package/tape drawings, part marking, and reliability data, see www.vishay.com/ppg?71429.



Disclaimer

ALL PRODUCT, PRODUCT SPECIFICATIONS AND DATA ARE SUBJECT TO CHANGE WITHOUT NOTICE TO IMPROVE RELIABILITY, FUNCTION OR DESIGN OR OTHERWISE.

Vishay Intertechnology, Inc., its affiliates, agents, and employees, and all persons acting on its or their behalf (collectively, "Vishay"), disclaim any and all liability for any errors, inaccuracies or incompleteness contained in any datasheet or in any other disclosure relating to any product.

Vishay makes no warranty, representation or guarantee regarding the suitability of the products for any particular purpose or the continuing production of any product. To the maximum extent permitted by applicable law, Vishay disclaims (i) any and all liability arising out of the application or use of any product, (ii) any and all liability, including without limitation special, consequential or incidental damages, and (iii) any and all implied warranties, including warranties of fitness for particular purpose, non-infringement and merchantability.

Statements regarding the suitability of products for certain types of applications are based on Vishay's knowledge of typical requirements that are often placed on Vishay products in generic applications. Such statements are not binding statements about the suitability of products for a particular application. It is the customer's responsibility to validate that a particular product with the properties described in the product specification is suitable for use in a particular application. Parameters provided in datasheets and / or specifications may vary in different applications and performance may vary over time. All operating parameters, including typical parameters, must be validated for each customer application by the customer's technical experts. Product specifications do not expand or otherwise modify Vishay's terms and conditions of purchase, including but not limited to the warranty expressed therein.

Hyperlinks included in this datasheet may direct users to third-party websites. These links are provided as a convenience and for informational purposes only. Inclusion of these hyperlinks does not constitute an endorsement or an approval by Vishay of any of the products, services or opinions of the corporation, organization or individual associated with the third-party website. Vishay disclaims any and all liability and bears no responsibility for the accuracy, legality or content of the third-party website or for that of subsequent links.

Except as expressly indicated in writing, Vishay products are not designed for use in medical, life-saving, or life-sustaining applications or for any other application in which the failure of the Vishay product could result in personal injury or death. Customers using or selling Vishay products not expressly indicated for use in such applications do so at their own risk. Please contact authorized Vishay personnel to obtain written terms and conditions regarding products designed for such applications.

No license, express or implied, by estoppel or otherwise, to any intellectual property rights is granted by this document or by any conduct of Vishay. Product names and markings noted herein may be trademarks of their respective owners.