

Little Star® 1 W Power SMD LED White

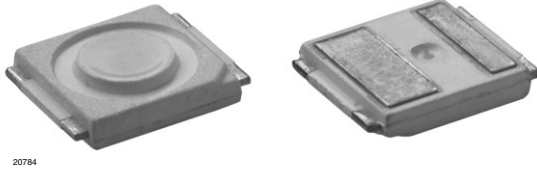

20784

DESCRIPTION

The VLMW711. is one of the most robust and light efficient LEDs in the market. With its extremely high level of brightness and the ultra low high profile, which is only 1.5 mm are highly suitable for both conventional lighting and specialized application such as automotive signal lights, traffic lights, channel lights, tube lights and garden lights among others.

PRODUCT GROUP AND PACKAGE DATA

- Product group: LED
- Package: SMD Little Star
- Product series: power
- Angle of half intensity: $\pm 60^\circ$

FEATURES

- Super high brightness surface mount LED
- High flux output; typical 90 lm
- 120° viewing angle
- Compact package outline (L x W x H) of 6.0 x 6.0 x 1.5 mm
- Ultra low height profile - 1.5 mm
- Designed for high current drive; up to 350 mA
- Low thermal resistance; $R_{thJP} = 10$ K/W
- Qualified according to JEDEC moisture sensitivity level 2a
- Compatible to IR reflow soldering
- Little Star® are class 1M LED products. Do not view directly with optical instrument
- Component in accordance to RoHS 2002/95/EC and WEEE 2002/96/EC
- Automotive qualified AEC-Q101
- ESD-withstand voltage: up to 2 kV according to JESD22-A114-B



RoHS
COMPLIANT

APPLICATIONS

- Automotive: exterior applications, e.g.: fog-lamp, rear mirror lighting, etc.
- Communication: flashLED
- Industry: white goods (e.g.: oven, microwave, etc.)
- Lighting: garden light, architecture lighting, general lighting, etc.

PARTS TABLE

PART	LUMINOUS FLUX CORRELATION BETWEEN LUM. FLUX/LUM. INTENSITY (at $I_F = 350$ mA)	COLOR, LUMINOUS INTENSITY (at $I_F = 350$ mA)	TECHNOLOGY
VLMW711U2U3XV-GS08	White, $\phi = (87\ 400\ \text{to}\ 113\ 600)$ mlm	$I_V \text{ typ.} = 29\ 700$ mcd	InGaN

ABSOLUTE MAXIMUM RATINGS ¹⁾ VLMW711U2U3XV				
PARAMETER	TEST CONDITION	SYMBOL	VALUE	UNIT
Forward current		I_F	350	mA
Power dissipation		P_{tot}	1.4	W
Junction temperature		T_j	+ 120	°C
Surge current $t < 10 \mu s, d = 0.1$		I_{FM}	1000	mA
Operating temperature range		T_{amb}	- 40 to + 100	°C
Storage temperature range		T_{stg}	- 40 to + 100	°C
Thermal resistance junction/pin		R_{thJP}	10	K/W

Note:

Not designed for reverse operation

¹⁾ $T_{amb} = 25 \text{ °C}$, unless otherwise specified

OPTICAL AND ELECTRICAL CHARACTERISTICS ¹⁾ VLMW711U2U3XV, WHITE						
PARAMETER	TEST CONDITION	SYMBOL	MIN.	TYP.	MAX.	UNIT
Luminous flux/luminous intensity	$I_F = 350 \text{ mA}$	ϕ	87 400		113 600	mlm
		I_V		29 700		mcd
Chromaticity coordinate x acc. to CIE 1931	$I_F = 350 \text{ mA}$	x		0.33		
Chromaticity coordinate y acc. to CIE 1931	$I_F = 350 \text{ mA}$	y		0.33		
Angle of half intensity	$I_F = 350 \text{ mA}$	φ		± 60		deg
Forward voltage ²⁾	$I_F = 350 \text{ mA}$	V_F	3	3.5	4	V
Temperature coefficient of V_F	$I_F = 350 \text{ mA}$	TC_{VF}		- 3		mV/K
Temperature coefficient of I_V	$I_F = 350 \text{ mA}$	TC_{IV}		- 0.4		%/K

Note:

¹⁾ $T_{amb} = 25 \text{ °C}$, unless otherwise specified

²⁾ Forward voltages are tested at a current pulse duration of 1 ms and a tolerance of $\pm 0.05 \text{ V}$

LUMINOUS INTENSITY/FLUX CLASSIFICATION WHITE		
GROUP	LUMINOUS FLUX ϕ_V (mlm) CORRELATION TABLE	
	MIN.	MAX.
STANDARD		
U2	87 400	99 400
U3	99 400	113 600

Note:

Luminous intensity is tested at a current pulse duration of 25 ms and an accuracy of $\pm 11 \%$.

The above type numbers represent the order groups which include only a few brightness groups. Only one group will be shipped on each reel (there will be no mixing of two groups on each reel).

In order to ensure availability, single brightness groups will not be orderable.

In a similar manner for colors where wavelength groups are measured and binned, single wavelength groups will be shipped in any one reel.

In order to ensure availability, single wavelength groups will not be orderable.



CHROMATICITY COORDINATED GROUPS FOR WHITE SMD LED		
Bin	Cx	Cy
XM	0.301	0.342
	0.314	0.353
	0.315	0.343
	0.303	0.333
	0.301	0.342
XN	0.303	0.333
	0.315	0.343
	0.316	0.332
	0.305	0.322
	0.303	0.333
XO	0.305	0.322
	0.316	0.332
	0.318	0.319
	0.308	0.311
	0.305	0.322
XP	0.308	0.311
	0.318	0.319
	0.320	0.301
	0.311	0.293
	0.308	0.311
WM	0.314	0.353
	0.329	0.366
	0.329	0.354
	0.315	0.343
	0.314	0.353
WN	0.315	0.343
	0.329	0.354
	0.329	0.343
	0.316	0.332
	0.315	0.343
WO	0.316	0.332
	0.329	0.343
	0.329	0.330
	0.318	0.319
	0.316	0.332
WP	0.318	0.319
	0.329	0.330
	0.329	0.319
	0.319	0.310
	0.318	0.319
WQ	0.319	0.310
	0.329	0.319
	0.330	0.311
	0.320	0.301
	0.319	0.310
VM	0.329	0.366
	0.348	0.383
	0.347	0.368
	0.329	0.354
	0.329	0.366
VN	0.329	0.354
	0.347	0.368
	0.346	0.357
	0.329	0.343
	0.329	0.354
VO	0.329	0.343
	0.346	0.357
	0.344	0.343
	0.329	0.330
	0.329	0.343
VP	0.329	0.330
	0.344	0.343
	0.343	0.331
	0.329	0.319
	0.329	0.330

Note:

Chromaticity coordinate groups are tested at a current pulse duration of 25 ms and a tolerance of ± 0.01 .

TYPICAL CHARACTERISTICS

$T_{amb} = 25\text{ }^{\circ}\text{C}$, unless otherwise specified

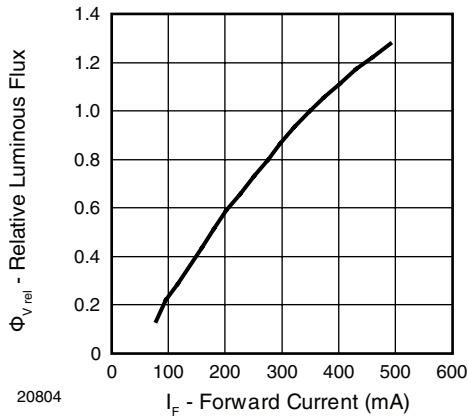

Figure 1. Relative Luminous Flux vs. Forward Current

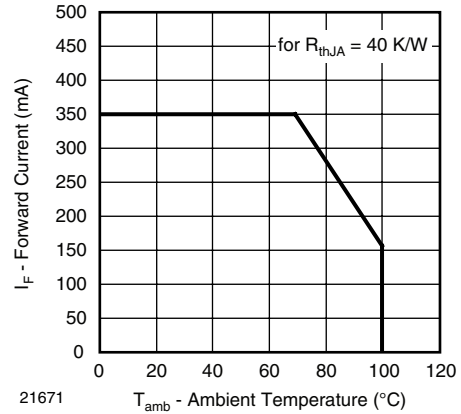

Figure 4. Max. Permissible Forward Current vs. Ambient Temperature

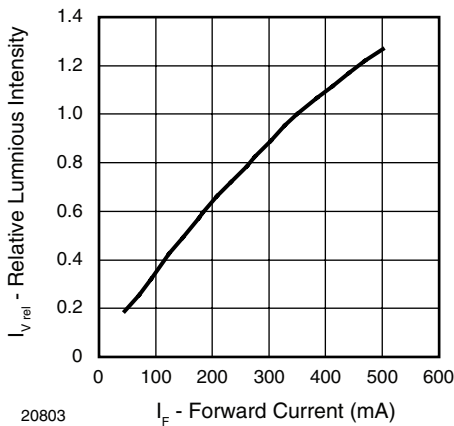

Figure 2. Relative Luminous Intensity vs. Forward Current

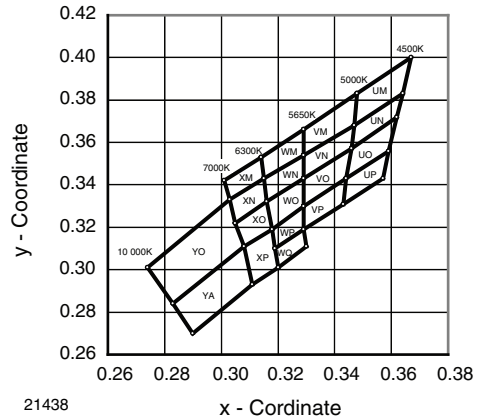

Figure 5. Coordinates of Color Groups

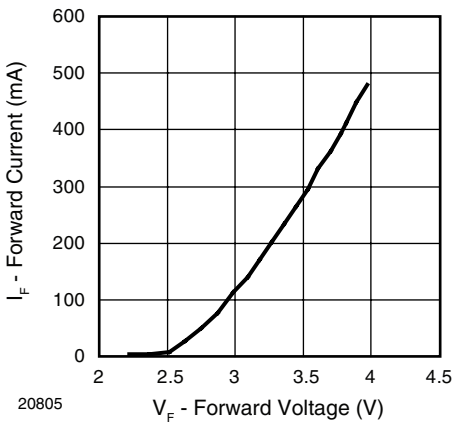

Figure 3. Forward Current vs. Forward Voltage

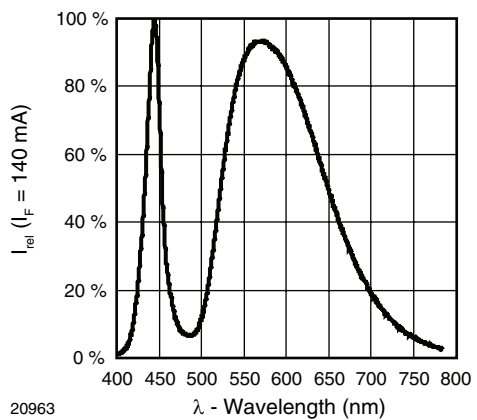

Figure 6. Relative Spectrale Emission

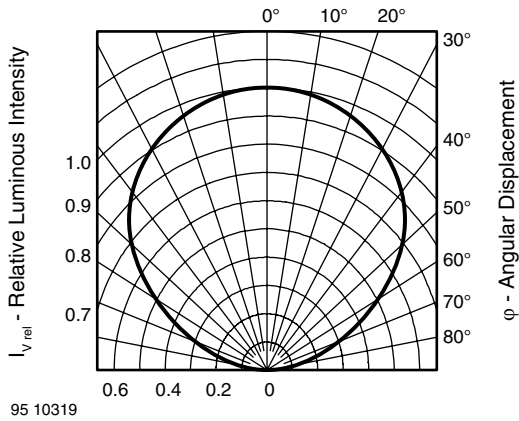
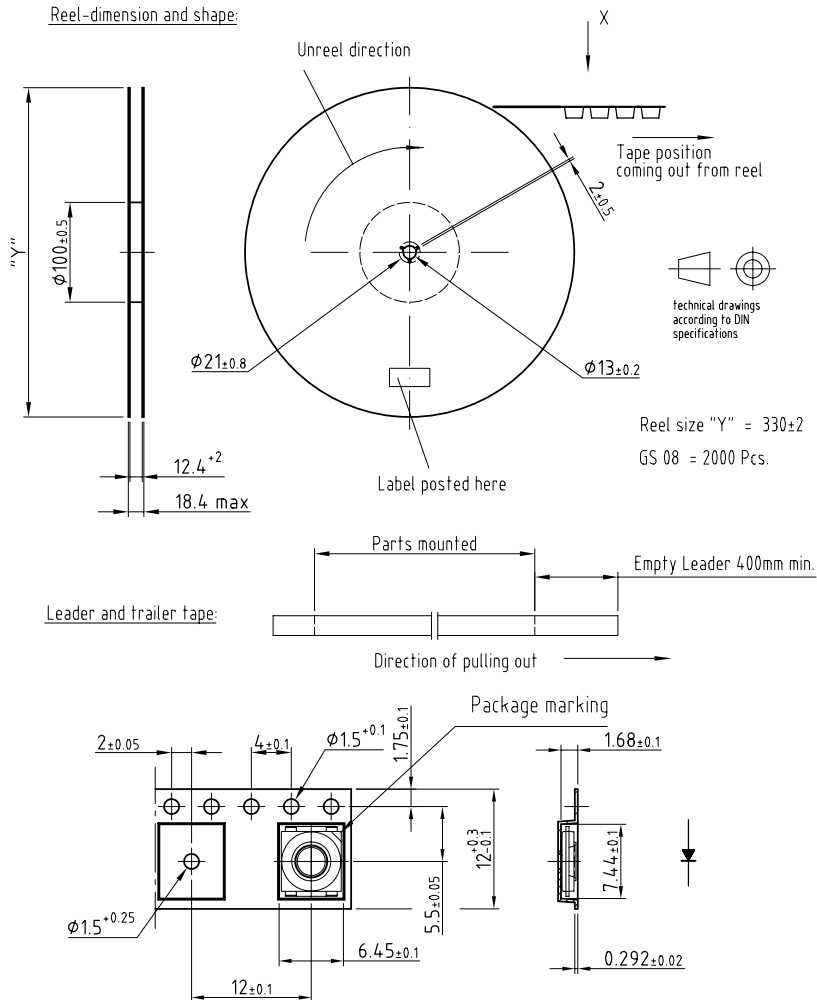

Figure 7. Relative Luminous Intensity vs. Angular Displacement

TAPING DIMENSIONS in millimeters



Drawing-No: 9.800-5094.01-4
Issue: 3, 22.01.08
20846

PACKAGE DIMENSIONS/SOLDERING PADS DIMENSIONS in millimeters

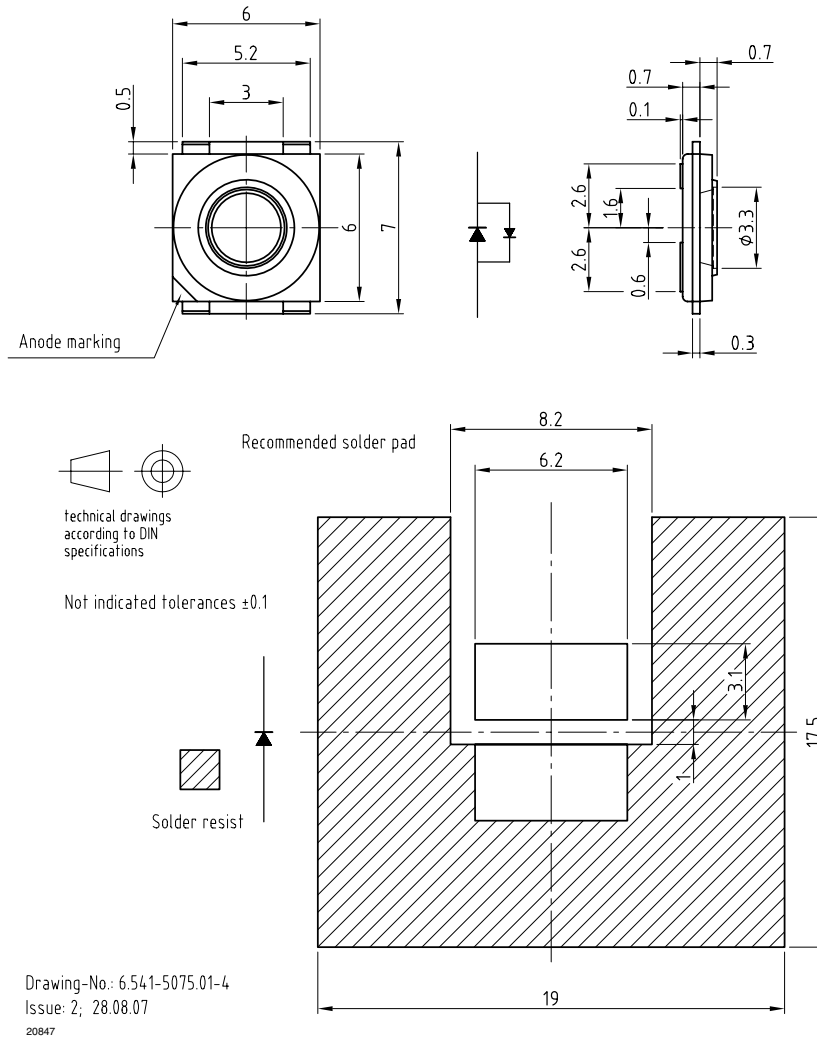

SOLDERING PROFILE

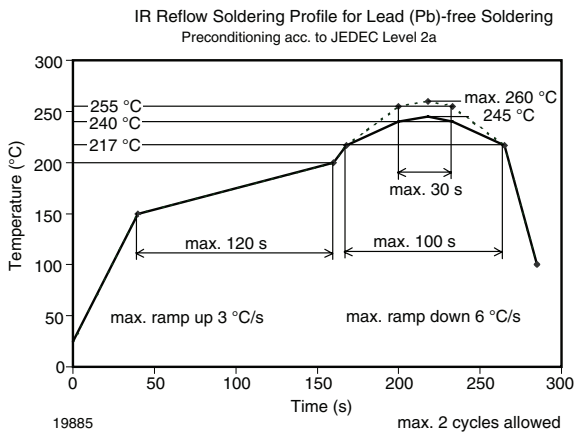
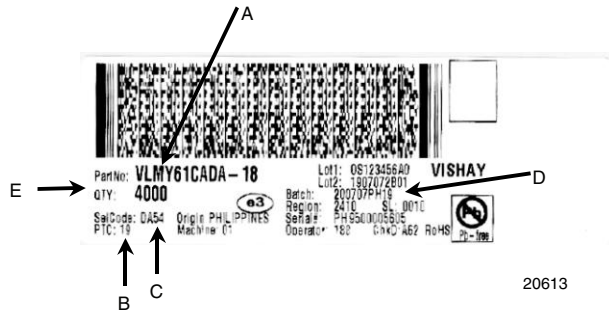

Figure 8. Vishay Lead (Pb)-free Reflow Soldering Profile (acc. to J-STD-020C)

BAR CODE PRODUCT LABEL EXAMPLE:



- A) Type of component
- B) Manufacturing plant
- C) SEL - selection code (bin):
e.g.: DA = code for luminous intensity group
5 = code for color group
- D) Batch:
200707 = year 2007, week 07
PH19 = plant code
- E) Total quantity

DRY PACKING

The reel is packed in an anti-humidity bag to protect the devices from absorbing moisture during transportation and storage.

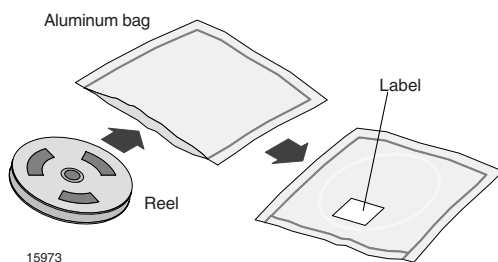

FINAL PACKING

The sealed reel is packed into a cardboard box. A secondary cardboard box is used for shipping purposes.

RECOMMENDED METHOD OF STORAGE

Dry box storage is recommended as soon as the aluminum bag has been opened to prevent moisture absorption. The following conditions should be observed, if dry boxes are not available:

- Storage temperature 10 °C to 30 °C
- Storage humidity ≤ 60 % RH max.

After more than 672 h under these conditions moisture content will be too high for reflow soldering.

In case of moisture absorption, the devices will recover to the former condition by drying under the following condition:

192 h at 40 °C + 5 °C/- 0 °C and < 5 % RH (dry air/nitrogen) or

96 h at 60 °C + 5 °C and < 5 % RH for all device containers or

24 h at 100 °C + 5 °C not suitable for reel or tubes.

An EIA JEDEC standard JESD22-A112 level 2a label is included on all dry bags.

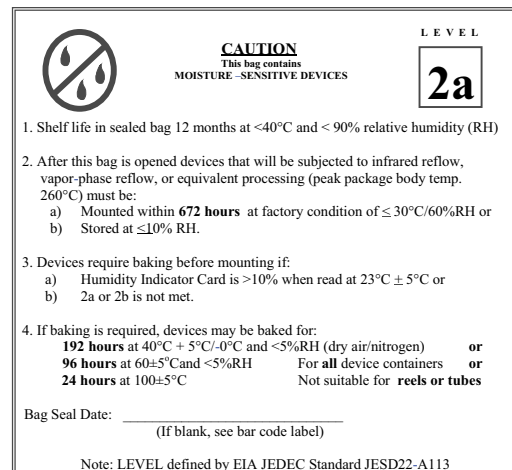

Example of JESD22-A112 level 2a label

ESD PRECAUTION

Proper storage and handling procedures should be followed to prevent ESD damage to the devices especially when they are removed from the antistatic shielding bag. Electro-static sensitive devices warning labels are on the packaging.

VISHAY SEMICONDUCTORS STANDARD BAR CODE LABELS

The Vishay Semiconductors standard bar code labels are printed at final packing areas. The labels are on each packing unit and contain Vishay Semiconductors specific data.



Disclaimer

All product specifications and data are subject to change without notice.

Vishay Intertechnology, Inc., its affiliates, agents, and employees, and all persons acting on its or their behalf (collectively, "Vishay"), disclaim any and all liability for any errors, inaccuracies or incompleteness contained herein or in any other disclosure relating to any product.

Vishay disclaims any and all liability arising out of the use or application of any product described herein or of any information provided herein to the maximum extent permitted by law. The product specifications do not expand or otherwise modify Vishay's terms and conditions of purchase, including but not limited to the warranty expressed therein, which apply to these products.

No license, express or implied, by estoppel or otherwise, to any intellectual property rights is granted by this document or by any conduct of Vishay.

The products shown herein are not designed for use in medical, life-saving, or life-sustaining applications unless otherwise expressly indicated. Customers using or selling Vishay products not expressly indicated for use in such applications do so entirely at their own risk and agree to fully indemnify Vishay for any damages arising or resulting from such use or sale. Please contact authorized Vishay personnel to obtain written terms and conditions regarding products designed for such applications.

Product names and markings noted herein may be trademarks of their respective owners.