

N- and P-Channel 30 V (D-S) MOSFET

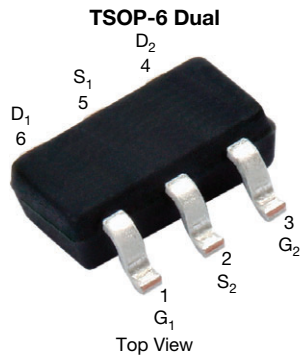

FEATURES

- TrenchFET® power MOSFET
- 100 % R_g tested
- Material categorization: for definitions of compliance please see www.vishay.com/doc?99912



RoHS
COMPLIANT
HALOGEN
FREE
Available

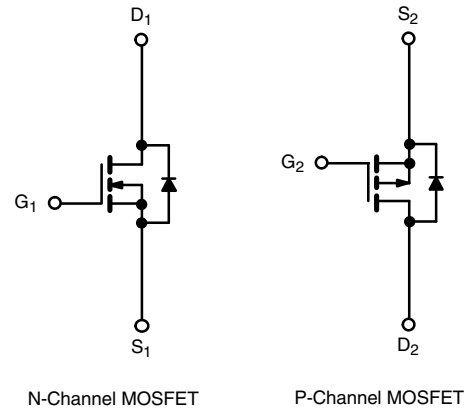

| PRODUCT SUMMARY | | |
|--|---------------|-----------|
| | N-CHANNEL | P-CHANNEL |
| V _{DS} (V) | 30 | -30 |
| R _{DS(on)} (Ω) at V _{GS} = ± 10 V | 0.105 | 0.200 |
| R _{DS(on)} (Ω) at V _{GS} = ± 4.5 V | 0.175 | 0.360 |
| Q _g typ. (nC) | 2.1 | 2.4 |
| I _D (A) ^a | 2.5 | -1.8 |
| Configuration | N- and p-pair | |

| ORDERING INFORMATION | |
|---------------------------------|-----------------|
| Package | TSOP-6 |
| Lead (Pb)-free | Si3552DV-T1-E3 |
| Lead (Pb)-free and halogen-free | Si3552DV-T1-GE3 |

| ABSOLUTE MAXIMUM RATINGS (T _A = 25 °C, unless otherwise noted) | | | | | |
|---|-----------------------------------|------------------------|-----------|------|---|
| PARAMETER | SYMBOL | N-CHANNEL | P-CHANNEL | UNIT | |
| Drain-source voltage | V _{DS} | 30 | -30 | V | |
| Gate-source voltage | V _{GS} | ± 20 | ± 20 | | |
| Continuous drain current (T _J = 150 °C) ^{a, b} | I _D | T _A = 25 °C | 2.5 | -1.8 | A |
| | | T _A = 70 °C | 2 | -1.2 | |
| Pulsed drain current | I _{DM} | 8 | -7 | | |
| Continuous source current (diode conduction) ^{a, b} | I _S | 1.05 | -1.05 | | |
| maximum power dissipation ^{a, b} | P _D | T _A = 25 °C | 1.15 | | W |
| | | T _A = 70 °C | 0.73 | | |
| Operating junction and storage temperature range | T _J , T _{stg} | -55 to +150 | | °C | |

| THERMAL RESISTANCE RATINGS | | | | | |
|--|-------------------|--------------|---------|------|------|
| PARAMETER | SYMBOL | TYPICAL | MAXIMUM | UNIT | |
| Maximum junction-to-ambient ^a | R _{thJA} | t ≤ 5 s | 93 | 110 | °C/W |
| | | Steady state | 130 | 150 | |
| Maximum junction-to-lead | R _{thJL} | 75 | 90 | | |

Notes

- a. Surface mounted on FR4 board
b. t ≤ 5 s



| SPECIFICATIONS (T _J = 25 °C, unless otherwise noted) | | | | | | | | |
|---|---------------------|---|--|------|-------|-------|------|-------|
| PARAMETER | SYMBOL | TEST CONDITIONS | | MIN. | TYP. | MAX. | UNIT | |
| Static | | | | | | | | |
| Gate threshold voltage | V _{GS(th)} | V _{DS} = V _{GS} , I _D = 250 μA | N-Ch | 1 | - | - | V | |
| | | V _{DS} = V _{GS} , I _D = -250 μA | P-Ch | -1 | - | - | | |
| Gate-body leakage | I _{GSS} | V _{DS} = 0 V, V _{GS} = ± 20 V | N-Ch | - | - | ± 100 | nA | |
| | | | P-Ch | - | - | ± 100 | | |
| Zero gate voltage drain current | I _{DSS} | V _{DS} = 24 V, V _{GS} = 0 V | N-Ch | - | - | 1 | μA | |
| | | | P-Ch | - | - | -1 | | |
| | | | V _{DS} = 24 V, V _{GS} = 0 V, T _J = 55 °C | N-Ch | - | - | | 5 |
| | | | V _{DS} = -24 V, V _{GS} = 0 V, T _J = 55 °C | P-Ch | - | - | | -5 |
| On-state drain current ^a | I _{D(on)} | V _{DS} = 5 V, V _{GS} = 10 V | N-Ch | 5 | - | - | A | |
| | | | V _{DS} = -5 V, V _{GS} = -10 V | P-Ch | -5 | - | | - |
| Drain-source on-state resistance ^a | R _{DS(on)} | V _{GS} = 10 V, I _D = 2.5 A | N-Ch | - | 0.085 | 0.105 | Ω | |
| | | | V _{GS} = -10 V, I _D = -1.8 A | P-Ch | - | 0.165 | | 0.200 |
| | | | V _{GS} = 4.5 V, I _D = 2 A | N-Ch | - | 0.140 | | 0.175 |
| | | | V _{GS} = -4.5 V, I _D = -1.2 A | P-Ch | - | 0.298 | | 0.360 |
| Forward transconductance ^a | g _{fs} | V _{DS} = 10 V, I _D = 2.5 A | N-Ch | - | 4.3 | - | S | |
| | | | V _{DS} = -15 V, I _D = -1.8 A | P-Ch | - | 2.4 | | - |
| Diode forward voltage ^a | V _{SD} | I _S = 1.05 A, V _{GS} = 0 V | N-Ch | - | 0.81 | 1.1 | V | |
| | | I _S = -1.05 A, V _{GS} = 0 V | P-Ch | - | -0.83 | -1.1 | | |
| Dynamic ^b | | | | | | | | |
| Total gate charge | Q _g | N-Channel V _{DS} = 15 V, V _{GS} = 5 V, I _D = 1.8 A P-Channel V _{DS} = -15 V, V _{GS} = -5 V, I _D = -1.8 A | N-Ch | - | 2.1 | 3.2 | nC | |
| | | | P-Ch | - | 2.4 | 3.6 | | |
| Gate-source charge | Q _{gs} | | N-Ch | - | 0.7 | - | | |
| | | | P-Ch | - | 0.9 | - | | |
| Gate-drain charge | Q _{gd} | | N-Ch | - | 0.7 | - | | |
| | | | P-Ch | - | 0.8 | - | | |
| Gate resistance | R _g | N-Ch | 0.5 | - | 2.4 | Ω | | |
| | | P-Ch | 3 | - | 11 | | | |
| Turn-on delay time | t _{d(on)} | N-Channel V _{DD} = 15 V, R _L = 15 Ω I _D ≅ 1 A, V _{GEN} = 10 V, R _g = 6 Ω P-Channel V _{DD} = -15 V, R _L = 15 Ω I _D ≅ -1 A, V _{GEN} = -10 V, R _g = 6 Ω | N-Ch | - | 7 | 11 | ns | |
| | | | P-Ch | - | 8 | 12 | | |
| Rise time | t _r | | N-Ch | - | 9 | 14 | | |
| | | | P-Ch | - | 12 | 18 | | |
| Turn-off delay time | t _{d(off)} | | N-Ch | - | 13 | 20 | | |
| | | | P-Ch | - | 12 | 18 | | |
| Fall time | t _f | | N-Ch | - | 5 | 8 | | |
| | | | P-Ch | - | 7 | 11 | | |
| Source-drain reverse recovery time | t _{rr} | I _F = 1.05 A, di/dt = 100 A/μs | N-Ch | - | 35 | 60 | | |
| | | I _F = -1.05 A, di/dt = 100 A/μs | P-Ch | - | 30 | 60 | | |

Notes

- a. Pulse test; pulse width ≤ 300 μs, duty cycle ≤ 2 %
- b. Guaranteed by design, not subject to production testing

Stresses beyond those listed under "Absolute Maximum Ratings" may cause permanent damage to the device. These are stress ratings only, and functional operation of the device at these or any other conditions beyond those indicated in the operational sections of the specifications is not implied. Exposure to absolute maximum rating conditions for extended periods may affect device reliability.



N-CHANNEL TYPICAL CHARACTERISTICS (25 °C, unless otherwise noted)

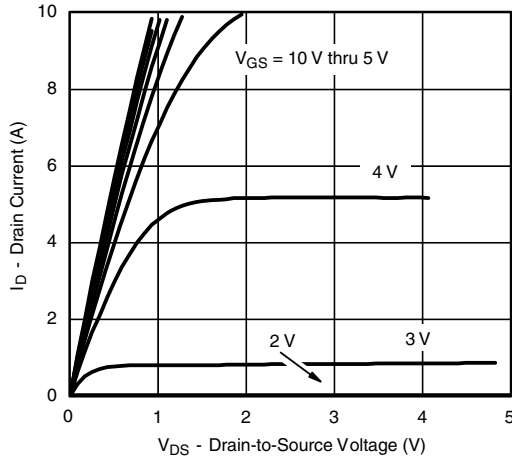

Output Characteristics

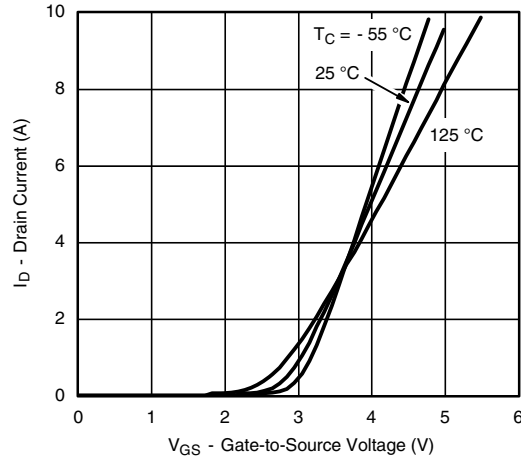

Transfer Characteristics

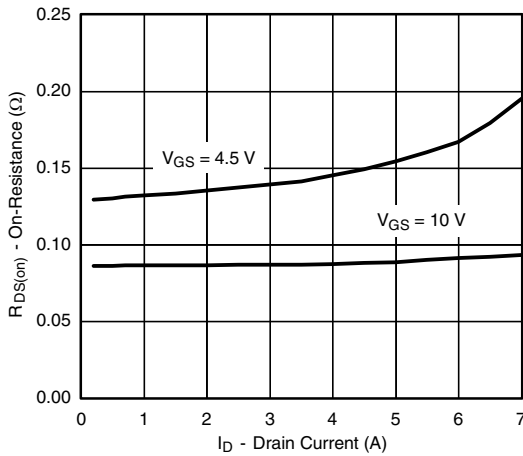

On-Resistance vs. Drain Current

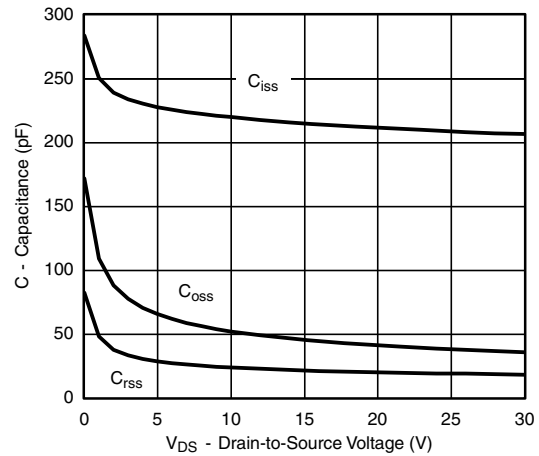

Capacitance

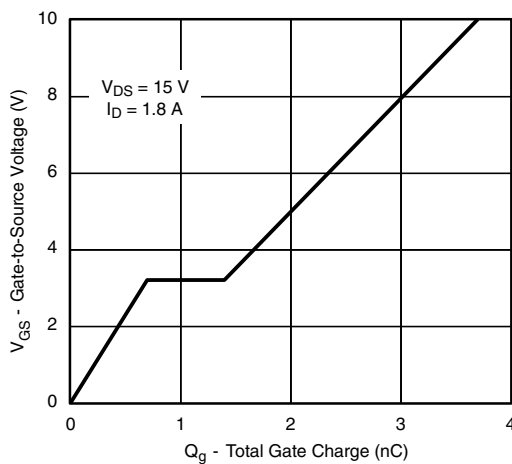

Gate Charge

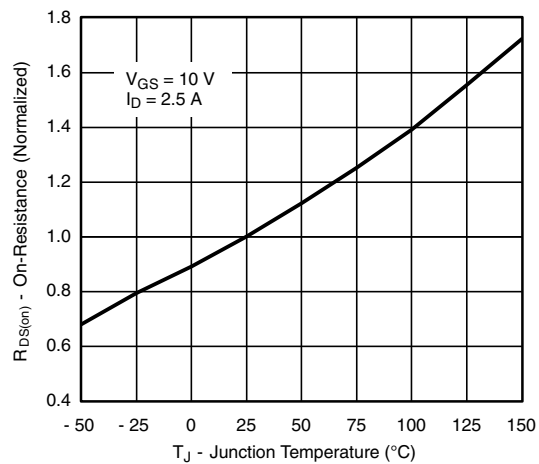

On-Resistance vs. Junction Temperature



N-CHANNEL TYPICAL CHARACTERISTICS (25 °C, unless otherwise noted)

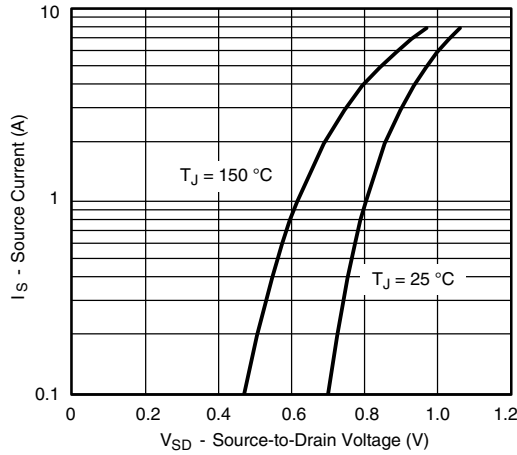

Source-Drain Diode Forward Voltage

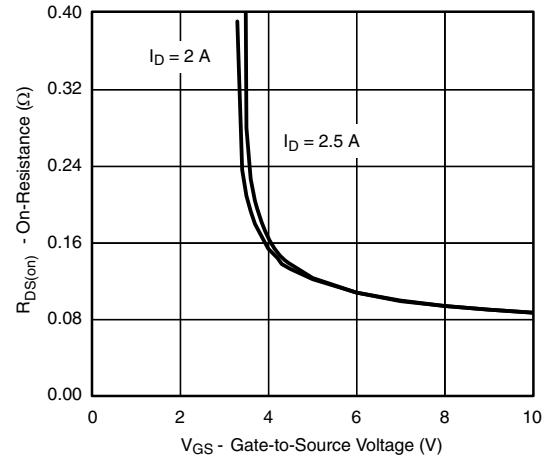

On-Resistance vs. Gate-to-Source Voltage

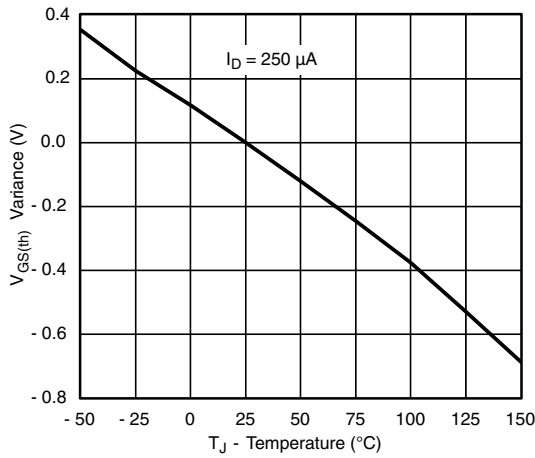

Threshold Voltage

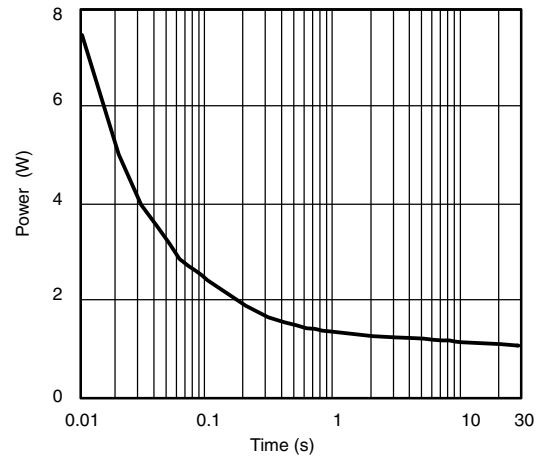

Single Pulse Power (Junction-to-Ambient)



N-CHANNEL TYPICAL CHARACTERISTICS (25 °C, unless otherwise noted)

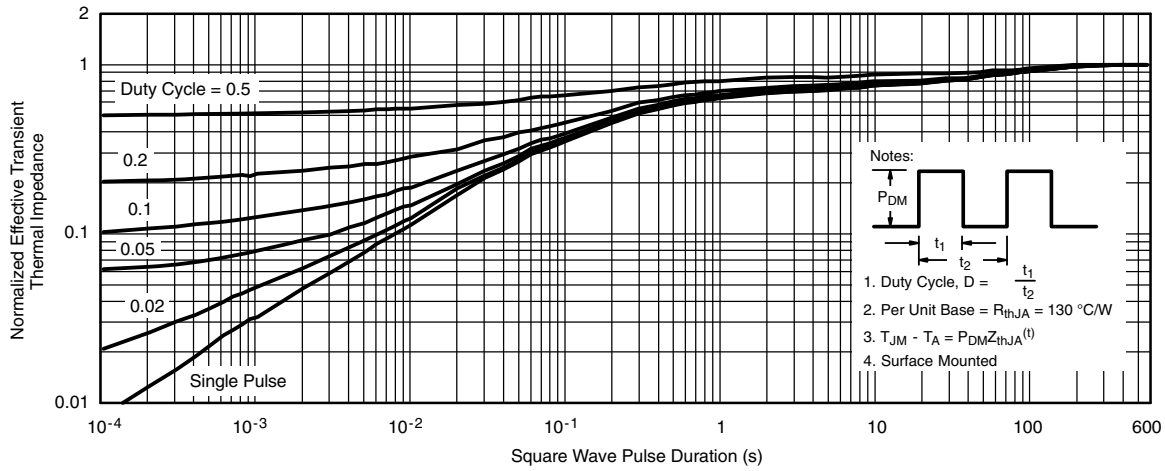

Normalized Thermal Transient Impedance, Junction-to-Ambient

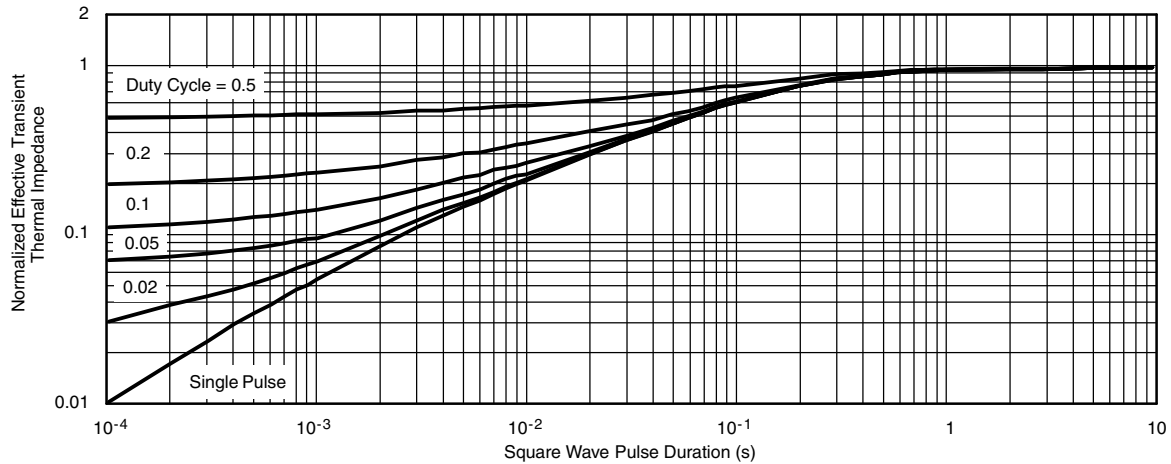

Normalized Thermal Transient Impedance, Junction-to-Foot

P-CHANNEL TYPICAL CHARACTERISTICS (25 °C, unless otherwise noted)

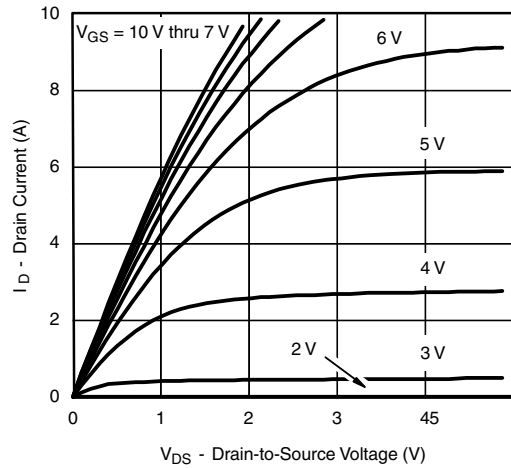

Output Characteristics

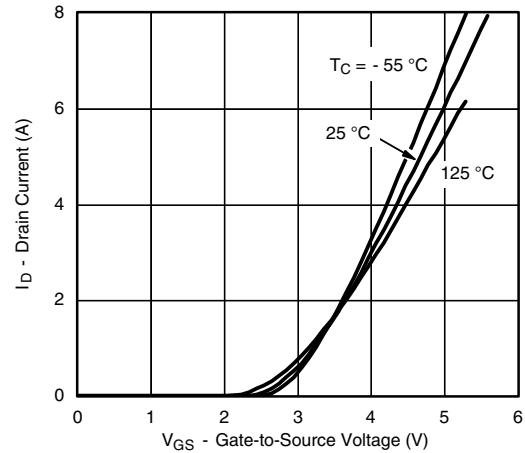

Transfer Characteristics

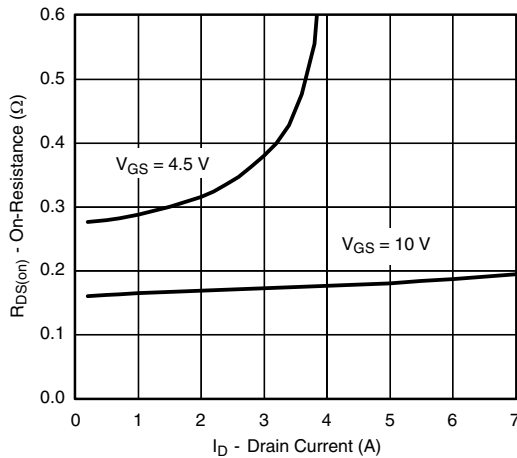

On-Resistance vs. Drain Current

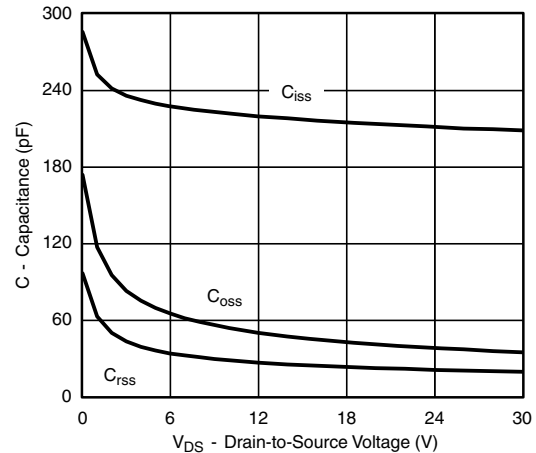

Capacitance

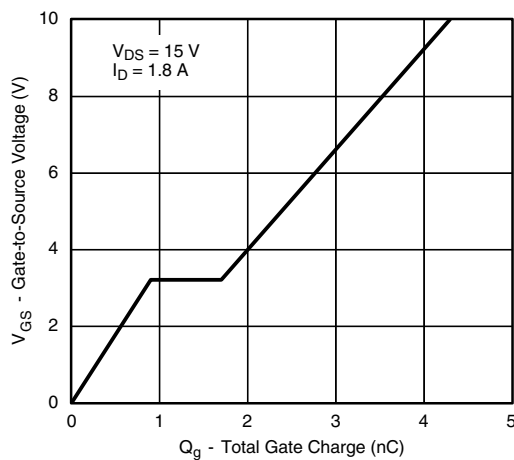

Gate Charge

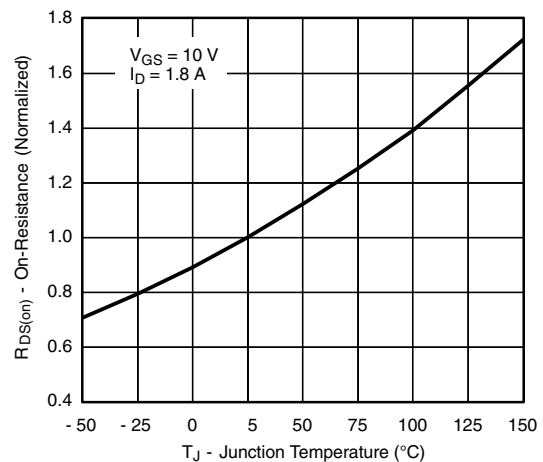

On-Resistance vs. Junction Temperature



P-CHANNEL TYPICAL CHARACTERISTICS (25 °C, unless otherwise noted)

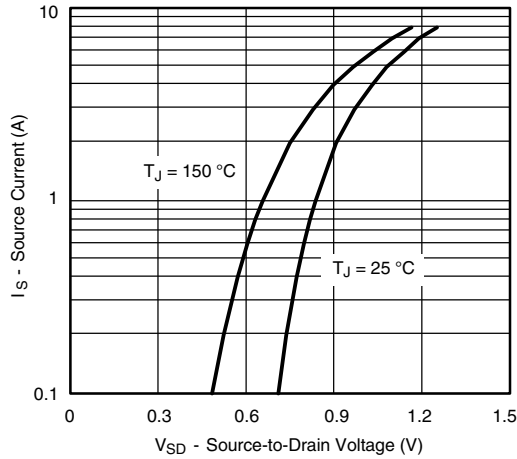

Source-Drain Diode Forward Voltage

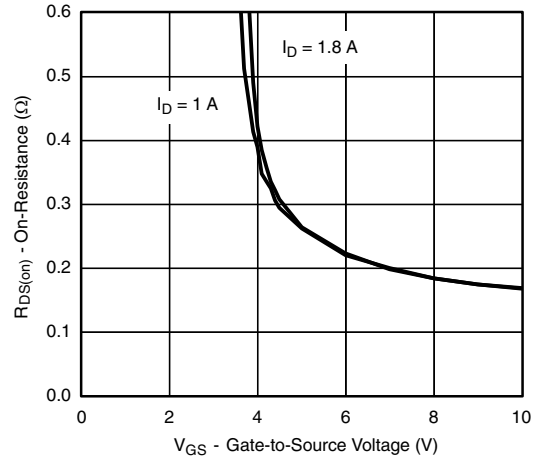

On-Resistance vs. Gate-to-Source Voltage

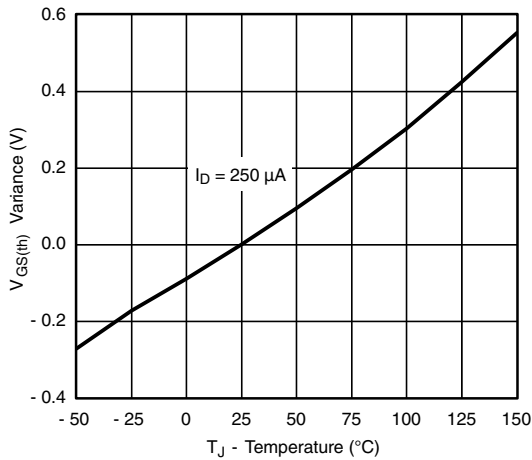

Threshold Voltage

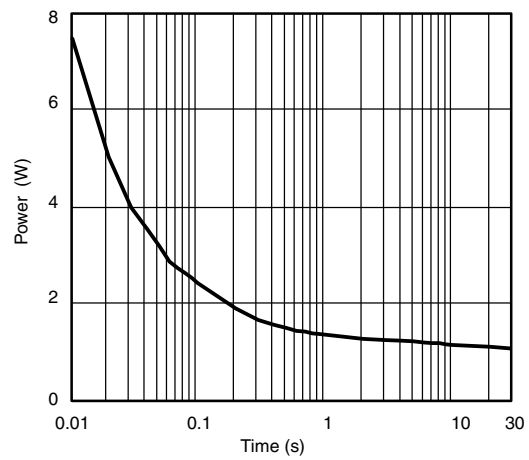

Single Pulse Power (Junction-to-Ambient)

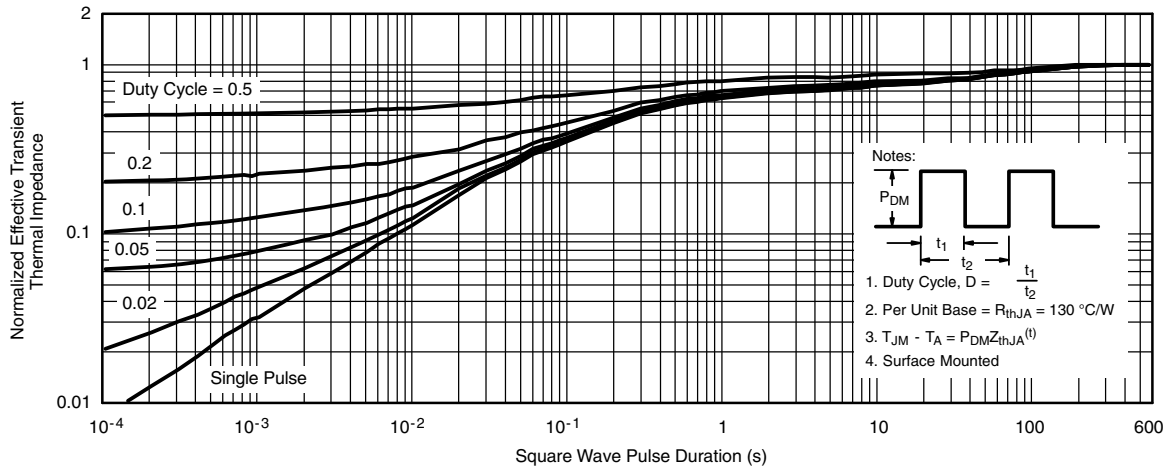
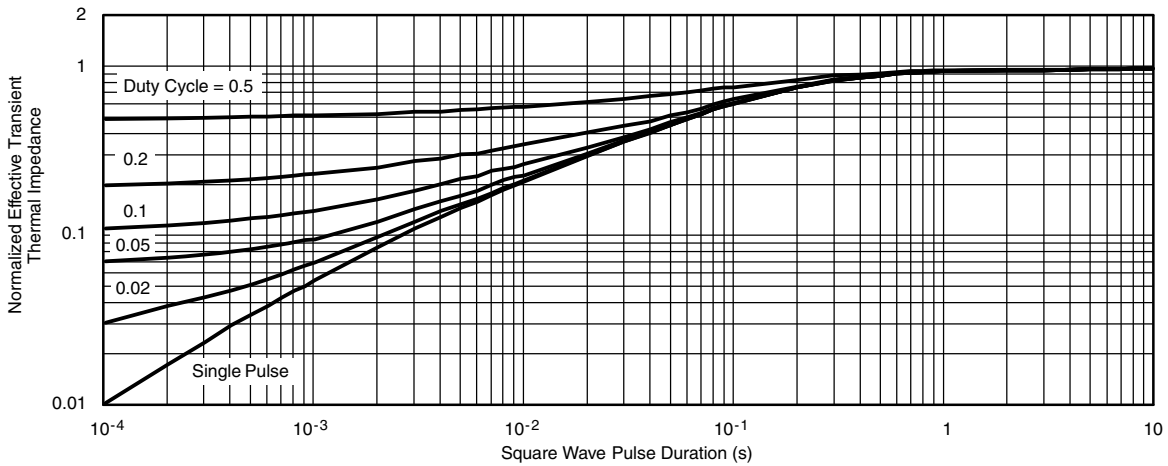
P-CHANNEL TYPICAL CHARACTERISTICS (25 °C, unless otherwise noted)

Normalized Thermal Transient Impedance, Junction-to-Ambient

Normalized Thermal Transient Impedance, Junction-to-Foot

Vishay Siliconix maintains worldwide manufacturing capability. Products may be manufactured at one of several qualified locations. Reliability data for Silicon Technology and Package Reliability represent a composite of all qualified locations. For related documents such as package / tape drawings, part marking, and reliability data, see www.vishay.com/ppg?70971.

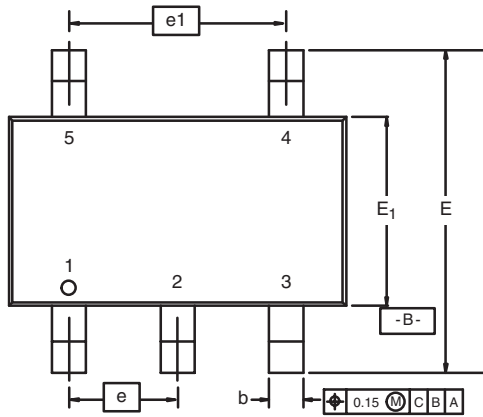
TSOP: 5/6-LEAD

JEDEC Part Number: MO-193C



5-LEAD TSOP

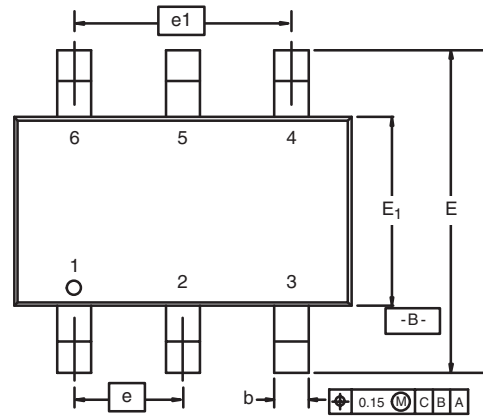

6-LEAD TSOP

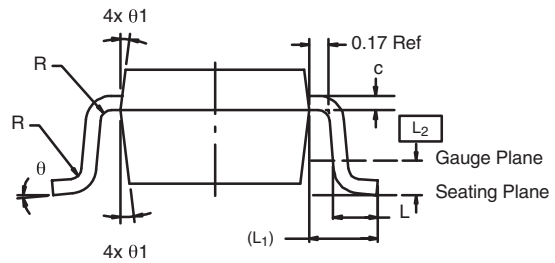
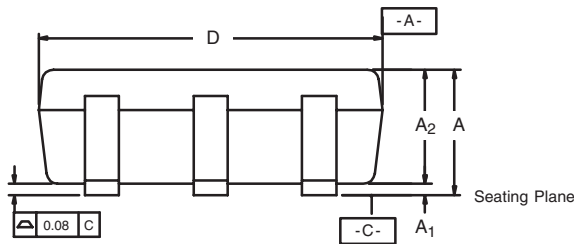

| Dim | MILLIMETERS | | | INCHES | | |
|--------------------------------|-------------|------|------|------------|-------|-------|
| | Min | Nom | Max | Min | Nom | Max |
| A | 0.91 | - | 1.10 | 0.036 | - | 0.043 |
| A₁ | 0.01 | - | 0.10 | 0.0004 | - | 0.004 |
| A₂ | 0.90 | - | 1.00 | 0.035 | 0.038 | 0.039 |
| b | 0.30 | 0.32 | 0.45 | 0.012 | 0.013 | 0.018 |
| c | 0.10 | 0.15 | 0.20 | 0.004 | 0.006 | 0.008 |
| D | 2.95 | 3.05 | 3.10 | 0.116 | 0.120 | 0.122 |
| E | 2.70 | 2.85 | 2.98 | 0.106 | 0.112 | 0.117 |
| E₁ | 1.55 | 1.65 | 1.70 | 0.061 | 0.065 | 0.067 |
| e | 0.95 BSC | | | 0.0374 BSC | | |
| e₁ | 1.80 | 1.90 | 2.00 | 0.071 | 0.075 | 0.079 |
| L | 0.32 | - | 0.50 | 0.012 | - | 0.020 |
| L₁ | 0.60 Ref | | | 0.024 Ref | | |
| L₂ | 0.25 BSC | | | 0.010 BSC | | |
| R | 0.10 | - | - | 0.004 | - | - |
| θ | 0° | 4° | 8° | 0° | 4° | 8° |
| θ₁ | 7° Nom | | | 7° Nom | | |
| ECN: C-06593-Rev. I, 18-Dec-06 | | | | | | |
| DWG: 5540 | | | | | | |

Mounting LITTLE FOOT[®] TSOP-6 Power MOSFETs

Surface mounted power MOSFET packaging has been based on integrated circuit and small signal packages. Those packages have been modified to provide the improvements in heat transfer required by power MOSFETs. Leadframe materials and design, molding compounds, and die attach materials have been changed. What has remained the same is the footprint of the packages.

The basis of the pad design for surface mounted power MOSFET is the basic footprint for the package. For the TSOP-6 package outline drawing see <http://www.vishay.com/doc?71200> and see <http://www.vishay.com/doc?72610> for the minimum pad footprint. In converting the footprint to the pad set for a power MOSFET, you must remember that not only do you want to make electrical connection to the package, but you must make thermal connection and provide a means to draw heat from the package, and move it away from the package.

In the case of the TSOP-6 package, the electrical connections are very simple. Pins 1, 2, 5, and 6 are the drain of the MOSFET and are connected together. For a small signal device or integrated circuit, typical connections would be made with traces that are 0.020 inches wide. Since the drain pins serve the additional function of providing the thermal connection to the package, this level of connection is inadequate. The total cross section of the copper may be adequate to carry the current required for the application, but it presents a large thermal impedance. Also, heat spreads in a circular fashion from the heat source. In this case the drain pins are the heat sources when looking at heat spread on the PC board.

Figure 1 shows the copper spreading recommended footprint for the TSOP-6 package. This pattern shows the starting point for utilizing the board area available for the heat spreading copper. To create this pattern, a plane of copper overlays the basic pattern on pins 1,2,5, and 6. The copper plane connects the drain pins electrically, but more importantly provides planar copper to draw heat from the drain leads and start the process of spreading the heat so it can be dissipated into the ambient air. Notice that the planar copper is shaped like a "T" to move heat away from the drain leads in all directions. This pattern uses all the available area underneath the body for this purpose.

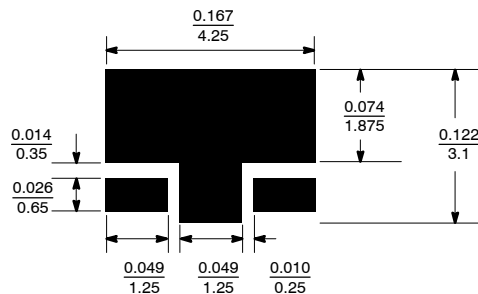

FIGURE 1. Recommended Copper Spreading Footprint

Since surface mounted packages are small, and reflow soldering is the most common form of soldering for surface mount components, "thermal" connections from the planar copper to the pads have not been used. Even if additional planar copper area is used, there should be no problems in the soldering process. The actual solder connections are defined by the solder mask openings. By combining the basic footprint with the copper plane on the drain pins, the solder mask generation occurs automatically.

A final item to keep in mind is the width of the power traces. The absolute minimum power trace width must be determined by the amount of current it has to carry. For thermal reasons, this minimum width should be at least 0.020 inches. The use of wide traces connected to the drain plane provides a low impedance path for heat to move away from the device.

REFLOW SOLDERING

Vishay Siliconix surface-mount packages meet solder reflow reliability requirements. Devices are subjected to solder reflow as a test preconditioning and are then reliability-tested using temperature cycle, bias humidity, HAST, or pressure pot. The solder reflow temperature profile used, and the temperatures and time duration, are shown in Figures 2 and 3.

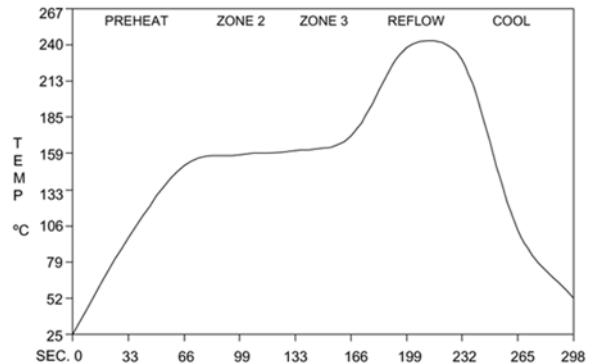

| | |
|-----------------------------|---------------------|
| Ramp-Up Rate | +6°C/Second Maximum |
| Temperature @ 155 ± 15°C | 120 Seconds Maximum |
| Temperature Above 180°C | 70 – 180 Seconds |
| Maximum Temperature | 240 +5/-0°C |
| Time at Maximum Temperature | 20 – 40 Seconds |
| Ramp-Down Rate | +6°C/Second Maximum |

FIGURE 2. Solder Reflow Temperature Profile

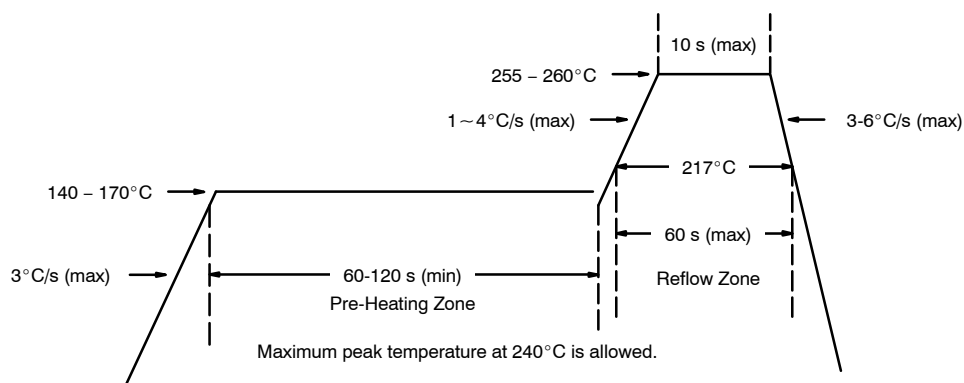

FIGURE 3. Solder Reflow Temperature and Time Durations

THERMAL PERFORMANCE

A basic measure of a device's thermal performance is the junction-to-case thermal resistance, $R_{\theta_{JC}}$, or the junction-to-foot thermal resistance, $R_{\theta_{JF}}$. This parameter is measured for the device mounted to an infinite heat sink and is therefore a characterization of the device only, in other words, independent of the properties of the object to which the device is mounted. Table 1 shows the thermal performance of the TSOP-6.

| TABLE 1. | |
|--|--------|
| Equivalent Steady State Performance—TSOP-6 | |
| Thermal Resistance $R_{\theta_{JF}}$ | 30°C/W |

SYSTEM AND ELECTRICAL IMPACT OF TSOP-6

In any design, one must take into account the change in MOSFET $r_{DS(on)}$ with temperature (Figure 4).

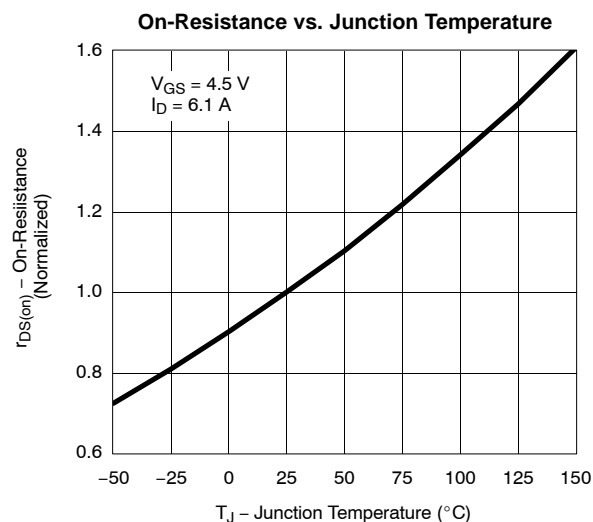
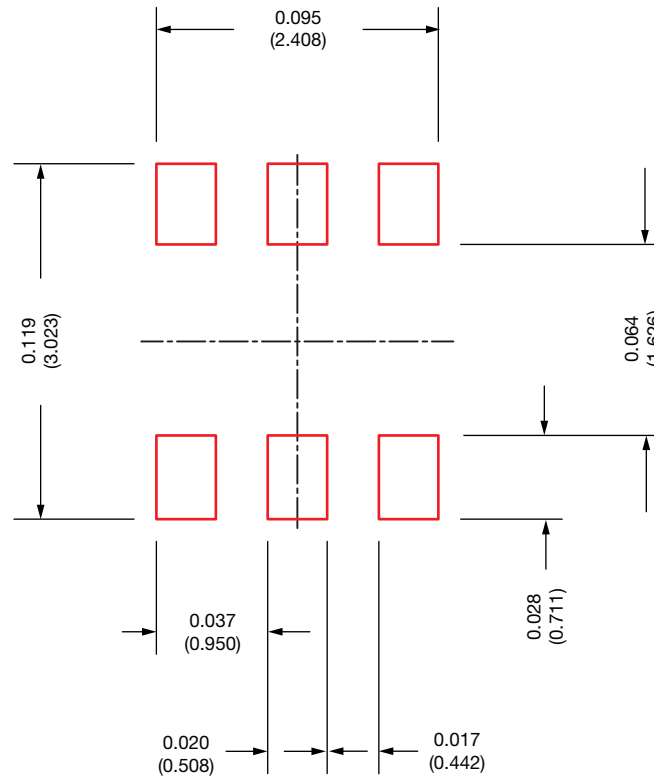
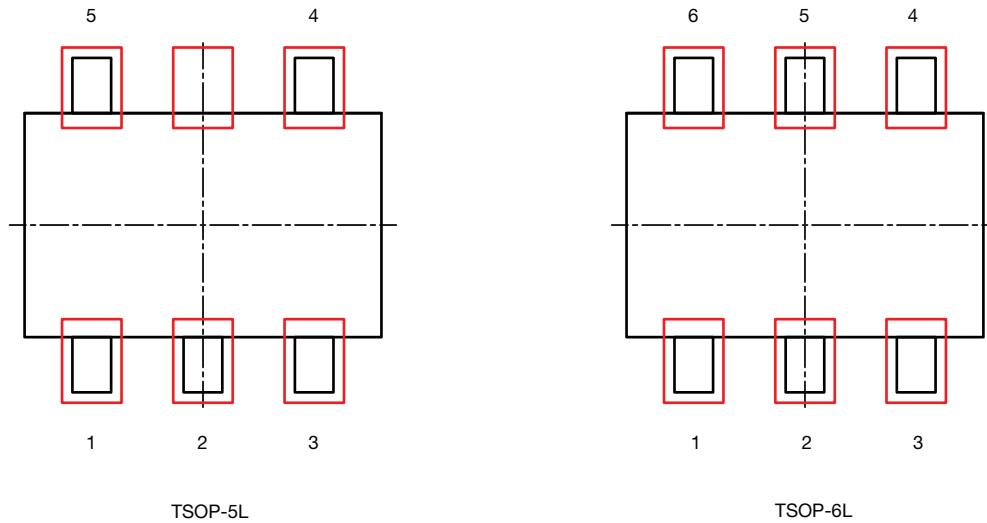

FIGURE 4. Si3434DV

Recommended Land Pattern For TSOP-5L / TSOP-6L



Note

- All dimensions are in inches (millimeter)

ECN:
S22-0593-Rev. A, 18-Jul-2022
DWG: 3010



Disclaimer

ALL PRODUCT, PRODUCT SPECIFICATIONS AND DATA ARE SUBJECT TO CHANGE WITHOUT NOTICE TO IMPROVE RELIABILITY, FUNCTION OR DESIGN OR OTHERWISE.

Vishay Intertechnology, Inc., its affiliates, agents, and employees, and all persons acting on its or their behalf (collectively, "Vishay"), disclaim any and all liability for any errors, inaccuracies or incompleteness contained in any datasheet or in any other disclosure relating to any product.

Vishay makes no warranty, representation or guarantee regarding the suitability of the products for any particular purpose or the continuing production of any product. To the maximum extent permitted by applicable law, Vishay disclaims (i) any and all liability arising out of the application or use of any product, (ii) any and all liability, including without limitation special, consequential or incidental damages, and (iii) any and all implied warranties, including warranties of fitness for particular purpose, non-infringement and merchantability.

Statements regarding the suitability of products for certain types of applications are based on Vishay's knowledge of typical requirements that are often placed on Vishay products in generic applications. Such statements are not binding statements about the suitability of products for a particular application. It is the customer's responsibility to validate that a particular product with the properties described in the product specification is suitable for use in a particular application. Parameters provided in datasheets and / or specifications may vary in different applications and performance may vary over time. All operating parameters, including typical parameters, must be validated for each customer application by the customer's technical experts. Product specifications do not expand or otherwise modify Vishay's terms and conditions of purchase, including but not limited to the warranty expressed therein.

Hyperlinks included in this datasheet may direct users to third-party websites. These links are provided as a convenience and for informational purposes only. Inclusion of these hyperlinks does not constitute an endorsement or an approval by Vishay of any of the products, services or opinions of the corporation, organization or individual associated with the third-party website. Vishay disclaims any and all liability and bears no responsibility for the accuracy, legality or content of the third-party website or for that of subsequent links.

Except as expressly indicated in writing, Vishay products are not designed for use in medical, life-saving, or life-sustaining applications or for any other application in which the failure of the Vishay product could result in personal injury or death. Customers using or selling Vishay products not expressly indicated for use in such applications do so at their own risk. Please contact authorized Vishay personnel to obtain written terms and conditions regarding products designed for such applications.

No license, express or implied, by estoppel or otherwise, to any intellectual property rights is granted by this document or by any conduct of Vishay. Product names and markings noted herein may be trademarks of their respective owners.