

Hyperfast Rectifier, 3 A FRED Pt[®]

SMA (DO-214AC)

LINKS TO ADDITIONAL RESOURCES

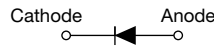

PRIMARY CHARACTERISTICS	
$I_{F(AV)}$	3 A
V_R	600 V
V_F at I_F	1.2 V
t_{rr} typ.	35 ns
T_J max.	175 °C
Package	SMA (DO-214AC)
Circuit configuration	Single

FEATURES

- Hyperfast recovery time, reduced Q_{rr} and soft recovery
- 175 °C maximum operating junction temperature
- For PFC CRM/CCM, snubber operation
- Low forward voltage drop
- Low leakage current
- Meets MSL level 1, per J-STD-020, LF maximum peak of 260 °C
- Designed and qualified according to JEDEC[®]-JESD 47
- Material categorization: for definitions of compliance please see www.vishay.com/doc?99912

RoHS
COMPLIANT
HALOGEN
FREE

DESCRIPTION / APPLICATIONS

State of the art hyperfast recovery rectifiers designed with optimized performance of forward voltage drop, hyperfast recovery time, and soft recovery.

The planar structure and the platinum doped life time control guarantee the best overall performance, ruggedness and reliability characteristics.

These devices are intended for use in PFC Boost stage in the AC/DC section of SMPS, inverters or as freewheeling diodes.

Their extremely optimized stored charge and low recovery current minimize the switching losses and reduce power dissipation in the switching element and snubbers.

MECHANICAL DATA

Case: SMA (DO-214AC)

Molding compound meets UL 94 V-0 flammability rating
Halogen-free, RoHS-compliant

Terminals: matte tin plated leads, solderable per J-STD-002

Polarity: color band denotes cathode end

ABSOLUTE MAXIMUM RATINGS				
PARAMETER	SYMBOL	TEST CONDITIONS	VALUES	UNITS
Peak repetitive reverse voltage	V_{RRM}		600	V
Average rectified forward current	$I_{F(AV)}$	$T_L = 81\text{ °C}$ ⁽¹⁾	3	A
Non-repetitive peak surge current	I_{FSM}	$T_J = 25\text{ °C}$, 6 ms square pulse	50	
Operating junction and storage temperatures	T_J, T_{Stg}		-55 to +175	°C

Note

⁽¹⁾ Mounted on PCB with minimum pad size

ELECTRICAL SPECIFICATIONS ($T_J = 25\text{ °C}$ unless otherwise specified)						
PARAMETER	SYMBOL	TEST CONDITIONS	MIN.	TYP.	MAX.	UNITS
Breakdown voltage, blocking voltage	V_{BR}, V_R	$I_R = 100\text{ }\mu\text{A}$	600	-	-	V
Forward voltage	V_F	$I_F = 3\text{ A}$ $I_F = 3\text{ A}, T_J = 150\text{ °C}$	-	1.4 1.20	1.7 1.35	
Reverse leakage current	I_R	$V_R = V_R$ rated $T_J = 150\text{ °C}, V_R = V_R$ rated	-	-	3 100	μA
Junction capacitance	C_T	$V_R = 600\text{ V}$	-	3.7	-	pF

DYNAMIC RECOVERY CHARACTERISTICS ($T_J = 25\text{ }^\circ\text{C}$ unless otherwise specified)						
PARAMETER	SYMBOL	TEST CONDITIONS	MIN.	TYP.	MAX.	UNITS
Reverse recovery time	t_{rr}	$I_F = 1.0\text{ A}$, $di_F/dt = 100\text{ A}/\mu\text{s}$, $V_R = 30\text{ V}$	-	35	-	ns
		$I_F = 1.0\text{ A}$, $di_F/dt = 50\text{ A}/\mu\text{s}$, $V_R = 30\text{ V}$	-	40	-	
		$I_F = 0.5\text{ A}$, $I_R = 1\text{ A}$, $I_{rr} = 0.25\text{ A}$	-	-	45	
		$T_J = 25\text{ }^\circ\text{C}$	-	25	-	
		$T_J = 125\text{ }^\circ\text{C}$	-	36	-	
Peak recovery current	I_{RRM}	$T_J = 25\text{ }^\circ\text{C}$	-	3.9	-	A
		$T_J = 125\text{ }^\circ\text{C}$	-	5.3	-	
Reverse recovery charge	Q_{rr}	$T_J = 25\text{ }^\circ\text{C}$	-	50	-	nC
		$T_J = 125\text{ }^\circ\text{C}$	-	98	-	

THERMAL - MECHANICAL SPECIFICATIONS						
PARAMETER	SYMBOL	TEST CONDITIONS	MIN.	TYP.	MAX.	UNITS
Maximum junction and storage temperature range	T_J, T_{Stg}		-55	-	175	$^\circ\text{C}$
Thermal resistance, junction to mount	$R_{thJM}^{(1)}$		-	-	20	$^\circ\text{C}/\text{W}$
Thermal resistance, junction to ambient	$R_{thJA}^{(1)}$		-	-	95	
Approximate Weight			0.07			g
			0.002			oz.
Marking device		Case style SMA (DO-214AC)	3H6			

Note

(1) Mounted on PCB with minimum pad size

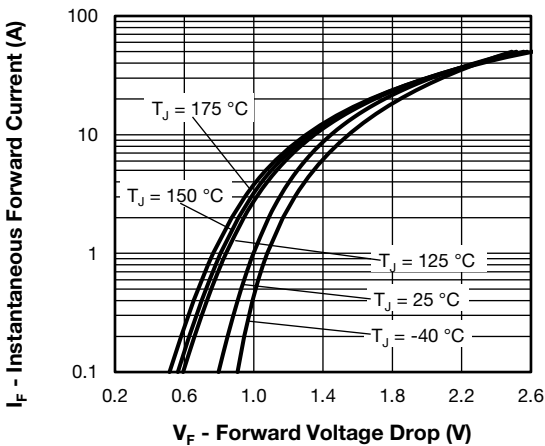

Fig. 1 - Typical Forward Voltage Drop Characteristics

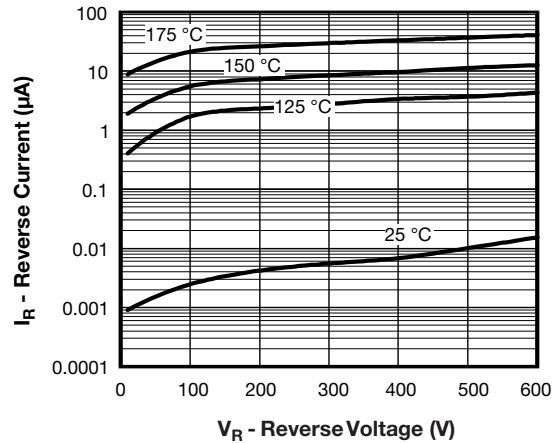

Fig. 2 - Typical Values of Reverse Current vs. Reverse Voltage

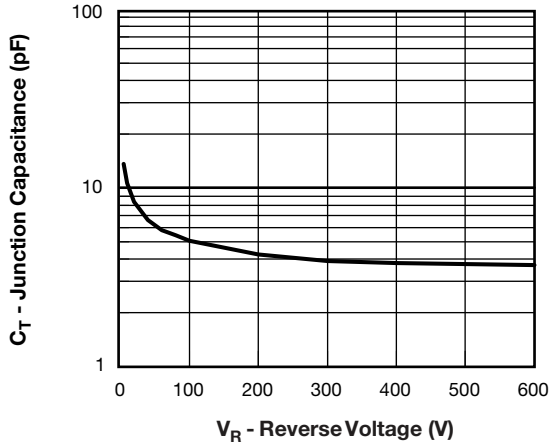

Fig. 3 - Typical Junction Capacitance vs. Reverse Voltage

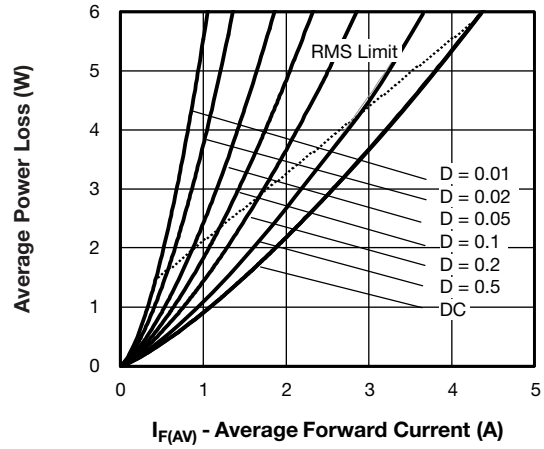

Fig. 5 - Forward Power Loss Characteristics

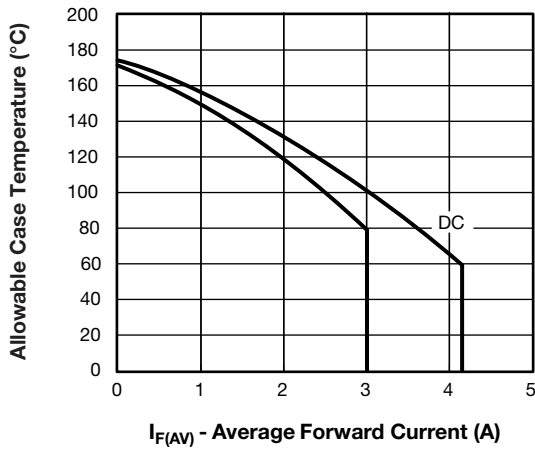

Fig. 4 - Maximum Allowable Case Temperature vs. Average Forward Current

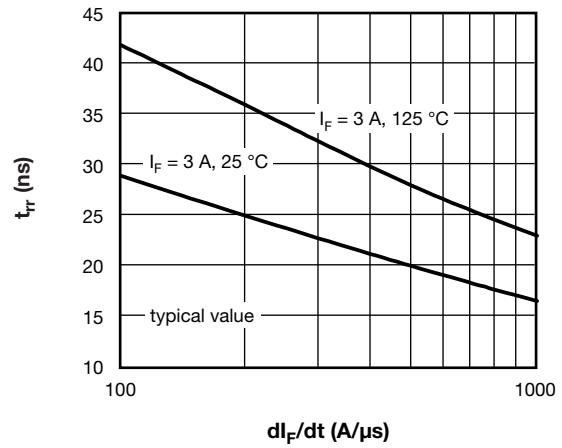

Fig. 6 - Typical Reverse Recovery vs. di_F/dt

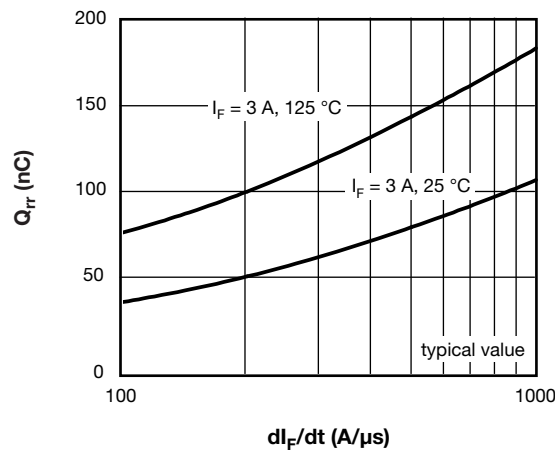
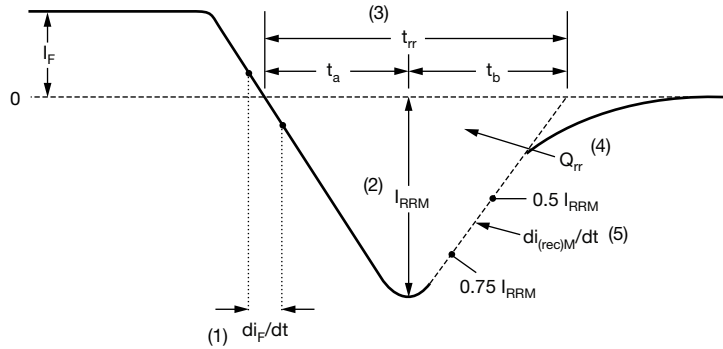

Fig. 7 - Typical Stored Charge vs. di_F/dt



- (1) di_F/dt - rate of change of current through zero crossing
- (2) I_{RRM} - peak reverse recovery current
- (3) t_{rr} - reverse recovery time measured from zero crossing point of negative going I_F to point where a line passing through $0.75 I_{RRM}$ and $0.50 I_{RRM}$ extrapolated to zero current.
- (4) Q_{rr} - area under curve defined by t_{rr} and I_{RRM}
- (5) $di_{(rec)M}/dt$ - peak rate of change of current during t_b portion of t_{rr}

$$Q_{rr} = \frac{t_{rr} \times I_{RRM}}{2}$$

Fig. 8 - Reverse Recovery Waveform and Definitions

ORDERING INFORMATION TABLE

Device code	VS-	3	E	M	H	06	-M3
	1	2	3	4	5	6	7

- 1** - Vishay Semiconductors product
- 2** - Current rating (3 = 3 A)
- 3** - Circuit configuration:
E = Single diode
- 4** - M = SMA package
- 5** - Process type,
H = Hyperfast recovery
- 6** - Voltage code (06 = 600 V)
- 7** - M3 = Halogen-free, RoHS-compliant, and totally lead (Pb)-free

ORDERING INFORMATION (Example)			
PREFERRED P/N	QUANTITY PER REEL	MINIMUM ORDER QUANTITY	PACKAGING DESCRIPTION
VS-3EMH06-M3/5AT	7500	7500	13" diameter plastic tape and reel

LINKS TO RELATED DOCUMENTS	
Dimensions	www.vishay.com/doc?95400
Part marking information	www.vishay.com/doc?95472
Packaging information	www.vishay.com/doc?95404

SMA

DIMENSIONS in inches (millimeters)

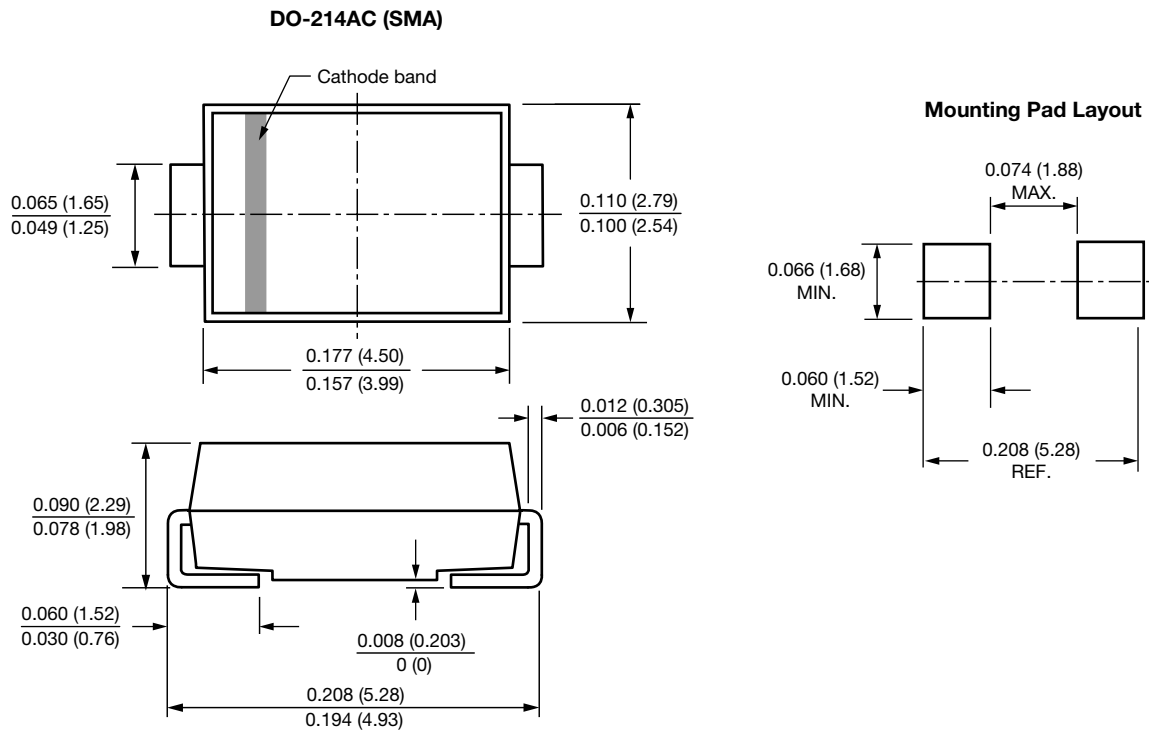



Disclaimer

ALL PRODUCT, PRODUCT SPECIFICATIONS AND DATA ARE SUBJECT TO CHANGE WITHOUT NOTICE TO IMPROVE RELIABILITY, FUNCTION OR DESIGN OR OTHERWISE.

Vishay Intertechnology, Inc., its affiliates, agents, and employees, and all persons acting on its or their behalf (collectively, "Vishay"), disclaim any and all liability for any errors, inaccuracies or incompleteness contained in any datasheet or in any other disclosure relating to any product.

Vishay makes no warranty, representation or guarantee regarding the suitability of the products for any particular purpose or the continuing production of any product. To the maximum extent permitted by applicable law, Vishay disclaims (i) any and all liability arising out of the application or use of any product, (ii) any and all liability, including without limitation special, consequential or incidental damages, and (iii) any and all implied warranties, including warranties of fitness for particular purpose, non-infringement and merchantability.

Statements regarding the suitability of products for certain types of applications are based on Vishay's knowledge of typical requirements that are often placed on Vishay products in generic applications. Such statements are not binding statements about the suitability of products for a particular application. It is the customer's responsibility to validate that a particular product with the properties described in the product specification is suitable for use in a particular application. Parameters provided in datasheets and / or specifications may vary in different applications and performance may vary over time. All operating parameters, including typical parameters, must be validated for each customer application by the customer's technical experts. Product specifications do not expand or otherwise modify Vishay's terms and conditions of purchase, including but not limited to the warranty expressed therein.

Hyperlinks included in this datasheet may direct users to third-party websites. These links are provided as a convenience and for informational purposes only. Inclusion of these hyperlinks does not constitute an endorsement or an approval by Vishay of any of the products, services or opinions of the corporation, organization or individual associated with the third-party website. Vishay disclaims any and all liability and bears no responsibility for the accuracy, legality or content of the third-party website or for that of subsequent links.

Except as expressly indicated in writing, Vishay products are not designed for use in medical, life-saving, or life-sustaining applications or for any other application in which the failure of the Vishay product could result in personal injury or death. Customers using or selling Vishay products not expressly indicated for use in such applications do so at their own risk. Please contact authorized Vishay personnel to obtain written terms and conditions regarding products designed for such applications.

No license, express or implied, by estoppel or otherwise, to any intellectual property rights is granted by this document or by any conduct of Vishay. Product names and markings noted herein may be trademarks of their respective owners.