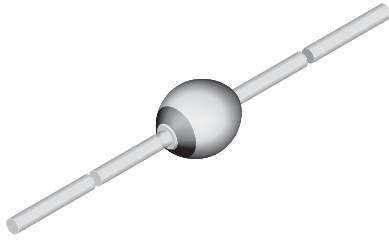




Ultra-Fast Avalanche Sinterglass Diode



949539

FEATURES

- Controlled avalanche characteristic
- Low forward voltage
- Ultra fast recovery time
- Glass passivated junction
- Hermetically sealed package
- Material categorization:
For definitions of compliance please see www.vishay.com/doc?99912



RoHS COMPLIANT HALOGEN FREE

MECHANICAL DATA

Case: SOD-57

Terminals: plated axial leads, solderable per MIL-STD-750, method 2026

Polarity: color band denotes cathode end

Mounting position: any

Weight: approx. 369 mg

APPLICATIONS

- Very fast rectification diode e.g. for switch mode power supply

ORDERING INFORMATION (Example)			
DEVICE NAME	ORDERING CODE	TAPED UNITS	MINIMUM ORDER QUANTITY
BYV27-200	BYV27-200-TR	5000 per 10" tape and reel	25 000
BYV27-200	BYV27-200-TAP	5000 per ammpack	25 000

PARTS TABLE		
PART	TYPE DIFFERENTIATION	PACKAGE
BYV27-50	$V_R = 50\text{ V}; I_{F(AV)} = 2\text{ A}$	SOD-57
BYV27-100	$V_R = 100\text{ V}; I_{F(AV)} = 2\text{ A}$	SOD-57
BYV27-150	$V_R = 150\text{ V}; I_{F(AV)} = 2\text{ A}$	SOD-57
BYV27-200	$V_R = 200\text{ V}; I_{F(AV)} = 2\text{ A}$	SOD-57

ABSOLUTE MAXIMUM RATINGS ($T_{amb} = 25\text{ }^\circ\text{C}$, unless otherwise specified)					
PARAMETER	TEST CONDITION	PART	SYMBOL	VALUE	UNIT
Peak reverse voltage, non repetitive	See electrical characteristics	BYV27-50	V_{RSM}	55	V
		BYV27-100	V_{RSM}	110	V
		BYV27-150	V_{RSM}	165	V
		BYV27-200	V_{RSM}	220	V
Reverse voltage = repetitive peak reverse voltage	See electrical characteristics	BYV27-50	$V_R = V_{RRM}$	50	V
		BYV27-100	$V_R = V_{RRM}$	100	V
		BYV27-150	$V_R = V_{RRM}$	150	V
		BYV27-200	$V_R = V_{RRM}$	200	V
Peak forward surge current	$t_p = 10\text{ ms}$, half sine wave		I_{FSM}	50	A
Repetitive peak forward current			I_{FRM}	15	A
Average forward current			$I_{F(AV)}$	2	A
Pulse energy in avalanche mode, non repetitive (inductive load switch off)	$I_{(BR)R} = 1\text{ A}$, $T_j = 175\text{ }^\circ\text{C}$		E_R	20	mJ
Junction and storage temperature range			$T_j = T_{stg}$	- 55 to + 175	$^\circ\text{C}$

MAXIMUM THERMAL RESISTANCE ($T_{amb} = 25\text{ }^\circ\text{C}$, unless otherwise specified)				
PARAMETER	TEST CONDITION	SYMBOL	VALUE	UNIT
Junction ambient	$l = 10\text{ mm}$, $T_L = \text{constant}$	R_{thJA}	45	K/W
	On PC board with spacing 25 mm	R_{thJA}	100	K/W

ELECTRICAL CHARACTERISTICS ($T_{amb} = 25\text{ }^{\circ}\text{C}$, unless otherwise specified)							
PARAMETER	TEST CONDITION	PART	SYMBOL	MIN.	TYP.	MAX.	UNIT
Forward voltage	$I_F = 3\text{ A}$		V_F	-	-	1.07	V
	$I_F = 3\text{ A}, T_j = 175\text{ }^{\circ}\text{C}$		V_F	-	-	0.88	V
Reverse current	$V_R = V_{RRM}$		I_R	-	-	1	μA
	V_{RSM}		I_R	-	-	100	μA
Reverse recovery time	$V_R = V_{RRM}, T_j = 165\text{ }^{\circ}\text{C}$		I_R	-	-	150	μA
	$I_F = 0.5\text{ A}, I_R = 1\text{ A}, t_R = 0.25\text{ A}$		t_{rr}	-	-	25	ns

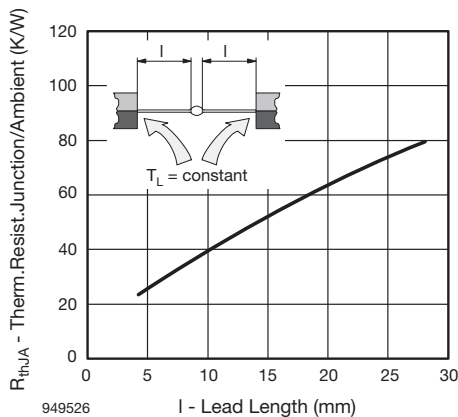
TYPICAL CHARACTERISTICS ($T_{amb} = 25\text{ }^{\circ}\text{C}$, unless otherwise specified)


Fig. 1 - Typ. Thermal Resistance vs. Lead Length

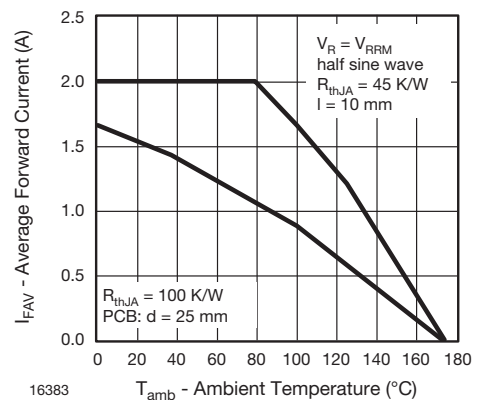


Fig. 3 - Max. Average Forward Current vs. Ambient Temperature

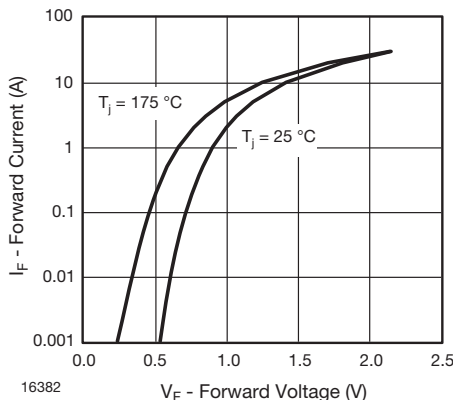


Fig. 2 - Forward Current vs. Forward Voltage

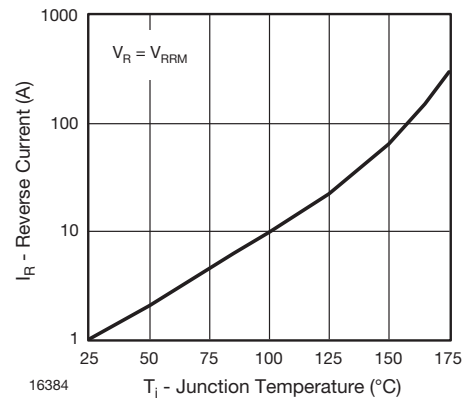


Fig. 4 - Reverse Current vs. Junction Temperature

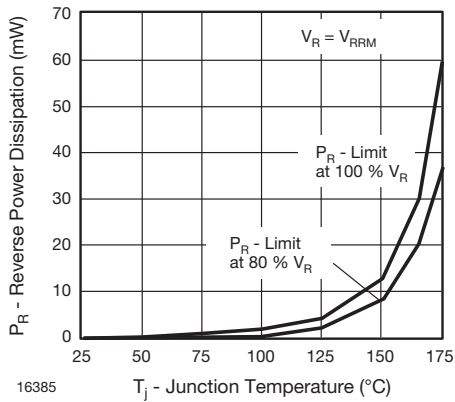


Fig. 5 - Max. Reverse Power Dissipation vs. Junction Temperature

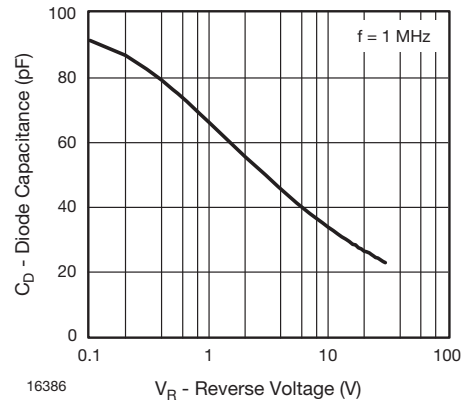
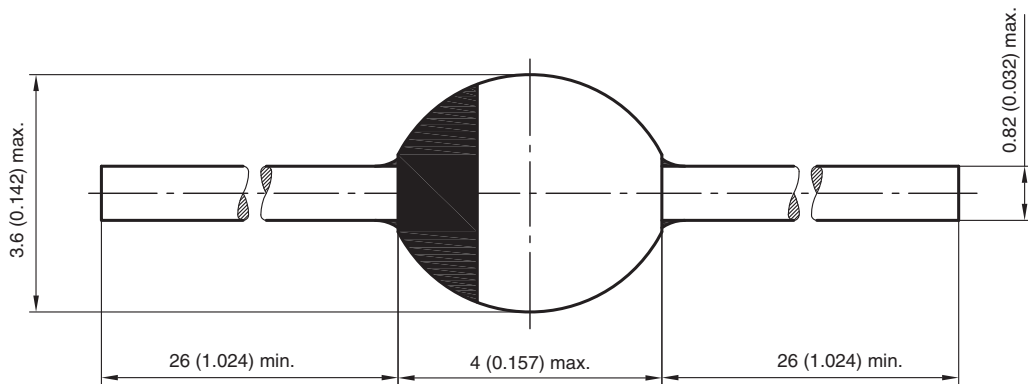


Fig. 6 - Diode Capacitance vs. Reverse Voltage

PACKAGE DIMENSIONS in millimeters (inches): **SOD-57**



20543
 Rev. 3 - Date: 09.February 2005
 Document no.:6.563-5006.3-4



Disclaimer

ALL PRODUCT, PRODUCT SPECIFICATIONS AND DATA ARE SUBJECT TO CHANGE WITHOUT NOTICE TO IMPROVE RELIABILITY, FUNCTION OR DESIGN OR OTHERWISE.

Vishay Intertechnology, Inc., its affiliates, agents, and employees, and all persons acting on its or their behalf (collectively, "Vishay"), disclaim any and all liability for any errors, inaccuracies or incompleteness contained in any datasheet or in any other disclosure relating to any product.

Vishay makes no warranty, representation or guarantee regarding the suitability of the products for any particular purpose or the continuing production of any product. To the maximum extent permitted by applicable law, Vishay disclaims (i) any and all liability arising out of the application or use of any product, (ii) any and all liability, including without limitation special, consequential or incidental damages, and (iii) any and all implied warranties, including warranties of fitness for particular purpose, non-infringement and merchantability.

Statements regarding the suitability of products for certain types of applications are based on Vishay's knowledge of typical requirements that are often placed on Vishay products in generic applications. Such statements are not binding statements about the suitability of products for a particular application. It is the customer's responsibility to validate that a particular product with the properties described in the product specification is suitable for use in a particular application. Parameters provided in datasheets and / or specifications may vary in different applications and performance may vary over time. All operating parameters, including typical parameters, must be validated for each customer application by the customer's technical experts. Product specifications do not expand or otherwise modify Vishay's terms and conditions of purchase, including but not limited to the warranty expressed therein.

Hyperlinks included in this datasheet may direct users to third-party websites. These links are provided as a convenience and for informational purposes only. Inclusion of these hyperlinks does not constitute an endorsement or an approval by Vishay of any of the products, services or opinions of the corporation, organization or individual associated with the third-party website. Vishay disclaims any and all liability and bears no responsibility for the accuracy, legality or content of the third-party website or for that of subsequent links.

Except as expressly indicated in writing, Vishay products are not designed for use in medical, life-saving, or life-sustaining applications or for any other application in which the failure of the Vishay product could result in personal injury or death. Customers using or selling Vishay products not expressly indicated for use in such applications do so at their own risk. Please contact authorized Vishay personnel to obtain written terms and conditions regarding products designed for such applications.

No license, express or implied, by estoppel or otherwise, to any intellectual property rights is granted by this document or by any conduct of Vishay. Product names and markings noted herein may be trademarks of their respective owners.