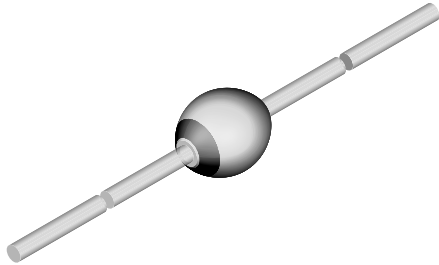




Fast Avalanche Sinterglass Diode



949539

FEATURES

- Glass passivated junction
- Hermetically sealed package
- Low reverse current
- Soft recovery characteristics
- Material categorization:
For definitions of compliance please see www.vishay.com/doc?99912



RoHS
COMPLIANT
HALOGEN
FREE

APPLICATIONS

- Fast rectification an switching diode for example for TV-line output circuits and switch mode power supply

MECHANICAL DATA

Case: SOD-57

Terminals: plated axial leads, solderable per MIL-STD-750, method 2026

Polarity: color band denotes cathode end

Mounting position: any

Weight: approx. 369 mg

| ORDERING INFORMATION (Example) | | | |
|--------------------------------|---------------|----------------------------|------------------------|
| DEVICE NAME | ORDERING CODE | TAPED UNITS | MINIMUM ORDER QUANTITY |
| BYW36 | BYW36-TR | 5000 per 10" tape and reel | 25 000 |
| BYW36 | BYW36-TAP | 5000 per ammpack | 25 000 |

| PARTS TABLE | | |
|-------------|--|---------|
| PART | TYPE DIFFERENTIATION | PACKAGE |
| BYW32 | $V_R = 200\text{ V}; I_{F(AV)} = 2\text{ A}$ | SOD-57 |
| BYW33 | $V_R = 300\text{ V}; I_{F(AV)} = 2\text{ A}$ | SOD-57 |
| BYW34 | $V_R = 400\text{ V}; I_{F(AV)} = 2\text{ A}$ | SOD-57 |
| BYW35 | $V_R = 500\text{ V}; I_{F(AV)} = 2\text{ A}$ | SOD-57 |
| BYW36 | $V_R = 600\text{ V}; I_{F(AV)} = 2\text{ A}$ | SOD-57 |

| ABSOLUTE MAXIMUM RATINGS ($T_{amb} = 25\text{ }^\circ\text{C}$, unless otherwise specified) | | | | | |
|---|---------------------------------------|-------|-----------------|---------------|------------------|
| PARAMETER | TEST CONDITION | PART | SYMBOL | VALUE | UNIT |
| Reverse voltage = repetitive peak reverse voltage | See electrical characteristics | BYW32 | $V_R = V_{RRM}$ | 200 | V |
| | | BYW33 | $V_R = V_{RRM}$ | 300 | V |
| | | BYW34 | $V_R = V_{RRM}$ | 400 | V |
| | | BYW35 | $V_R = V_{RRM}$ | 500 | V |
| | | BYW36 | $V_R = V_{RRM}$ | 600 | V |
| Peak forward surge current | $t_p = 10\text{ ms}$, half sine wave | | I_{FSM} | 50 | A |
| Repetitive peak forward current | | | I_{FRM} | 12 | A |
| Average forward current | $\varphi = 180^\circ$ | | $I_{F(AV)}$ | 2 | A |
| Non repetitive reverse avalanche energy | $I_{(BR)R} = 0.4\text{ A}$ | | E_R | 10 | mJ |
| Junction and storage temperature range | | | $T_j = T_{stg}$ | - 55 to + 175 | $^\circ\text{C}$ |

| MAXIMUM THERMAL RESISTANCE ($T_{amb} = 25\text{ }^{\circ}\text{C}$, unless otherwise specified) | | | | |
|---|--|------------|-------|------|
| PARAMETER | TEST CONDITION | SYMBOL | VALUE | UNIT |
| Junction ambient | Lead length $l = 10\text{ mm}$, $T_L = \text{constant}$ | R_{thJA} | 45 | K/W |
| | On PC board with spacing 25 mm | R_{thJA} | 100 | K/W |

| ELECTRICAL CHARACTERISTICS ($T_{amb} = 25\text{ }^{\circ}\text{C}$, unless otherwise specified) | | | | | | | |
|---|---|------|----------|------|------|------|---------------|
| PARAMETER | TEST CONDITION | PART | SYMBOL | MIN. | TYP. | MAX. | UNIT |
| Forward voltage | $I_F = 1\text{ A}$ | | V_F | - | 0.95 | 1.1 | V |
| Reverse current | $V_R = V_{RRM}$ | | I_R | - | 1 | 5 | μA |
| | $V_R = V_{RRM}$, $T_j = 150\text{ }^{\circ}\text{C}$ | | I_R | - | 60 | 150 | μA |
| Reverse recovery time | $I_F = 0.5\text{ A}$, $I_R = 1\text{ A}$, $i_R = 0.25\text{ A}$ | | t_{rr} | - | - | 200 | ns |

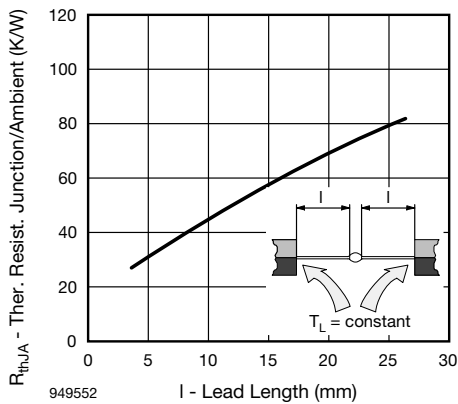
TYPICAL CHARACTERISTICS ($T_{amb} = 25\text{ }^{\circ}\text{C}$, unless otherwise specified)


Fig. 1 - Max. Thermal Resistance vs. Lead Length

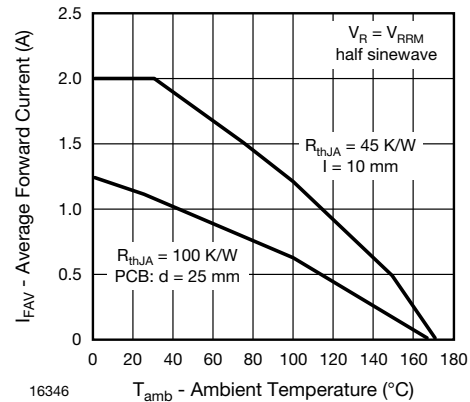


Fig. 3 - Max. Average Forward Current vs. Ambient Temperature

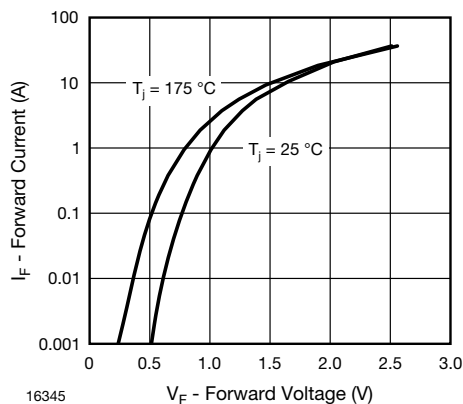
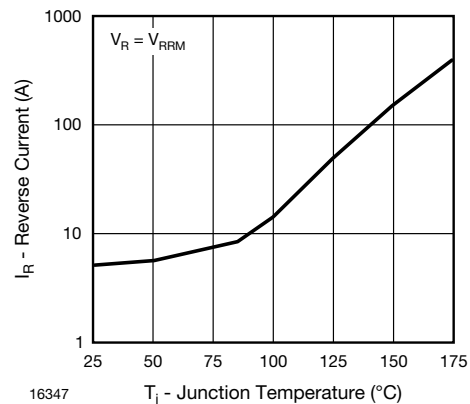


Fig. 2 - Forward Current vs. Forward Voltage


 Fig. 4 - Reverse Current vs. Junction Temperature ($^{\circ}\text{C}$)

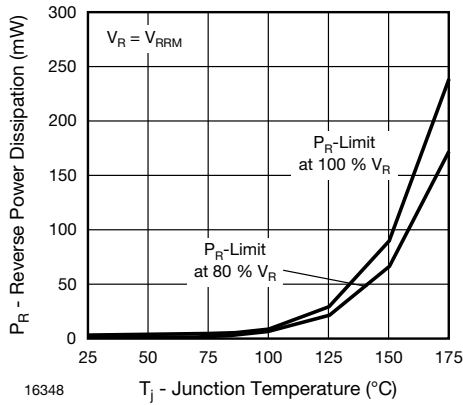


Fig. 5 - Max. Reverse Power Dissipation vs. Junction Temperature

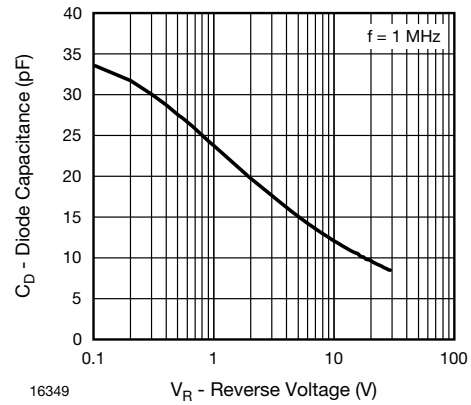


Fig. 6 - Diode Capacitance vs. Reverse Voltage

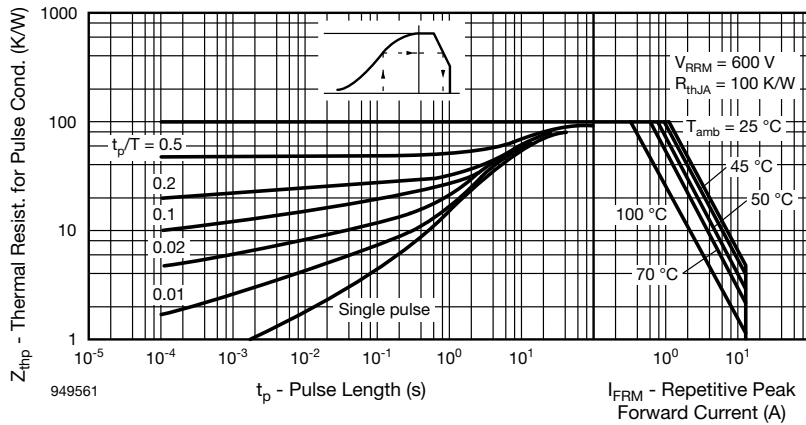
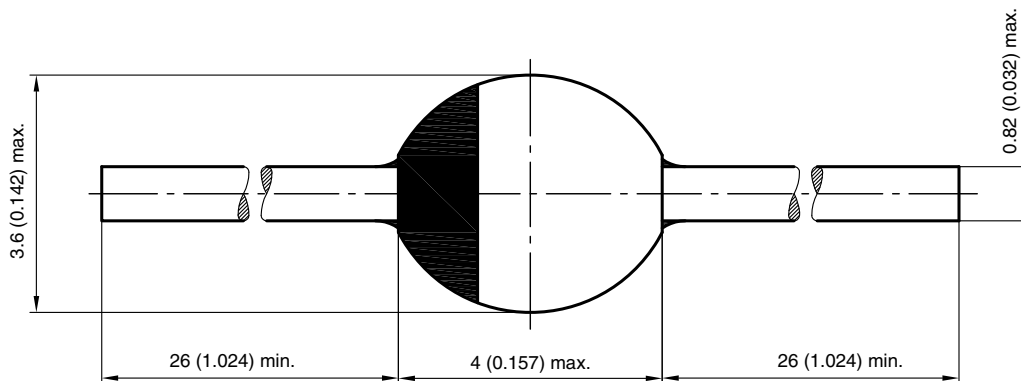


Fig. 7 - Thermal Response

PACKAGE DIMENSIONS in millimeters (inches): SOD-57



20543
Rev. 3 - Date: 09.February 2005
Document no.:6.563-5006.3-4



Disclaimer

ALL PRODUCT, PRODUCT SPECIFICATIONS AND DATA ARE SUBJECT TO CHANGE WITHOUT NOTICE TO IMPROVE RELIABILITY, FUNCTION OR DESIGN OR OTHERWISE.

Vishay Intertechnology, Inc., its affiliates, agents, and employees, and all persons acting on its or their behalf (collectively, "Vishay"), disclaim any and all liability for any errors, inaccuracies or incompleteness contained in any datasheet or in any other disclosure relating to any product.

Vishay makes no warranty, representation or guarantee regarding the suitability of the products for any particular purpose or the continuing production of any product. To the maximum extent permitted by applicable law, Vishay disclaims (i) any and all liability arising out of the application or use of any product, (ii) any and all liability, including without limitation special, consequential or incidental damages, and (iii) any and all implied warranties, including warranties of fitness for particular purpose, non-infringement and merchantability.

Statements regarding the suitability of products for certain types of applications are based on Vishay's knowledge of typical requirements that are often placed on Vishay products in generic applications. Such statements are not binding statements about the suitability of products for a particular application. It is the customer's responsibility to validate that a particular product with the properties described in the product specification is suitable for use in a particular application. Parameters provided in datasheets and / or specifications may vary in different applications and performance may vary over time. All operating parameters, including typical parameters, must be validated for each customer application by the customer's technical experts. Product specifications do not expand or otherwise modify Vishay's terms and conditions of purchase, including but not limited to the warranty expressed therein.

Hyperlinks included in this datasheet may direct users to third-party websites. These links are provided as a convenience and for informational purposes only. Inclusion of these hyperlinks does not constitute an endorsement or an approval by Vishay of any of the products, services or opinions of the corporation, organization or individual associated with the third-party website. Vishay disclaims any and all liability and bears no responsibility for the accuracy, legality or content of the third-party website or for that of subsequent links.

Except as expressly indicated in writing, Vishay products are not designed for use in medical, life-saving, or life-sustaining applications or for any other application in which the failure of the Vishay product could result in personal injury or death. Customers using or selling Vishay products not expressly indicated for use in such applications do so at their own risk. Please contact authorized Vishay personnel to obtain written terms and conditions regarding products designed for such applications.

No license, express or implied, by estoppel or otherwise, to any intellectual property rights is granted by this document or by any conduct of Vishay. Product names and markings noted herein may be trademarks of their respective owners.