

## Schottky Rectifier, 2 A

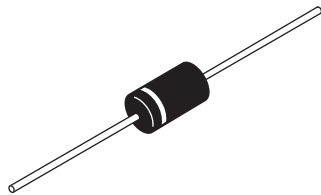

DO-204AL



### FEATURES

- Low profile, axial leaded outline
- High frequency operation
- Very low forward voltage drop
- High purity, high temperature epoxy encapsulation for enhanced mechanical strength and moisture resistance
- Guard ring for enhanced ruggedness and long term reliability
- Compliant to RoHS Directive 2002/95/EC
- Designed and qualified for commercial level
- Halogen-free according to IEC 61249-2-21 definition (-M3 only)



PRODUCT SUMMARY	
Package	DO-204AL (DO-41)
$I_{F(AV)}$	2 A
$V_R$	40 V
$V_F$ at $I_F$	0.5 V
$I_{RM}$ max.	10 mA at 125 °C
$T_J$ max.	150 °C
Diode variation	Single die
$E_{AS}$	5.0 mJ

### DESCRIPTION

The VS-21DQ04... axial leaded Schottky rectifier has been optimized for very low forward voltage drop, with moderate leakage. Typical applications are in switching power supplies, converters, freewheeling diodes, and reverse battery protection.

MAJOR RATINGS AND CHARACTERISTICS			
SYMBOL	CHARACTERISTICS	VALUES	UNITS
$I_{F(AV)}$	Rectangular waveform	2	A
$V_{RRM}$		40	V
$V_F$	2 Apk, $T_J = 125$ °C	0.5	
$T_J$	Range	- 40 to 150	°C

VOLTAGE RATINGS				
PARAMETER	SYMBOL	VS-21DQ04	VS-21DQ04-M3	UNITS
Maximum DC reverse voltage	$V_R$	40	40	V
Maximum working peak reverse voltage	$V_{RWM}$			

ABSOLUTE MAXIMUM RATINGS					
PARAMETER	SYMBOL	TEST CONDITIONS		VALUES	UNITS
Maximum average forward current See fig. 4	$I_{F(AV)}$	50 % duty cycle at $T_C = 112$ °C, rectangular waveform		2	A
Maximum peak one cycle non-repetitive surge current See fig. 6	$I_{FSM}$	5 $\mu$ s sine or 3 $\mu$ s rect. pulse	Following any rated load condition and with rated $V_{RRM}$ applied	420	
		10 ms sine or 6 ms rect. pulse		70	
Non-repetitive avalanche energy	$E_{AS}$	$T_J = 25$ °C, $I_{AS} = 1.0$ A, $L = 10$ mH		5.0	mJ
Repetitive avalanche current	$I_{AR}$	Current decaying linearly to zero in 1 $\mu$ s Frequency limited by $T_J$ maximum $V_A = 1.5 \times V_R$ typical		1.0	A



ELECTRICAL SPECIFICATIONS						
PARAMETER	SYMBOL	TEST CONDITIONS		VALUES		UNITS
				TYP.	MAX.	
Maximum forward voltage drop	$V_{FM}^{(1)}$	2 A	$T_J = 25\text{ }^\circ\text{C}$	0.49	0.55	V
		4 A		0.60	0.65	
		2 A	$T_J = 125\text{ }^\circ\text{C}$	0.42	0.5	
		4 A		0.56	0.62	
Maximum reverse leakage current	$I_{RM}^{(1)}$	$T_J = 25\text{ }^\circ\text{C}$	$V_R = \text{Rated } V_R$	0.01	0.50	mA
		$T_J = 125\text{ }^\circ\text{C}$		5.2	10	
Typical junction capacitance	$C_T$	$V_R = 5\text{ }V_{DC}$ (test signal range 100 kHz to 1 MHz) $25\text{ }^\circ\text{C}$		130		pF
Typical series inductance	$L_S$	Measured lead to lead 5 mm from package body		8.0		nH

**Note**(1) Pulse width < 300  $\mu\text{s}$ , duty cycle < 2 %

THERMAL - MECHANICAL SPECIFICATIONS				
PARAMETER	SYMBOL	TEST CONDITIONS	VALUES	UNITS
Maximum junction and storage temperature range	$T_J^{(1)}, T_{Stg}$		- 40 to 150	$^\circ\text{C}$
Maximum thermal resistance, junction to ambient	$R_{thJA}$	DC operation Without cooling fin	100	$^\circ\text{C/W}$
Typical thermal resistance, junction to lead	$R_{thJL}$	DC operation See fig. 4	25	
Approximate weight			0.33	g
			0.012	oz.
Marking device		Case style DO-204AL (D-41)	21DQ04	

**Note**(1)  $\frac{dP_{tot}}{dT_J} < \frac{1}{R_{thJA}}$  thermal runaway condition for a diode on its own heatsink

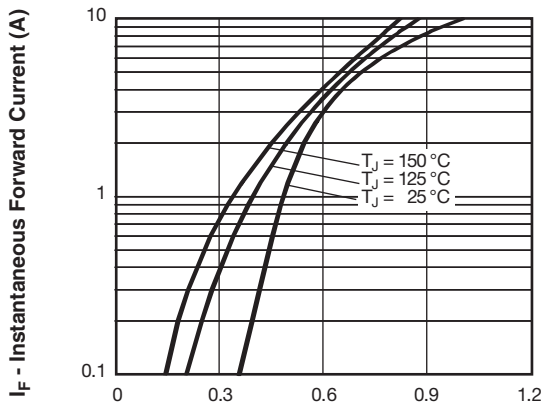

93279\_01 **V<sub>FM</sub> - Forward Voltage Drop (V)**  
Fig. 1 - Maximum Forward Voltage Drop Characteristics

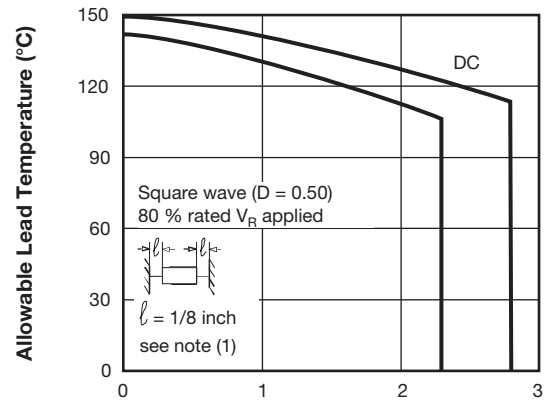

93279\_04 **I<sub>F(AV)</sub> - Average Forward Current (A)**  
Fig. 4 - Maximum Allowable Lead Temperature vs. Average Forward Current

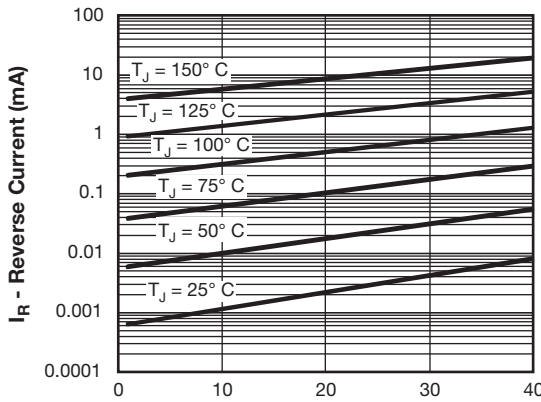

93279\_02 **V<sub>R</sub> - Reverse Voltage (V)**  
Fig. 2 - Typical Values of Reverse Current vs. Reverse Voltage

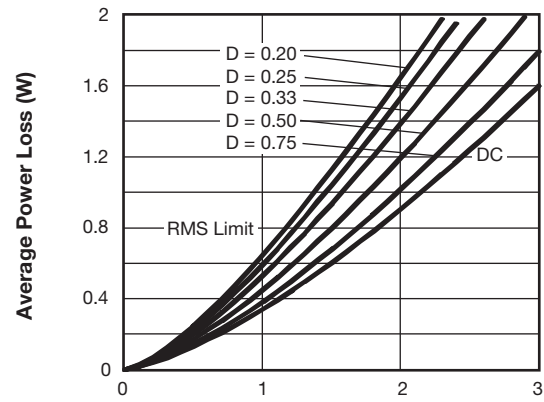

93279\_05 **Average Forward Current - I<sub>F(AV)</sub> (A)**  
Fig. 5 - Forward Power Loss Characteristics

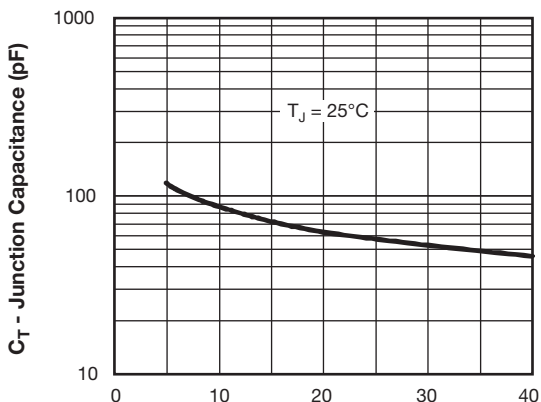

93279\_03 **V<sub>R</sub> - Reverse Voltage (V)**  
Fig. 3 - Typical Junction Capacitance vs. Reverse Voltage

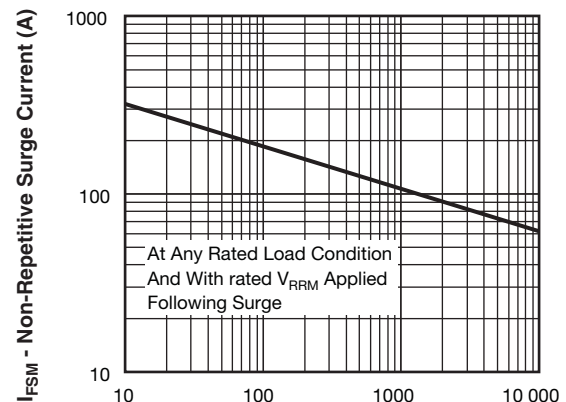

93279\_06 **t<sub>p</sub> - Square Wave Pulse Duration (µs)**  
Fig. 6 - Maximum Non-Repetitive Surge Current

**Note**

- (1) Formula used:  $T_C = T_J - (P_d + P_{d_{REV}}) \times R_{thJC}$ ;  
 $P_d = \text{Forward power loss} = I_{F(AV)} \times V_{FM}$  at  $(I_{F(AV)}/D)$  (see fig. 6);  $P_{d_{REV}} = \text{Inverse power loss} = V_{R1} \times I_R (1 - D)$ ;  $I_R$  at  $V_{R1} = 80\%$  rated  $V_R$



## ORDERING INFORMATION TABLE

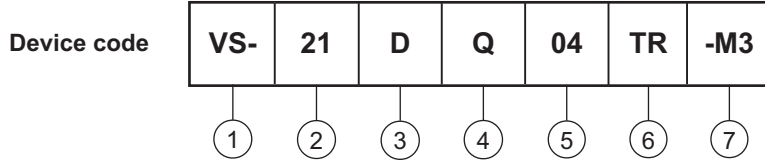

- 1** - Vishay Semiconductors product
- 2** - 21 = Current Rating 2 A
- 3** - D = DO-41 package
- 4** - Q = Schottky Q.. series
- 5** - 04 = Voltage rating: 40 V
- 6** - TR = Tape and reel package  
TB = Tape and ammo box package  
None = Bulk package
- 7** - Environmental digit
  - None = Lead (Pb)-free and RoHS compliant
  - -M3 = Halogen-free, RoHS compliant, and terminations lead (Pb)-free

ORDERING INFORMATION (Example)			
PREFERRED P/N	QUANTITY PER T/R	MINIMUM ORDER QUANTITY	PACKAGING DESCRIPTION
VS-21DQ04	1000	1000	Bulk
VS-21DQ04TR	5000	5000	Tape and Reel
VS-21DQ04TB	3000	3000	Tape and ammo box
VS-21DQ04-M3	1000	1000	Bulk
VS-21DQ04TR-M3	5000	5000	Tape and Reel
VS-21DQ04TB-M3	3000	3000	Tape and ammo box

LINKS TO RELATED DOCUMENTS	
Dimensions	<a href="http://www.vishay.com/doc?95241">www.vishay.com/doc?95241</a>
Part marking information	<a href="http://www.vishay.com/doc?95304">www.vishay.com/doc?95304</a>
Packaging information	<a href="http://www.vishay.com/doc?95338">www.vishay.com/doc?95338</a>



## Axial DO-204AL (DO-41)

**DIMENSIONS** in millimeters (inches)

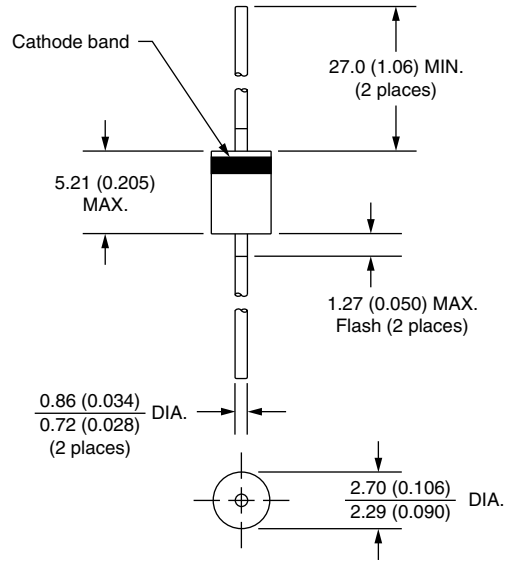



## Disclaimer

ALL PRODUCT, PRODUCT SPECIFICATIONS AND DATA ARE SUBJECT TO CHANGE WITHOUT NOTICE TO IMPROVE RELIABILITY, FUNCTION OR DESIGN OR OTHERWISE.

Vishay Intertechnology, Inc., its affiliates, agents, and employees, and all persons acting on its or their behalf (collectively, "Vishay"), disclaim any and all liability for any errors, inaccuracies or incompleteness contained in any datasheet or in any other disclosure relating to any product.

Vishay makes no warranty, representation or guarantee regarding the suitability of the products for any particular purpose or the continuing production of any product. To the maximum extent permitted by applicable law, Vishay disclaims (i) any and all liability arising out of the application or use of any product, (ii) any and all liability, including without limitation special, consequential or incidental damages, and (iii) any and all implied warranties, including warranties of fitness for particular purpose, non-infringement and merchantability.

Statements regarding the suitability of products for certain types of applications are based on Vishay's knowledge of typical requirements that are often placed on Vishay products in generic applications. Such statements are not binding statements about the suitability of products for a particular application. It is the customer's responsibility to validate that a particular product with the properties described in the product specification is suitable for use in a particular application. Parameters provided in datasheets and/or specifications may vary in different applications and performance may vary over time. All operating parameters, including typical parameters, must be validated for each customer application by the customer's technical experts. Product specifications do not expand or otherwise modify Vishay's terms and conditions of purchase, including but not limited to the warranty expressed therein.

Except as expressly indicated in writing, Vishay products are not designed for use in medical, life-saving, or life-sustaining applications or for any other application in which the failure of the Vishay product could result in personal injury or death. Customers using or selling Vishay products not expressly indicated for use in such applications do so at their own risk. Please contact authorized Vishay personnel to obtain written terms and conditions regarding products designed for such applications.

No license, express or implied, by estoppel or otherwise, to any intellectual property rights is granted by this document or by any conduct of Vishay. Product names and markings noted herein may be trademarks of their respective owners.

## Material Category Policy

**Vishay Intertechnology, Inc. hereby certifies that all its products that are identified as RoHS-Compliant fulfill the definitions and restrictions defined under Directive 2011/65/EU of The European Parliament and of the Council of June 8, 2011 on the restriction of the use of certain hazardous substances in electrical and electronic equipment (EEE) - recast, unless otherwise specified as non-compliant.**

**Please note that some Vishay documentation may still make reference to RoHS Directive 2002/95/EC. We confirm that all the products identified as being compliant to Directive 2002/95/EC conform to Directive 2011/65/EU.**

**Vishay Intertechnology, Inc. hereby certifies that all its products that are identified as Halogen-Free follow Halogen-Free requirements as per JEDEC JS709A standards. Please note that some Vishay documentation may still make reference to the IEC 61249-2-21 definition. We confirm that all the products identified as being compliant to IEC 61249-2-21 conform to JEDEC JS709A standards.**