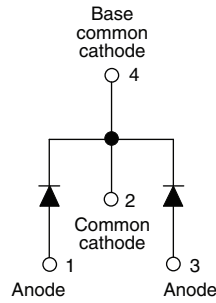

## High Performance Schottky Rectifier, 2 x 6 A

**D-PAK (TO-252AA)**

### FEATURES

- Popular D-PAK outline
- Center tap configuration
- Small foot print, surface mountable
- Low forward voltage drop
- High frequency operation
- Guard ring for enhanced ruggedness and long term reliability
- Meets MSL level 1, per J-STD-020, LF maximum peak of 260 °C
- Material categorization: for definitions of compliance please see [www.vishay.com/doc?99912](http://www.vishay.com/doc?99912)

**RoHS**  
COMPLIANT

PRODUCT SUMMARY	
Package	D-PAK (TO-252AA)
$I_{F(AV)}$	2 x 6 A
$V_R$	60 V
$V_F$ at $I_F$	0.57 V
$I_{RM}$	35 mA at 125 °C
$T_J$ max.	150 °C
Diode variation	Common cathode
$E_{AS}$	7 mJ

### DESCRIPTION

The VS-12CWQ06FNPbF surface mount, center tap, Schottky rectifier series has been designed for applications requiring low forward drop and small foot prints on PC board. Typical applications are in disk drives, switching power supplies, converters, freewheeling diodes, battery charging, and reverse battery protection.

MAJOR RATINGS AND CHARACTERISTICS			
SYMBOL	CHARACTERISTICS	VALUES	UNITS
$I_{F(AV)}$	Rectangular waveform	12	A
$V_{RRM}$		60	V
$I_{FSM}$	$t_p = 5 \mu s$ sine	320	A
$V_F$	6 $A_{pk}$ , $T_J = 125 \text{ }^\circ\text{C}$ (per leg)	0.57	V
$T_J$	Range	-55 to +150	°C

VOLTAGE RATINGS			
PARAMETER	SYMBOL	VS-12CWQ06FNPbF	UNITS
Maximum DC reverse voltage	$V_R$	60	V
Maximum working peak reverse voltage	$V_{RWM}$		

ABSOLUTE MAXIMUM RATINGS					
PARAMETER	SYMBOL	TEST CONDITIONS		VALUES	UNITS
Maximum average forward current See fig. 5	$I_{F(AV)}$	50 % duty cycle at $T_C = 131 \text{ }^\circ\text{C}$ , rectangular waveform	per leg	6	A
			per device	12	
Maximum peak one cycle non-repetitive surge current See fig. 7	$I_{FSM}$	5 $\mu s$ sine or 3 $\mu s$ rect. pulse 10 ms sine or 6 ms rect. pulse	Following any rated load condition and with rated $V_{RRM}$ applied	320	A
				105	
Non-repetitive avalanche energy per leg	$E_{AS}$	$T_J = 25 \text{ }^\circ\text{C}$ , $I_{AS} = 1.2 \text{ A}$ , $L = 10 \text{ mH}$		7	mJ
Repetitive avalanche current per leg	$I_{AR}$	Current decaying linearly to zero in 1 $\mu s$ Frequency limited by $T_J$ maximum $V_A = 1.5 \times V_R$ typical		0.8	A



ELECTRICAL SPECIFICATIONS					
PARAMETER	SYMBOL	TEST CONDITIONS		VALUES	UNITS
Maximum forward voltage drop per leg See fig. 1	$V_{FM}^{(1)}$	6 A	$T_J = 25\text{ }^\circ\text{C}$	0.61	V
		12 A		0.79	
		6 A	$T_J = 125\text{ }^\circ\text{C}$	0.57	
		12 A		0.72	
Maximum reverse leakage current per leg See fig. 2	$I_{RM}^{(1)}$	$T_J = 25\text{ }^\circ\text{C}$	$V_R = \text{Rated } V_R$	3	mA
		$T_J = 125\text{ }^\circ\text{C}$		35	
Threshold voltage	$V_{F(TO)}$	$T_J = T_J \text{ maximum}$		0.36	V
Forward slope resistance	$r_t$			24.14	m $\Omega$
Typical junction capacitance per leg	$C_T$	$V_R = 5 V_{DC}$ , (test signal range 100 kHz to 1 MHz), $25\text{ }^\circ\text{C}$		360	pF
Typical series inductance per leg	$L_S$	Measured lead to lead 5 mm from package body		5.0	nH

**Note**(1) Pulse width < 300  $\mu\text{s}$ , duty cycle < 2 %

THERMAL - MECHANICAL SPECIFICATIONS				
PARAMETER	SYMBOL	TEST CONDITIONS	VALUES	UNITS
Maximum junction and storage temperature range	$T_J^{(1)}$ , $T_{Stg}$		-55 to +150	$^\circ\text{C}$
Maximum thermal resistance, junction to case	$R_{thJC}$	DC operation See fig. 4	3.0	$^\circ\text{C/W}$
			1.5	
Approximate weight			0.3	g
			0.01	oz.
Marking device		Case style D-PAK (similar to TO-252AA)	12CWQ06FN	

**Note**(1)  $\frac{dP_{tot}}{dT_J} < \frac{1}{R_{thJA}}$  thermal runaway condition for a diode on its own heatsink

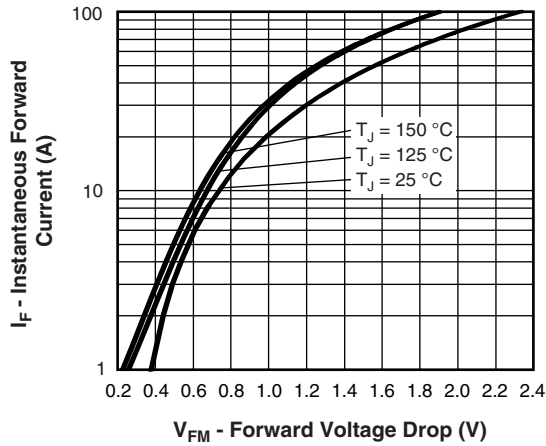

Fig. 1 - Maximum Forward Voltage Drop Characteristics (Per Leg)

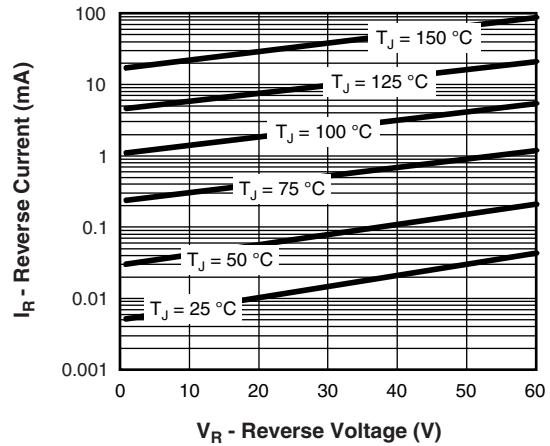

Fig. 2 - Typical Values of Reverse Current vs. Reverse Voltage (Per Leg)

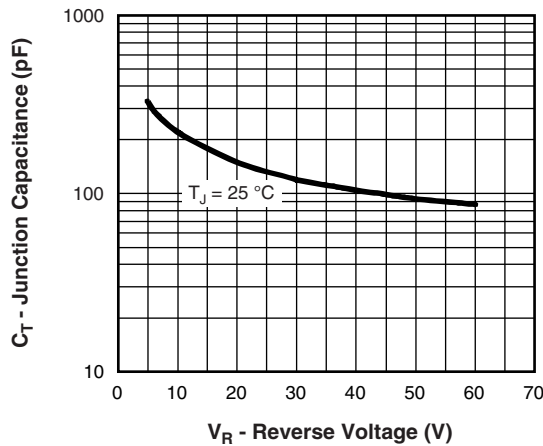

Fig. 3 - Typical Junction Capacitance vs. Reverse Voltage (Per Leg)

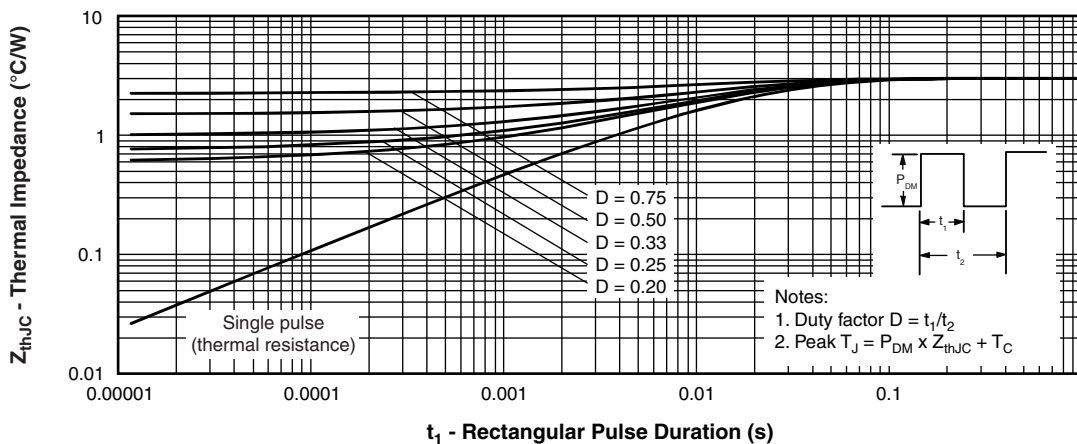

Fig. 4 - Maximum Thermal Impedance  $Z_{thJC}$  Characteristics (Per Leg)

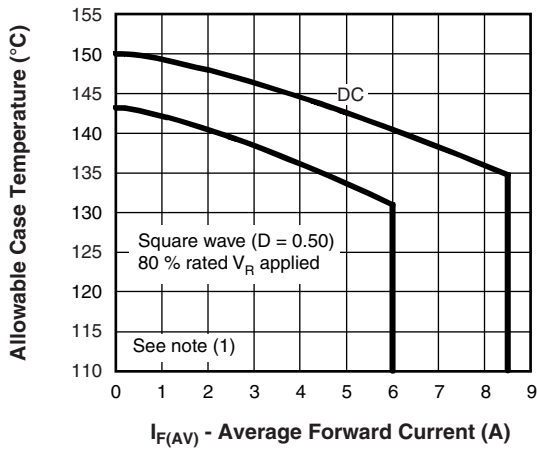

Fig. 5 - Maximum Allowable Case Temperature vs. Average Forward Current (Per Leg)

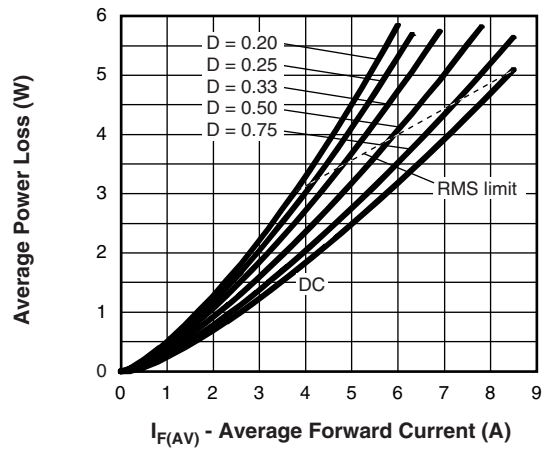

Fig. 6 - Forward Power Loss Characteristics (Per Leg)

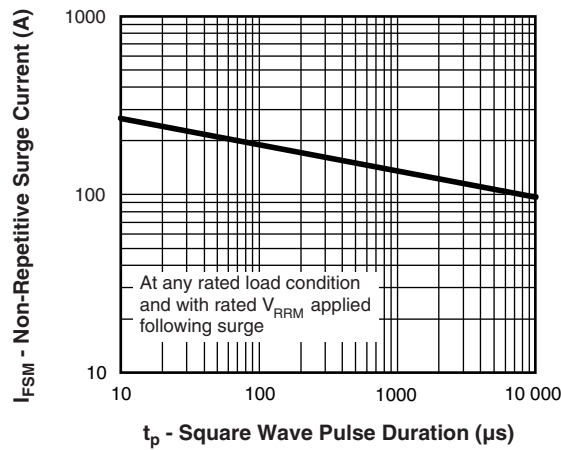

Fig. 7 - Maximum Non-Repetitive Surge Current (Per Leg)

**Note**

- (1) Formula used:  $T_C = T_J - (P_d + P_{d_{REV}}) \times R_{thJC}$ ;  
 $P_d$  = forward power loss =  $I_{F(AV)} \times V_{FM}$  at  $(I_{F(AV)}/D)$  (see fig. 6);  
 $P_{d_{REV}}$  = inverse power loss =  $V_{R1} \times I_R (1 - D)$ ;  $I_R$  at  $V_{R1} = 80\%$  rated  $V_R$



## ORDERING INFORMATION TABLE

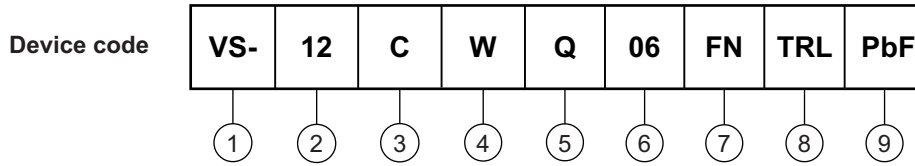

- 1** - Vishay Semiconductors product
- 2** - Current rating (12 A)
- 3** - Center tap configuration
- 4** - Package identifier:  
W = D-PAK
- 5** - Schottky "Q" series
- 6** - Voltage rating (06 = 60 V)
- 7** - FN = TO-252AA
- 8** -
  - None = tube (50 pieces)
  - TR = tape and reel
  - TRL = tape and reel (left oriented)
  - TRR = tape and reel (right oriented)
- 9** - PbF = lead (Pb)-free

LINKS TO RELATED DOCUMENTS	
Dimensions	<a href="http://www.vishay.com/doc?95016">www.vishay.com/doc?95016</a>
Part marking information	<a href="http://www.vishay.com/doc?95059">www.vishay.com/doc?95059</a>
Packaging information	<a href="http://www.vishay.com/doc?95033">www.vishay.com/doc?95033</a>
SPIICE model	<a href="http://www.vishay.com/doc?95278">www.vishay.com/doc?95278</a>

### D-PAK (TO-252AA)

**DIMENSIONS** in millimeters and inches

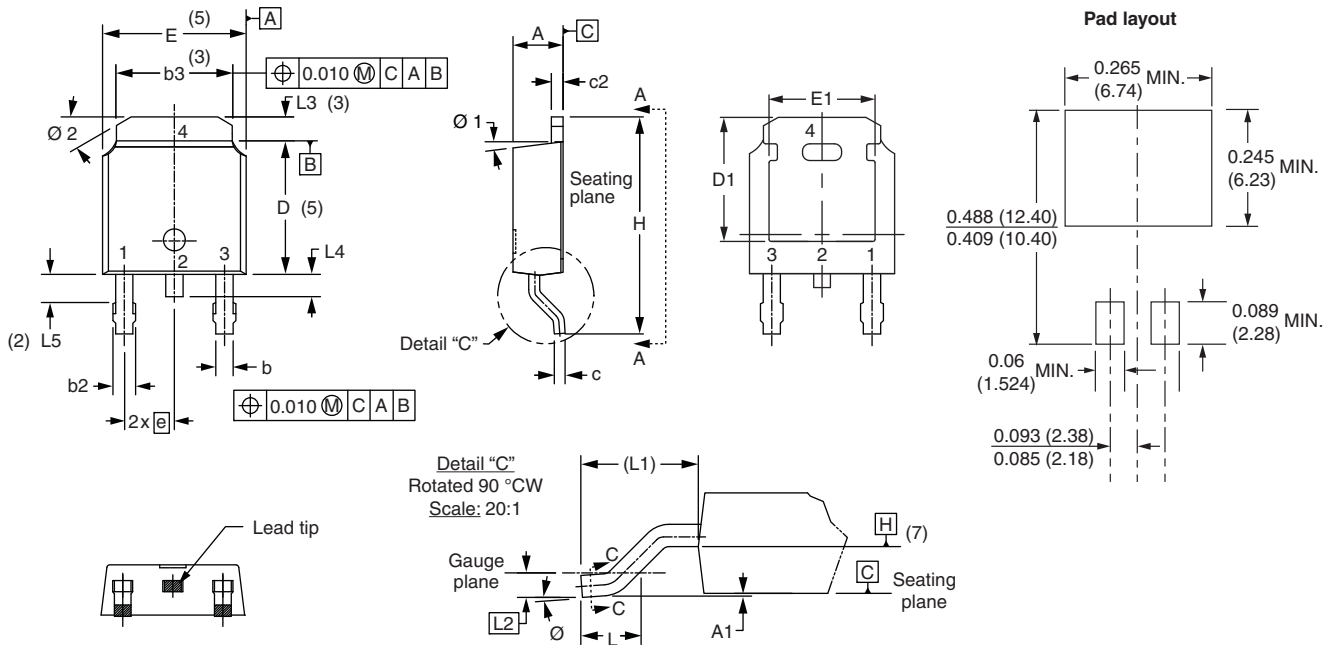

SYMBOL	MILLIMETERS		INCHES		NOTES	SYMBOL	MILLIMETERS		INCHES		NOTES
	MIN.	MAX.	MIN.	MAX.			MIN.	MAX.	MIN.	MAX.	
A	2.18	2.39	0.086	0.094		e	2.29 BSC		0.090 BSC		
A1	-	0.13	-	0.005		H	9.40	10.41	0.370	0.410	
b	0.64	0.89	0.025	0.035		L	1.40	1.78	0.055	0.070	
b2	0.76	1.14	0.030	0.045		L1	2.74 BSC		0.108 REF.		
b3	4.95	5.46	0.195	0.215	3	L2	0.51 BSC		0.020 BSC		
c	0.46	0.61	0.018	0.024		L3	0.89	1.27	0.035	0.050	3
c2	0.46	0.89	0.018	0.035		L4	-	1.02	-	0.040	
D	5.97	6.22	0.235	0.245	5	L5	1.14	1.52	0.045	0.060	2
D1	5.21	-	0.205	-	3	Ø	0°	10°	0°	10°	
E	6.35	6.73	0.250	0.265	5	Ø1	0°	15°	0°	15°	
E1	4.32	-	0.170	-	3	Ø2	25°	35°	25°	35°	

**Notes**

- (1) Dimensioning and tolerancing as per ASME Y14.5M-1994
- (2) Lead dimension uncontrolled in L5
- (3) Dimension D1, E1, L3 and b3 establish a minimum mounting surface for thermal pad
- (4) Section C - C dimension apply to the flat section of the lead between 0.13 and 0.25 mm (0.005 and 0.10") from the lead tip
- (5) Dimension D, and E do not include mold flash. Mold flash shall not exceed 0.127 mm (0.005") per side. These dimensions are measured at the outermost extremes of the plastic body
- (6) Dimension b1 and c1 applied to base metal only
- (7) Datum A and B to be determined at datum plane H
- (8) Outline conforms to JEDEC outline TO-252AA



## **Disclaimer**

ALL PRODUCT, PRODUCT SPECIFICATIONS AND DATA ARE SUBJECT TO CHANGE WITHOUT NOTICE TO IMPROVE RELIABILITY, FUNCTION OR DESIGN OR OTHERWISE.

Vishay Intertechnology, Inc., its affiliates, agents, and employees, and all persons acting on its or their behalf (collectively, "Vishay"), disclaim any and all liability for any errors, inaccuracies or incompleteness contained in any datasheet or in any other disclosure relating to any product.

Vishay makes no warranty, representation or guarantee regarding the suitability of the products for any particular purpose or the continuing production of any product. To the maximum extent permitted by applicable law, Vishay disclaims (i) any and all liability arising out of the application or use of any product, (ii) any and all liability, including without limitation special, consequential or incidental damages, and (iii) any and all implied warranties, including warranties of fitness for particular purpose, non-infringement and merchantability.

Statements regarding the suitability of products for certain types of applications are based on Vishay's knowledge of typical requirements that are often placed on Vishay products in generic applications. Such statements are not binding statements about the suitability of products for a particular application. It is the customer's responsibility to validate that a particular product with the properties described in the product specification is suitable for use in a particular application. Parameters provided in datasheets and / or specifications may vary in different applications and performance may vary over time. All operating parameters, including typical parameters, must be validated for each customer application by the customer's technical experts. Product specifications do not expand or otherwise modify Vishay's terms and conditions of purchase, including but not limited to the warranty expressed therein.

Except as expressly indicated in writing, Vishay products are not designed for use in medical, life-saving, or life-sustaining applications or for any other application in which the failure of the Vishay product could result in personal injury or death. Customers using or selling Vishay products not expressly indicated for use in such applications do so at their own risk. Please contact authorized Vishay personnel to obtain written terms and conditions regarding products designed for such applications.

No license, express or implied, by estoppel or otherwise, to any intellectual property rights is granted by this document or by any conduct of Vishay. Product names and markings noted herein may be trademarks of their respective owners.