

## Ultrafast Rectifier, 4 A FRED Pt®

**SMC (DO-214AB)**

### FEATURES

- Ultrafast recovery time, reduced  $Q_{rr}$  and soft recovery
- 175 °C maximum operating junction temperature
- For PFC CRM / CCM, snubber operation
- Low forward voltage drop
- Low leakage current
- Meets MSL level 1, per J-STD-020, LF maximum peak of 260 °C
- Designed and qualified according to JEDEC® JESD 47
- Material categorization: for definitions of compliance please see [www.vishay.com/doc?99912](http://www.vishay.com/doc?99912)

**RoHS**  
COMPLIANT  
HALOGEN  
**FREE**

### LINKS TO ADDITIONAL RESOURCES



3D Models

PRIMARY CHARACTERISTICS	
$I_{F(AV)}$	4 A
$V_R$	600 V
$V_F$ at $I_F$	0.88 V
$t_{rr}$ typ.	45 ns
$T_J$ max.	175 °C
Package	SMC (DO-214AB)
Circuit configuration	Single

### DESCRIPTION / APPLICATIONS

State of the art ultrafast recovery rectifiers designed with optimized performance of forward voltage drop, ultrafast recovery time, and soft recovery.

The planar structure and the platinum doped life time control guarantee the best overall performance, ruggedness and reliability characteristics.

These devices are intended for use in PFC boost stage in the AC/DC section of SMPS, inverters or as freewheeling diodes.

Their extremely optimized stored charge and low recovery current minimize the switching losses and reduce power dissipation in the switching element and snubbers.

### MECHANICAL DATA

**Case:** SMC (DO-214AB)

Molding compound meets UL 94 V-0 flammability rating  
Halogen-free, RoHS-compliant

**Terminals:** matte tin plated leads, solderable per J-STD-002

**Polarity:** color band denotes cathode end

ABSOLUTE MAXIMUM RATINGS				
PARAMETER	SYMBOL	TEST CONDITIONS	VALUES	UNITS
Peak repetitive reverse voltage	$V_{RRM}$		600	V
Average rectified forward current	$I_{F(AV)}$	$T_L = 117\text{ °C}^{(1)}$	4	A
Non-repetitive peak surge current	$I_{FSM}$	$T_J = 25\text{ °C}$ , 6 ms square pulse	120	
Operating junction and storage temperatures	$T_J, T_{Stg}$		-55 to +175	°C

#### Note

<sup>(1)</sup> Mounted on PCB with minimum pad size

ELECTRICAL SPECIFICATIONS ( $T_J = 25\text{ °C}$ unless otherwise specified)						
PARAMETER	SYMBOL	TEST CONDITIONS	MIN.	TYP.	MAX.	UNITS
Breakdown voltage, blocking voltage	$V_{BR}, V_R$	$I_R = 100\text{ }\mu\text{A}$	600	-	-	V
Forward voltage	$V_F$	$I_F = 4\text{ A}$	-	1.07	1.3	
		$I_F = 4\text{ A}$ , $T_J = 150\text{ °C}$	-	0.88	1.1	
Reverse leakage current	$I_R$	$V_R = V_R$ rated	-	-	3	$\mu\text{A}$
		$T_J = 150\text{ °C}$ , $V_R = V_R$ rated	-	-	100	
Junction capacitance	$C_T$	$V_R = 600\text{ V}$	-	7.8	-	pF



DYNAMIC RECOVERY CHARACTERISTICS (T <sub>J</sub> = 25 °C unless otherwise specified)						
PARAMETER	SYMBOL	TEST CONDITIONS	MIN.	TYP.	MAX.	UNITS
Reverse recovery time	t <sub>rr</sub>	I <sub>F</sub> = 1.0 A, di <sub>F</sub> /dt = 100 A/μs, V <sub>R</sub> = 30 V	-	45	-	ns
		I <sub>F</sub> = 1.0 A, di <sub>F</sub> /dt = 50 A/μs, V <sub>R</sub> = 30 V	-	50	-	
		I <sub>F</sub> = 0.5 A, I <sub>R</sub> = 1 A, I <sub>rr</sub> = 0.25 A	-	-	65	
		T <sub>J</sub> = 25 °C	-	41	-	
		T <sub>J</sub> = 125 °C	-	72	-	
Peak recovery current	I <sub>RRM</sub>	T <sub>J</sub> = 25 °C	-	5.8	-	A
		T <sub>J</sub> = 125 °C	-	8.0	-	
Reverse recovery charge	Q <sub>rr</sub>	T <sub>J</sub> = 25 °C	-	121	-	nC
		T <sub>J</sub> = 125 °C	-	300	-	

THERMAL - MECHANICAL SPECIFICATIONS						
PARAMETER	SYMBOL	TEST CONDITIONS	MIN.	TYP.	MAX.	UNITS
Maximum junction and storage temperature range	T <sub>J</sub> , T <sub>Stg</sub>		-55	-	+175	°C
Thermal resistance, junction to mount	R <sub>thJM</sub> <sup>(1)</sup>		-	-	14	°C/W
Thermal resistance, junction to ambient	R <sub>thJA</sub> <sup>(1)</sup>		-	-	80	
Approximate Weight				0.24		g
				0.008		oz.
Marking device		Case style SMC (DO-214AB)		4U6		

**Note**

<sup>(1)</sup> Mounted on PCB with minimum pad size

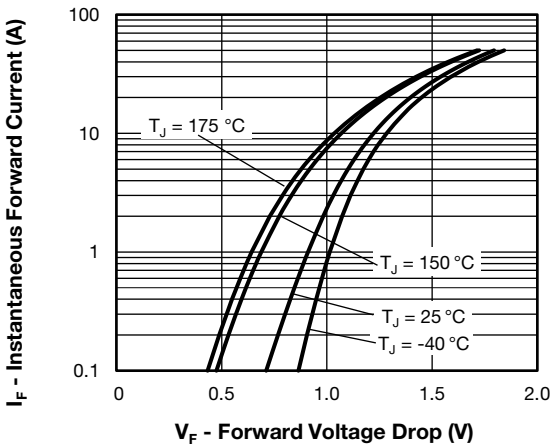

Fig. 1 - Typical Forward Voltage Drop Characteristics

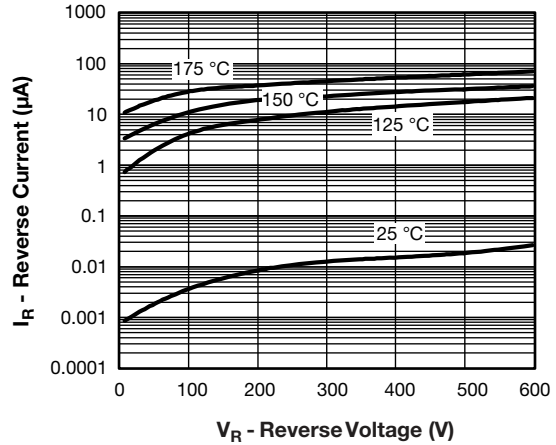

Fig. 2 - Typical Values of Reverse Current vs. Reverse Voltage

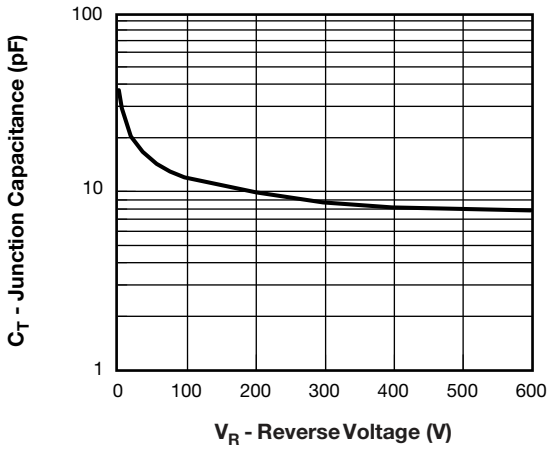

Fig. 3 - Typical Junction Capacitance vs. Reverse Voltage

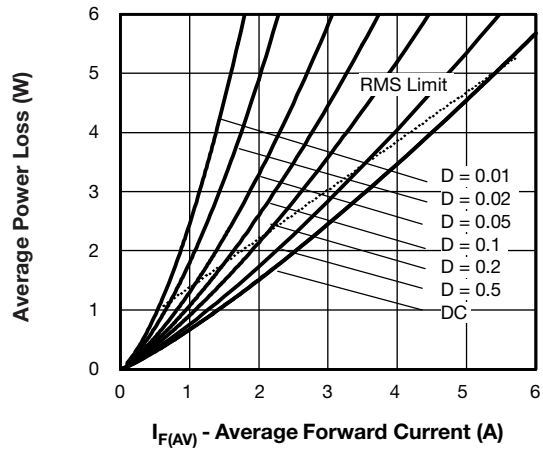

Fig. 5 - Forward Power Loss Characteristics

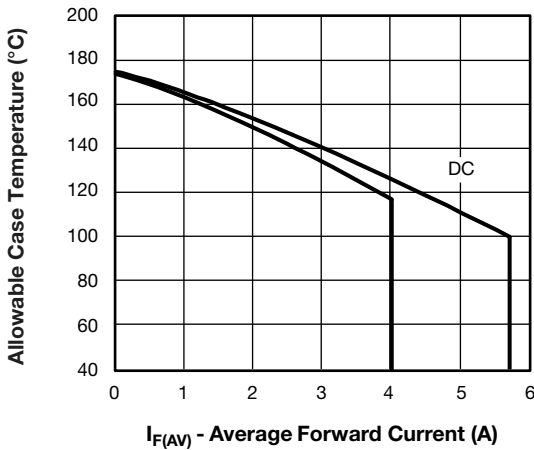

Fig. 4 - Maximum Allowable Case Temperature vs. Average Forward Current

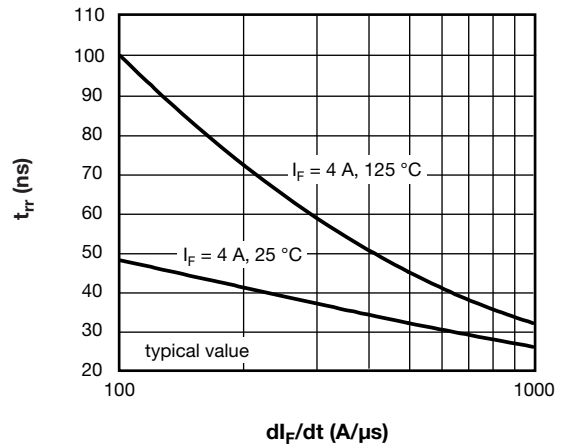

Fig. 6 - Typical Reverse Recovery vs.  $di_F/dt$

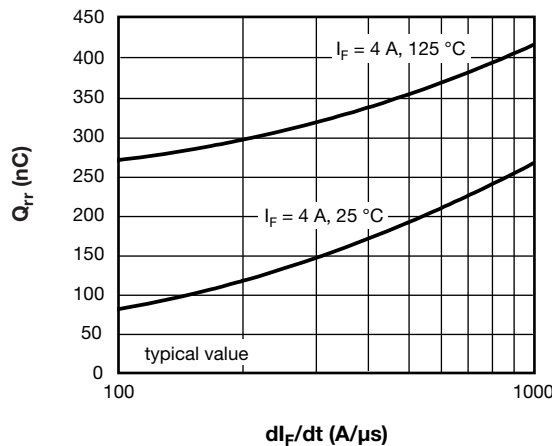
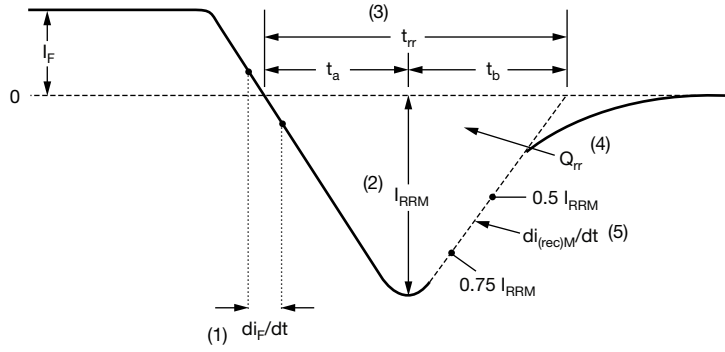

Fig. 7 - Typical Stored Charge vs.  $di_F/dt$



- (1)  $di_F/dt$  - rate of change of current through zero crossing
- (2)  $I_{RRM}$  - peak reverse recovery current
- (3)  $t_{rr}$  - reverse recovery time measured from zero crossing point of negative going  $I_F$  to point where a line passing through  $0.75 I_{RRM}$  and  $0.50 I_{RRM}$  extrapolated to zero current.
- (4)  $Q_{rr}$  - area under curve defined by  $t_{rr}$  and  $I_{RRM}$
- (5)  $di_{(rec)M}/dt$  - peak rate of change of current during  $t_b$  portion of  $t_{rr}$

$$Q_{rr} = \frac{t_{rr} \times I_{RRM}}{2}$$

Fig. 8 - Reverse Recovery Waveform and Definitions

**ORDERING INFORMATION TABLE**

Device code	<b>VS-</b>	<b>4</b>	<b>E</b>	<b>C</b>	<b>U</b>	<b>06</b>	<b>-M3</b>
	①	②	③	④	⑤	⑥	⑦

- 1** - Vishay Semiconductors product
- 2** - Current rating (4 = 4 A)
- 3** - Circuit configuration:  
E = single diode
- 4** - C = SMC package
- 5** - Process type,  
U = ultrafast recovery
- 6** - Voltage code (06 = 600 V)
- 7** - M3 = halogen-free, RoHS-compliant, and terminations lead (Pb)-free

<b>ORDERING INFORMATION</b> (Example)			
PREFERRED P/N	QUANTITY PER TUBE	MINIMUM ORDER QUANTITY	PACKAGING DESCRIPTION
VS-4ECU06-M3/9AT	9AT	3500	13" diameter plastic tape and reel

<b>LINKS TO RELATED DOCUMENTS</b>	
Dimensions	<a href="http://www.vishay.com/doc?95402">www.vishay.com/doc?95402</a>
Part marking information	<a href="http://www.vishay.com/doc?95472">www.vishay.com/doc?95472</a>
Packaging information	<a href="http://www.vishay.com/doc?95404">www.vishay.com/doc?95404</a>

## SMC

**DIMENSIONS** in inches (millimeters)

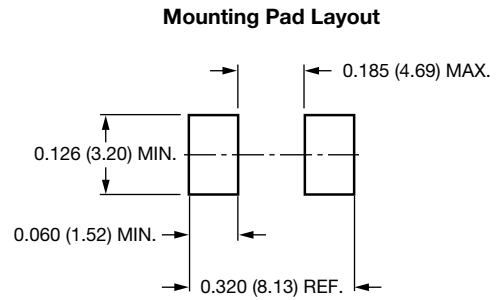
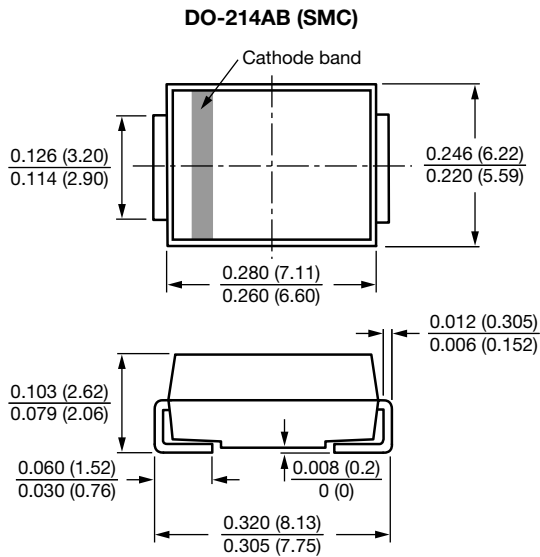



## **Disclaimer**

ALL PRODUCT, PRODUCT SPECIFICATIONS AND DATA ARE SUBJECT TO CHANGE WITHOUT NOTICE TO IMPROVE RELIABILITY, FUNCTION OR DESIGN OR OTHERWISE.

Vishay Intertechnology, Inc., its affiliates, agents, and employees, and all persons acting on its or their behalf (collectively, "Vishay"), disclaim any and all liability for any errors, inaccuracies or incompleteness contained in any datasheet or in any other disclosure relating to any product.

Vishay makes no warranty, representation or guarantee regarding the suitability of the products for any particular purpose or the continuing production of any product. To the maximum extent permitted by applicable law, Vishay disclaims (i) any and all liability arising out of the application or use of any product, (ii) any and all liability, including without limitation special, consequential or incidental damages, and (iii) any and all implied warranties, including warranties of fitness for particular purpose, non-infringement and merchantability.

Statements regarding the suitability of products for certain types of applications are based on Vishay's knowledge of typical requirements that are often placed on Vishay products in generic applications. Such statements are not binding statements about the suitability of products for a particular application. It is the customer's responsibility to validate that a particular product with the properties described in the product specification is suitable for use in a particular application. Parameters provided in datasheets and / or specifications may vary in different applications and performance may vary over time. All operating parameters, including typical parameters, must be validated for each customer application by the customer's technical experts. Product specifications do not expand or otherwise modify Vishay's terms and conditions of purchase, including but not limited to the warranty expressed therein.

Hyperlinks included in this datasheet may direct users to third-party websites. These links are provided as a convenience and for informational purposes only. Inclusion of these hyperlinks does not constitute an endorsement or an approval by Vishay of any of the products, services or opinions of the corporation, organization or individual associated with the third-party website. Vishay disclaims any and all liability and bears no responsibility for the accuracy, legality or content of the third-party website or for that of subsequent links.

Except as expressly indicated in writing, Vishay products are not designed for use in medical, life-saving, or life-sustaining applications or for any other application in which the failure of the Vishay product could result in personal injury or death. Customers using or selling Vishay products not expressly indicated for use in such applications do so at their own risk. Please contact authorized Vishay personnel to obtain written terms and conditions regarding products designed for such applications.

No license, express or implied, by estoppel or otherwise, to any intellectual property rights is granted by this document or by any conduct of Vishay. Product names and markings noted herein may be trademarks of their respective owners.