

Fast Recovery Diodes (Stud Version), 40 A/70 A/85 A



DO-203AB (DO-5)

FEATURES

- Short reverse recovery time
- Low stored charge
- Wide current range
- Excellent surge capabilities
- Stud cathode and stud anode versions
- Types up to 100 V_{RRM}
- Compliant to RoHS directive 2002/95/EC



TYPICAL APPLICATIONS

- DC power supplies
- Inverters
- Converters
- Choppers
- Ultrasonic systems
- Freewheeling diodes

PRODUCT SUMMARY

I _{F(AV)}	40 A/70 A/85 A
--------------------	----------------

MAJOR RATINGS AND CHARACTERISTICS

SYMBOL	CHARACTERISTICS	40HFL	70HFL	85HFL	UNITS
I _{F(AV)}		40	70	85	A
	Maximum T _C	85	85	85	°C
I _{FSM}	50 Hz	400	700	1100	A
	60 Hz	420	730	1151	
I ² t	50 Hz	800	2450	6050	A ² s
	60 Hz	730	2240	5523	
I ² √t		11 300	34 650	85 560	I ² √s
V _{RRM}	Range	100 to 1000			V
t _{rr}		See Recovery Characteristics table			ns
T _J	Range	- 40 to 125			°C

40HFL, 70HFL, 85HFL Series



Vishay High Power Products

Fast Recovery Diodes
(Stud Version), 40 A/70 A/85 A

ELECTRICAL SPECIFICATIONS

VOLTAGE RATINGS				
TYPE NUMBER ⁽¹⁾	V _{RRM} , MAXIMUM PEAK REPETITIVE REVERSE VOLTAGE T _J = - 40 °C TO 125 °C V	V _{RSM} , MAXIMUM PEAK NON-REPETITIVE REVERSE VOLTAGE T _J = 25 °C TO 125 °C V	I _{FM} , MAXIMUM PEAK REVERSE CURRENT AT RATED V _{RRM} mA	
			T _J = 25 °C	T _J = 125 °C
40HFL10S02, 40HFL10S05, 40HFL10S10	100	150	0.1	10
40HFL20S02, 40HFL20S05, 40HFL20S10	200	300		
40HFL40S02, 40HFL40S05, 40HFL40S10	400	500		
40HFL60S02, 40HFL60S05, 40HFL60S10	600	700		
40HFL80S05, 40HFL80S10	800	900		
40HFL100S05, 40HFL100S10	1000	1100		
70HFL10S02, 70HFL10S05, 70HFL10S10	100	150	0.1	15
70HFL20S02, 70HFL20S05, 70HFL20S10	200	300		
70HFL40S02, 70HFL40S05, 70HFL40S10	400	500		
70HFL60S02, 70HFL60S05, 70HFL60S10	600	700		
70HFL80S05, 70HFL80S10	800	900		
70HFL100S05, 70HFL100S10	1000	1100		
85HFL10S02, 85HFL10S05, 85HFL10S10	100	150	0.1	20
85HFL20S02, 85HFL20S05, 85HFL20S10	200	300		
85HFL40S02, 85HFL40S05, 85HFL40S10	400	500		
85HFL60S02, 85HFL60S05, 85HFL60S10	600	700		
85HFL80S05, 85HFL80S10	800	900		
85HFL100S05, 85HFL100S10	1000	1100		

Note

⁽¹⁾ Types listed are cathode case, for anode case add "R" to code, i.e. 40HFLR20S02, 85HFLR100S05 etc.



40HFL, 70HFL, 85HFL Series

Fast Recovery Diodes (Stud Version), 40 A/70 A/85 A Vishay High Power Products

FORWARD CONDUCTION							
PARAMETER	SYMBOL	TEST CONDITIONS		40HFL	70HFL	85HFL	UNITS
Maximum average forward current at maximum case temperature	$I_{F(AV)}$	180° conduction, half sine wave		40	70	85	A
				75			°C
Maximum RMS forward current	$I_{F(RMS)}$			63	110	134	A
Maximum peak repetitive forward current	I_{FRM}	Sinusoidal half wave, 30° conduction		220	380	470	A
Maximum peak, one-cycle non-repetitive forward current	I_{FSM}	t = 10 ms	Sinusoidal half wave, 100 % V_{RRM} reapplied, initial $T_J = T_J$ maximum	400	700	1100	A
		t = 8.3 ms		420	730	1151	
		t = 10 ms	Sinusoidal half wave, no voltage reapplied, initial $T_J = T_J$ maximum	475	830	1308	
		t = 8.3 ms		500	870	1369	
Maximum I^2t for fusing	I^2t	t = 10 ms	100 % V_{RRM} reapplied, initial $T_J = T_J$ maximum	800	2450	6050	A^2s
		t = 8.3 ms		730	2240	5523	
		t = 10 ms	No voltage reapplied, initial $T_J = T_J$ maximum	1130	3460	8556	
		t = 8.3 ms		1030	3160	7810	
Maximum $I^2\sqrt{t}$ for fusing (1)	$I^2\sqrt{t}$	t = 0.1 ms to 10 ms, no voltage reapplied		11 300	34 650	85 560	$A^2\sqrt{s}$
Maximum value of threshold voltage	$V_{F(TO)}$	$T_J = 125\text{ °C}$		1.081	1.085	1.128	V
Maximum value of forward slope resistance	r_F			6.33	3.40	2.11	mΩ
Maximum forward voltage drop	V_{FM}	$T_J = 25\text{ °C}, I_{FM} = \pi \times I_{F(AV)}$		1.95	1.85	1.75	V

Note

(1) I^2t for time $t_x = I^2\sqrt{t} \cdot \sqrt{t_x}$

RECOVERY CHARACTERISTICS												
PARAMETER	SYMBOL	TEST CONDITIONS	40HFL...			70HFL...			85HFL...			UNITS
			S02	S05	S10	S02	S05	S10	S02	S05	S10	
Typical reverse recovery time	t_{rr}	$T_J = 25\text{ °C}, I_F = 1\text{ A to } V_R = 30\text{ V}, -di_F/dt = 100\text{ A}/\mu\text{s}$	70	180	350	60	150	290	50	120	270	ns
		$T_J = 25\text{ °C}, -di_F/dt = 25\text{ A}/\mu\text{s}, I_{FM} = \pi \times \text{rated } I_{F(AV)}$	200	500	1000	200	500	1000	200	500	1000	
Typical reverse recovered charge	Q_{rr}	$T_J = 25\text{ °C}, I_F = 1\text{ A to } V_R = 30\text{ V}, -di_F/dt = 100\text{ A}/\mu\text{s}$	160	750	3100	90	500	1600	70	340	1350	nC
		$T_J = 25\text{ °C}, -di_F/dt = 25\text{ A}/\mu\text{s}, I_{FM} = \pi \times \text{rated } I_{F(AV)}$	240	1300	6000	240	1300	6000	240	1300	6000	

40HFL, 70HFL, 85HFL Series



Vishay High Power Products

Fast Recovery Diodes
(Stud Version), 40 A/70 A/85 A

THERMAL AND MECHANICAL SPECIFICATIONS						
PARAMETER	SYMBOL	TEST CONDITIONS	40HFL	70HFL	85HFL	UNITS
Junction operating temperature range	T_J		- 40 to 125			°C
Storage temperature range	T_{Stg}		- 40 to 150			
Maximum thermal resistance, junction to case	R_{thJC}	DC operation	0.60	0.36	0.30	K/W
Maximum thermal resistance, case to heatsink	R_{thCS}	Mounting surface, smooth, flat and greased	0.25			
Maximum allowable mounting torque (+ 0 %, - 10 %)		Not lubricated thread, tightening on nut ⁽¹⁾	3.4 (30)			N · m (lbf · in)
		Lubricated thread, tightening on nut ⁽¹⁾	2.3 (20)			
		Not lubricated thread, tightening on hexagon ⁽²⁾	4.2 (37)			
		Lubricated thread, tightening on hexagon ⁽²⁾	3.2 (28)			
Approximate weight			25			
			0.88			
Case style		JEDEC	DO-203AB (DO-5)			

Notes

- (1) Recommended for pass-through holes
- (2) Recommended for holed threaded heatsinks

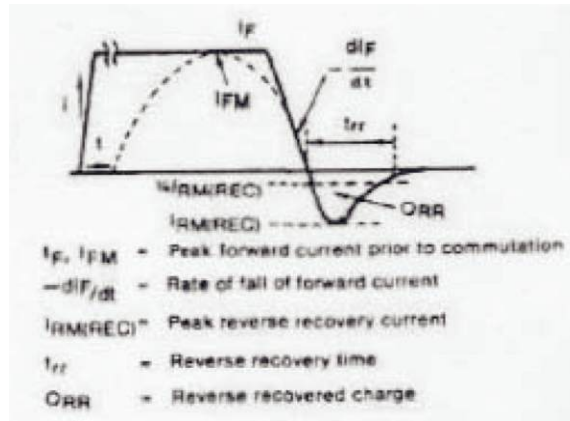

Fig. 1 - Reverse Recovery Time Test Waveform

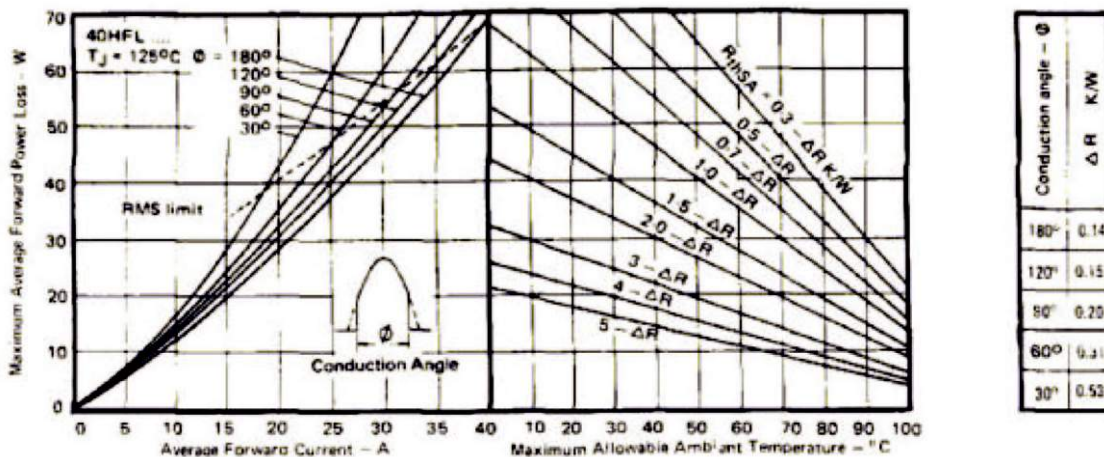

Fig. 2 - Current Rating Nomogram (Sinusoidal Waveforms), 40HFL Series



40HFL, 70HFL, 85HFL Series

Fast Recovery Diodes Vishay High Power Products
(Stud Version), 40 A/70 A/85 A

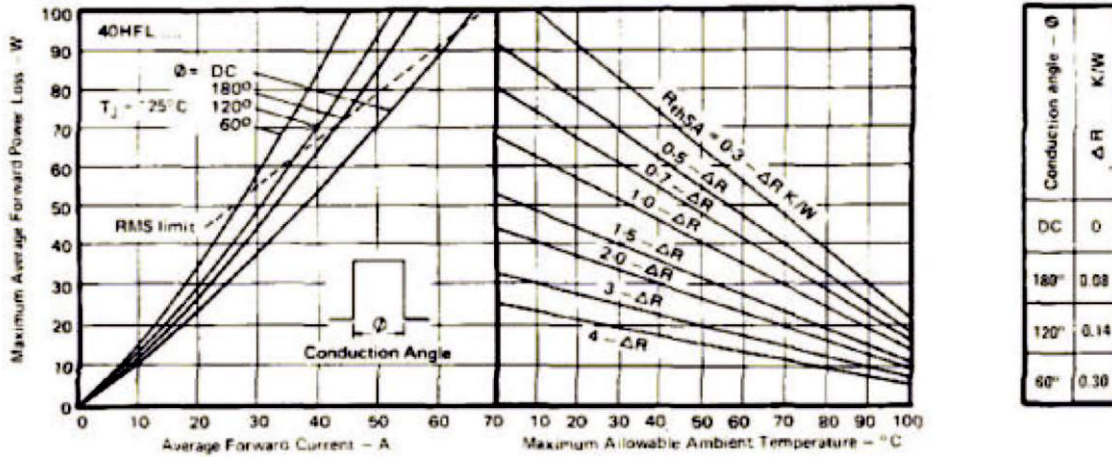

Fig. 3 - Current Rating Nomogram (Rectangular Waveforms), 40HFL Series

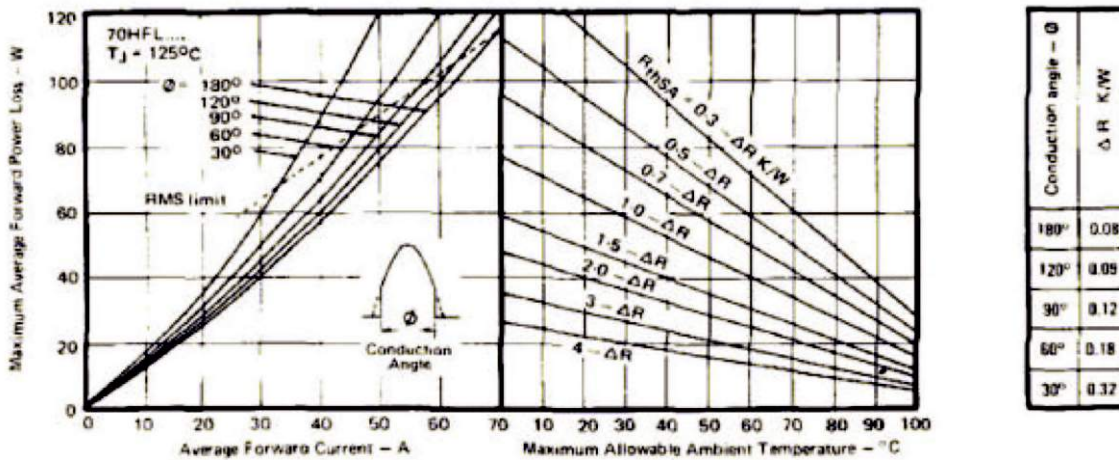

Fig. 4 - Current Rating Nomogram (Sinusoidal Waveforms), 70HFL Series

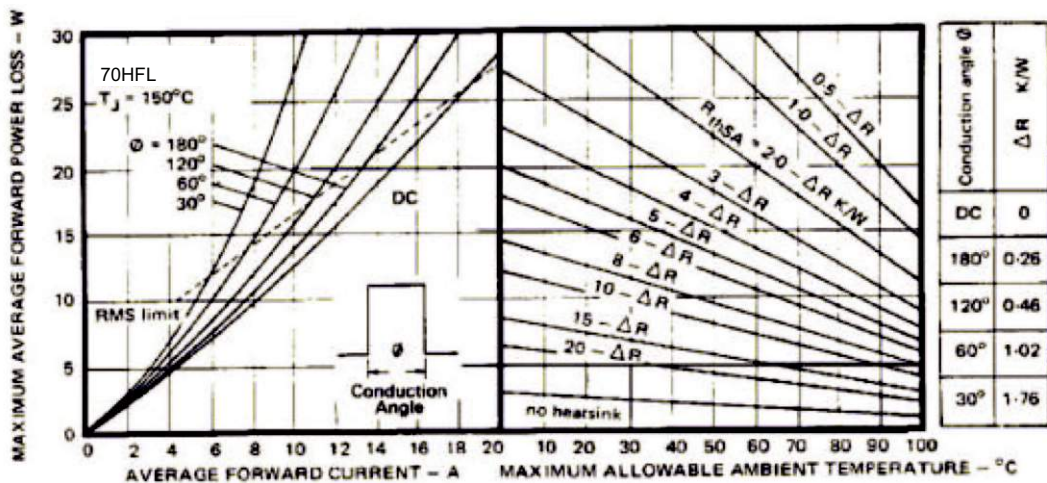

Fig. 5 - Current Rating Nomogram (Rectangular Waveforms), 70HFL Series

40HFL, 70HFL, 85HFL Series

Vishay High Power Products

Fast Recovery Diodes
(Stud Version), 40 A/70 A/85 A

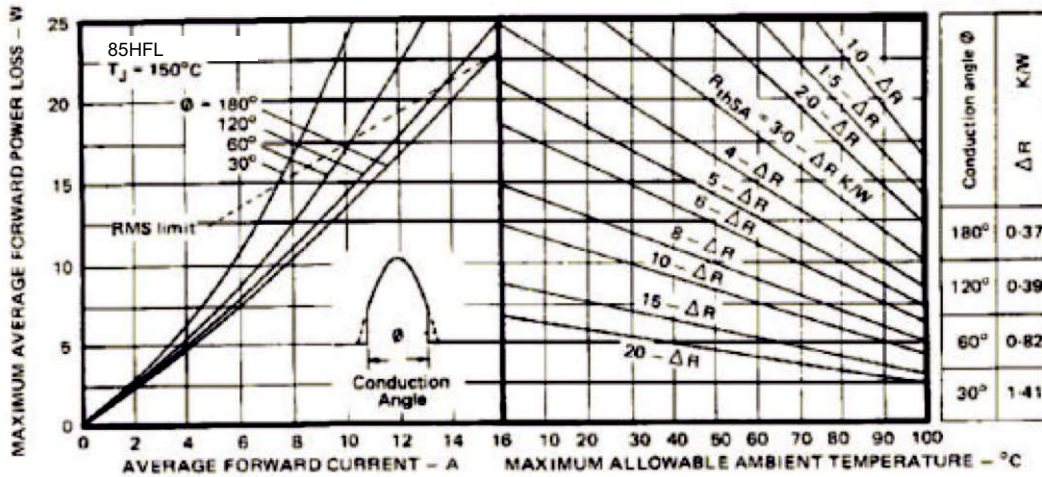

Fig. 6 - Current Rating Nomogram (Sinusoidal Waveforms), 85HFL Series

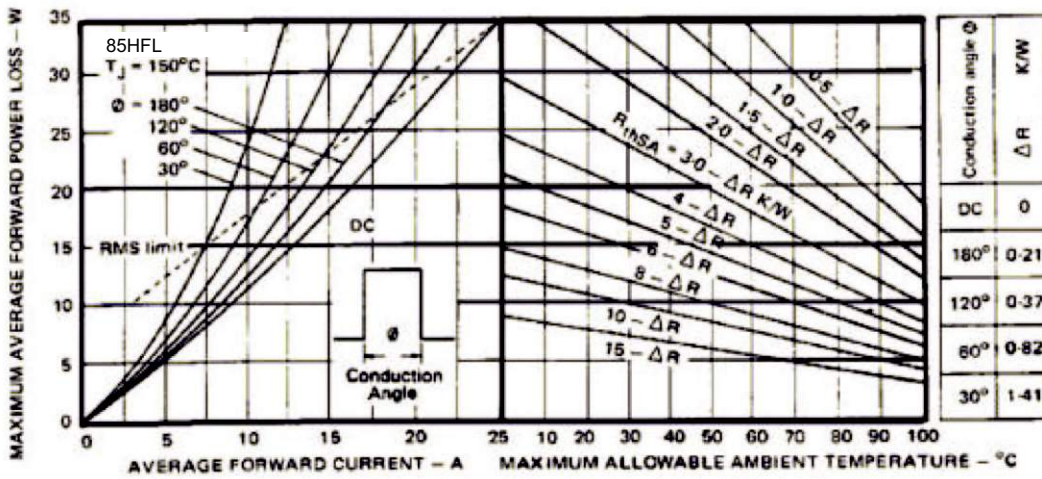

Fig. 7 - Current Rating Nomogram (Rectangular Waveforms), 85HFL Series

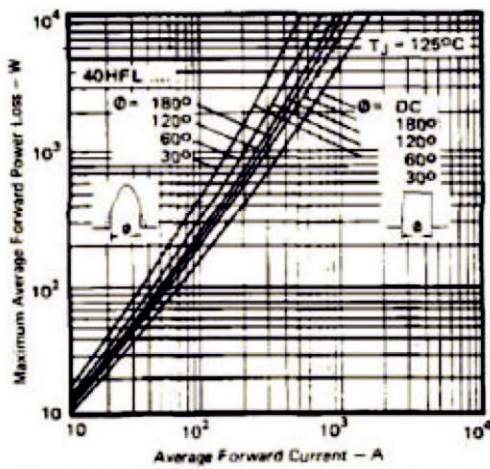

Fig. 8 - Maximum High Level Forward Power Loss vs. Average Forward Current, 40HFL Series

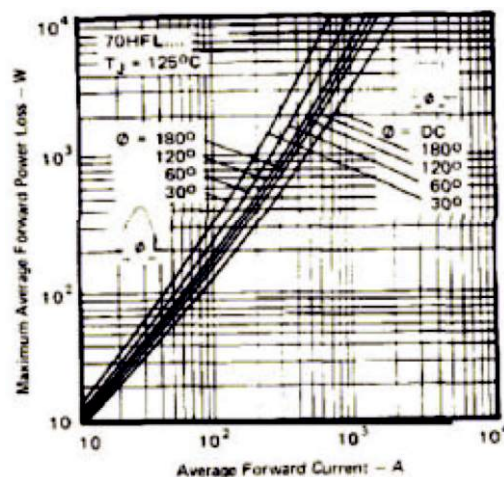

Fig. 9 - Maximum High Level Forward Power Loss vs. Average Forward Current, 70HFL Series

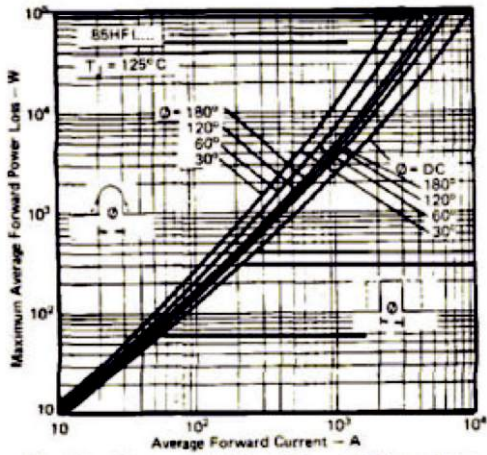

Fig. 10 - Maximum High Level Forward Power Loss vs. Average Forward Current, 85HFL Series

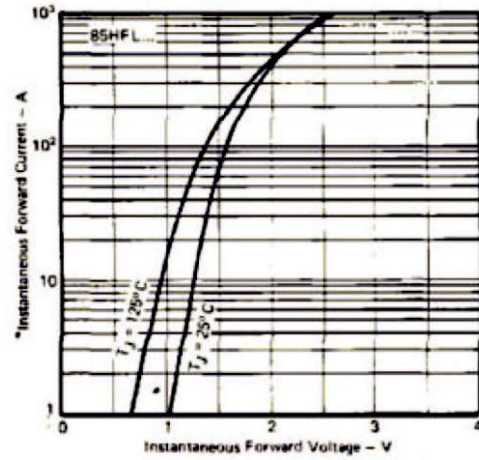

Fig. 13 - Maximum Forward Voltage vs. Forward Current, 85HFL Series

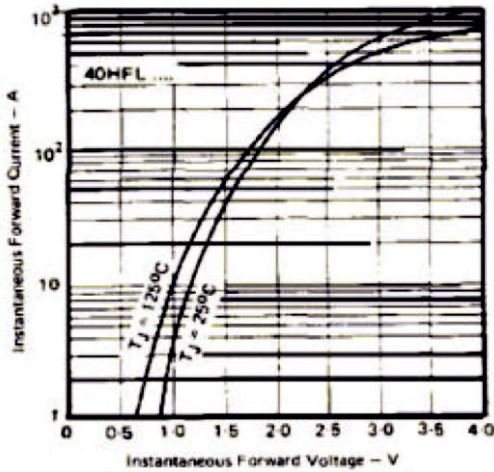

Fig. 11 - Maximum Forward Voltage vs. Forward Current, 40HFL Series

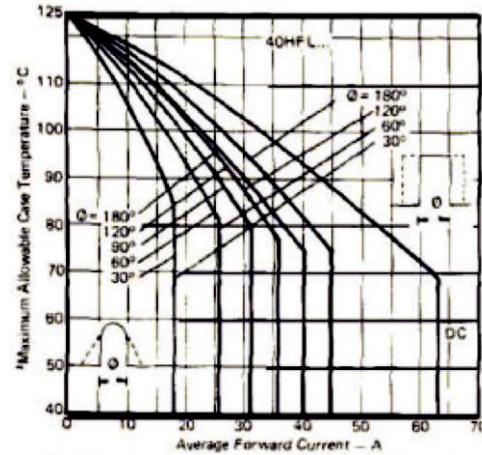

Fig. 14 - Average Forward Current vs. Maximum Allowable Case Temperature, 40HFL Series

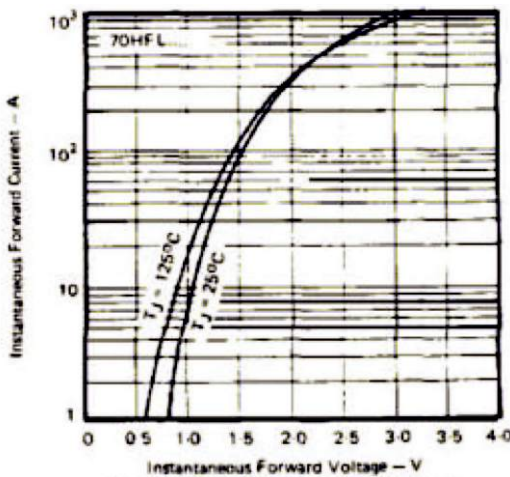

Fig. 12 - Maximum Forward Voltage vs. Forward Current, 70HFL Series

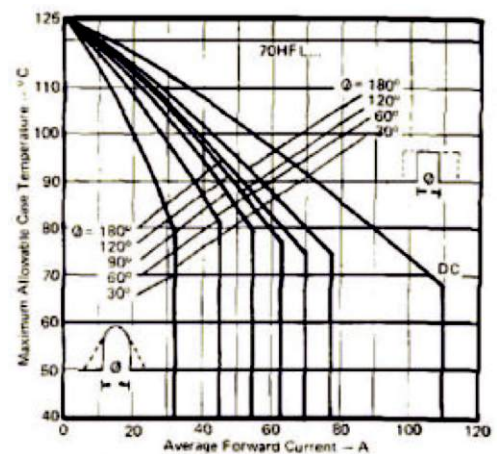

Fig. 15 - Average Forward Current vs. Maximum Allowable Case Temperature, 70HFL Series

40HFL, 70HFL, 85HFL Series



Vishay High Power Products

Fast Recovery Diodes
(Stud Version), 40 A/70 A/85 A

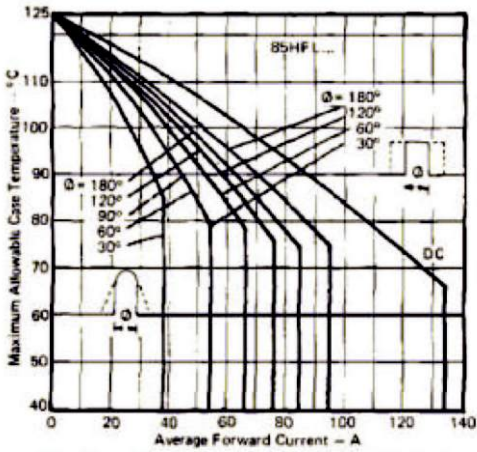

Fig. 16 - Average Forward Current vs. Maximum Allowable Case Temperature, 85HFL Series

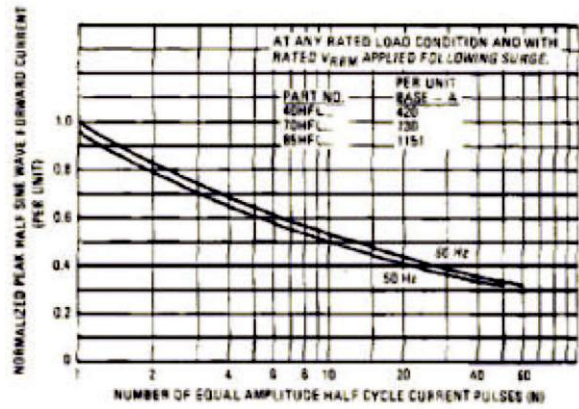

Fig. 17 - Maximum Non-Repetitive Surge Current vs. Number of Current Pulses, All Series

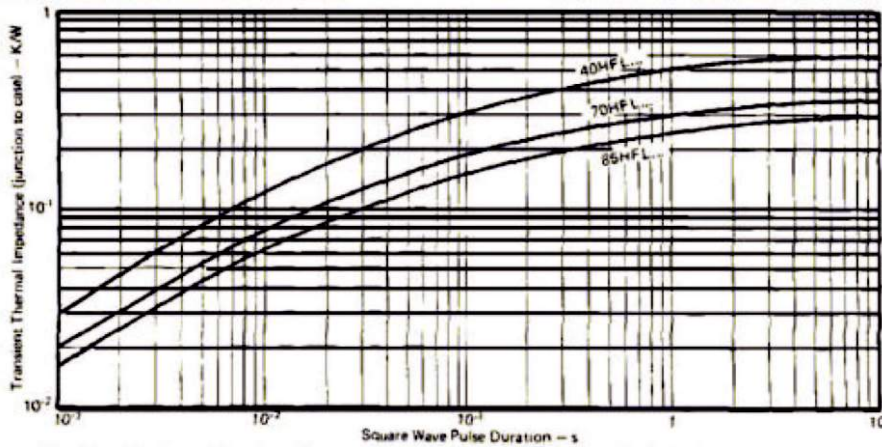

Fig. 18 - Maximum Transient Thermal Impedance, Junction to Case vs. Pulse Duration, All Series

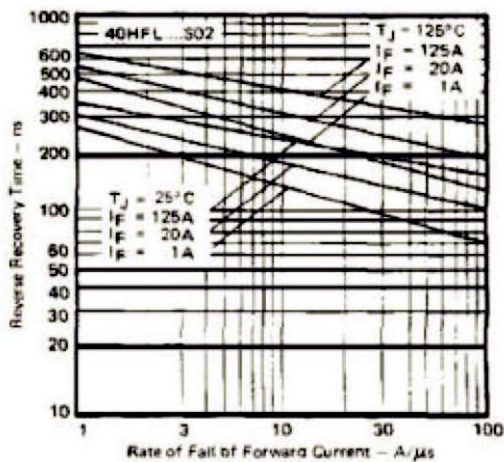

Fig. 19 - Typical Reverse Recovery Time vs. Rate of Fall of Forward Current, 40HFL...S02 Series

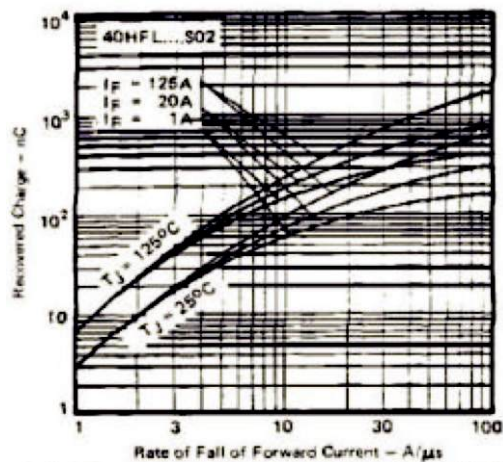

Fig. 20 - Typical Recovered Charge vs. Rate of Fall of Forward Current, 40HFL...S02 Series

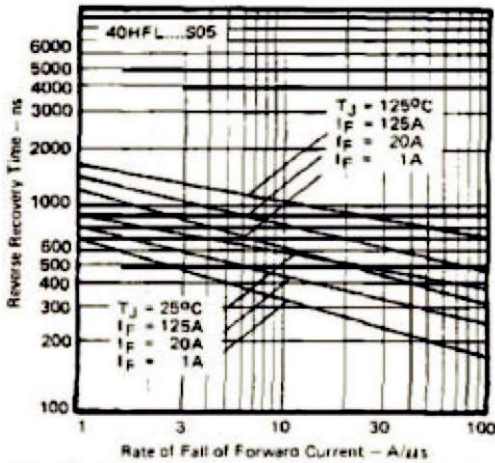

Fig. 21 - Typical Reverse Recovery Time vs. Rate of Fall of Forward Current, 40HFL...S05 Series

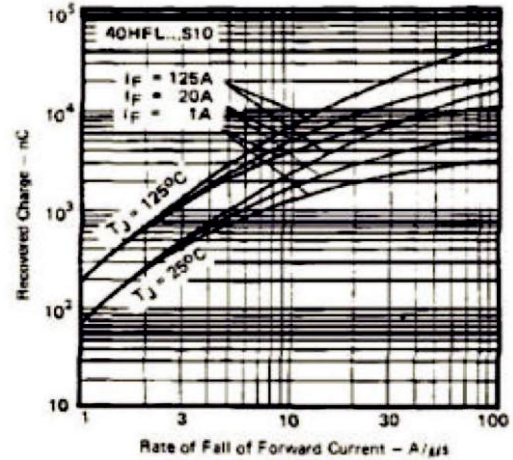

Fig. 24 - Typical Recovered Charge vs. Rate of Fall of Forward Current, 40HFL...S10 Series

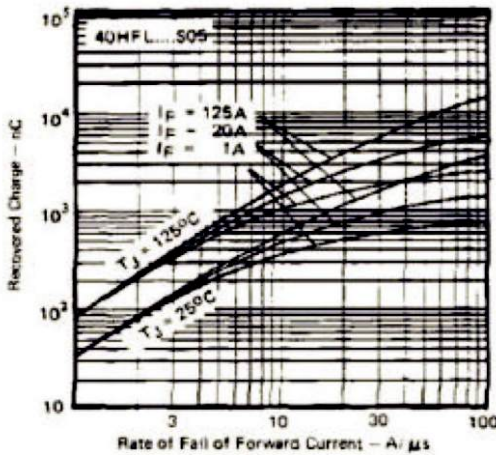

Fig. 22 - Typical Recovered Charge vs. Rate of Fall of Forward Current, 40HFL...S05 Series

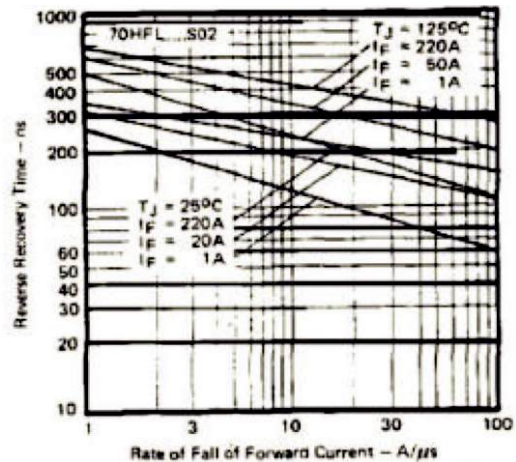

Fig. 25 - Typical Reverse Recovery Time vs. Rate of Fall of Forward Current, 70HFL...S02 Series

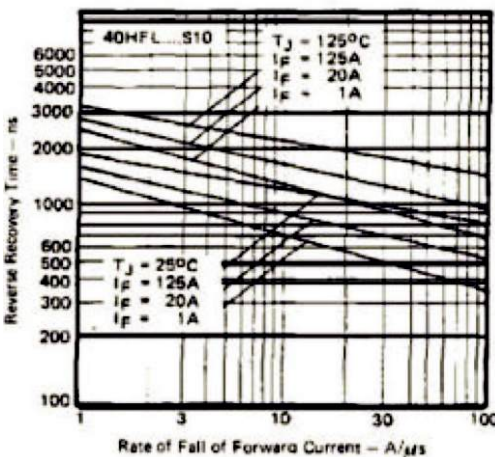

Fig. 23 - Typical Reverse Recovery Time vs. Rate of Fall of Forward Current, 40HFL...S10 Series

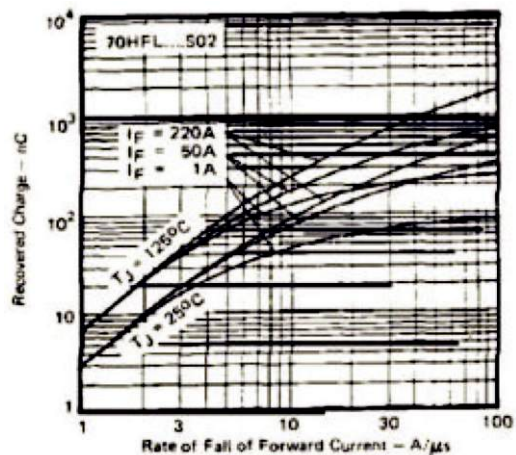

Fig. 26 - Typical Recovered Charge vs. Rate of Fall of Forward Current, 70HFL...S02 Series

40HFL, 70HFL, 85HFL Series



Vishay High Power Products

Fast Recovery Diodes
(Stud Version), 40 A/70 A/85 A

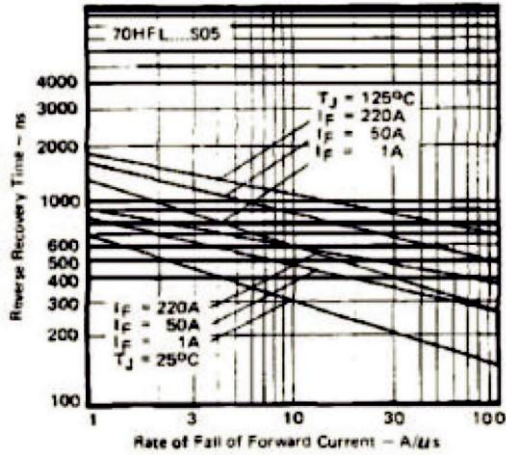

Fig. 27 - Typical Reverse Recovery Time vs. Rate of Fall of Forward Current, 70HFL...S05 Series

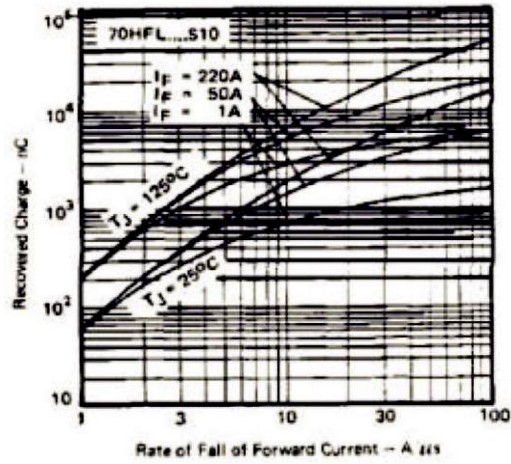

Fig. 30 - Typical Recovered Charge vs. Rate of Fall of Forward Current, 70HFL...S10 Series

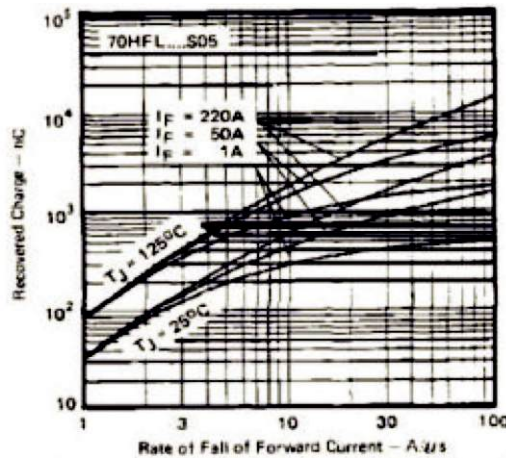

Fig. 28 - Typical Recovered Charge vs. Rate of Fall of Forward Current, 70HFL...S05 Series

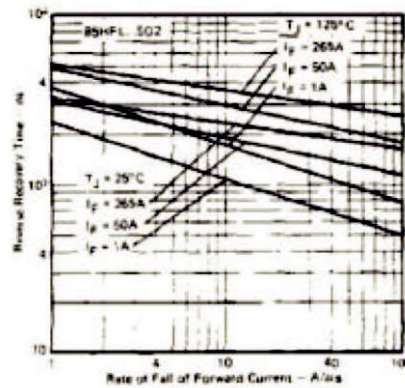

Fig. 31 - Typical Reverse Recovery Time vs. Rate of Fall of Forward Current, 85HFL...S02 Series

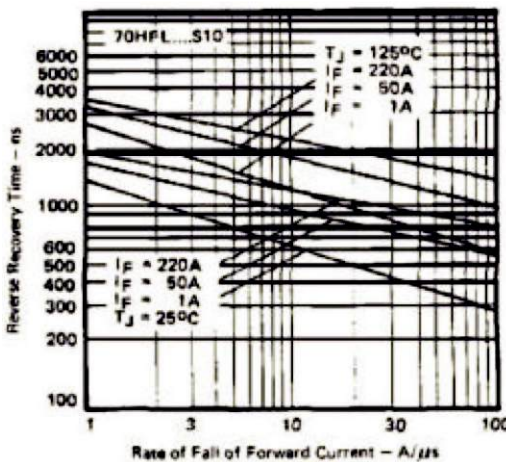

Fig. 29 - Typical Reverse Recovery Time vs. Rate of Fall of Forward Current, 70HFL...S10 Series

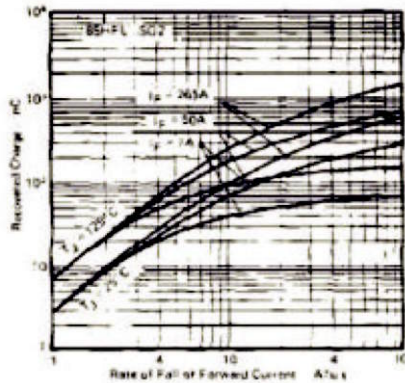

Fig. 32 - Typical Recovered Charge vs. Rate of Fall of Forward Current, 85HFL...S02 Series



40HFL, 70HFL, 85HFL Series

Fast Recovery Diodes
(Stud Version), 40 A/70 A/85 A

Vishay High Power Products

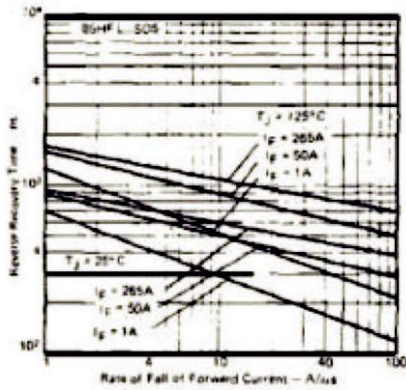

Fig. 33 - Typical Reverse Recovery Time vs. Rate of Fall of Forward Current, 85HFL...S05 Series

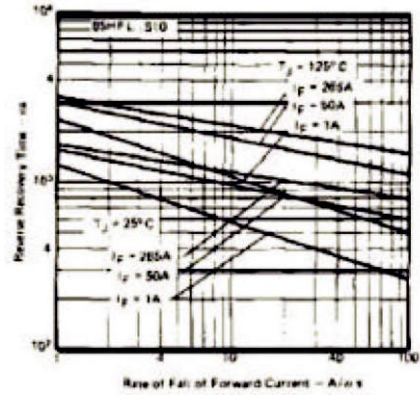

Fig. 35 - Typical Reverse Recovery Time vs. Rate of Fall of Forward Current, 85HFL...S10 Series

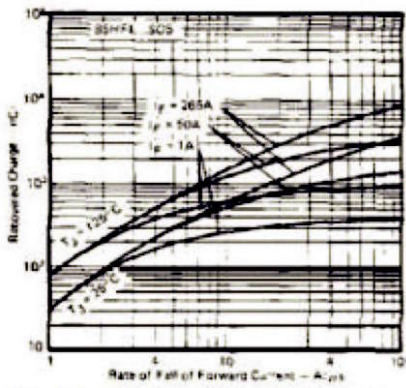

Fig. 34 - Typical Recovered Charge vs. Rate of Fall of Forward Current, 85HFL...S05 Series

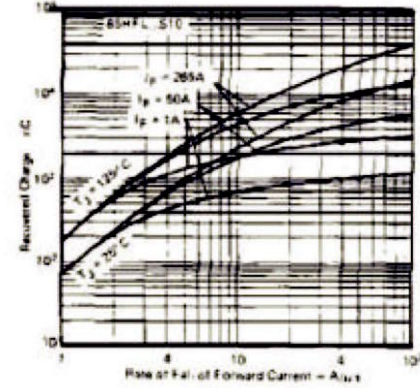

Fig. 36 - Typical Recovered Charge vs. Rate of Fall of Forward Current, 85HFL...S10 Series

LINKS TO RELATED DOCUMENTS

Dimensions

www.vishay.com/doc?95312

DO-203AB (DO-5) for 40HFL, 70HFL and 85HFL

DIMENSIONS FOR 40HFL/70HFL in millimeters (inches)

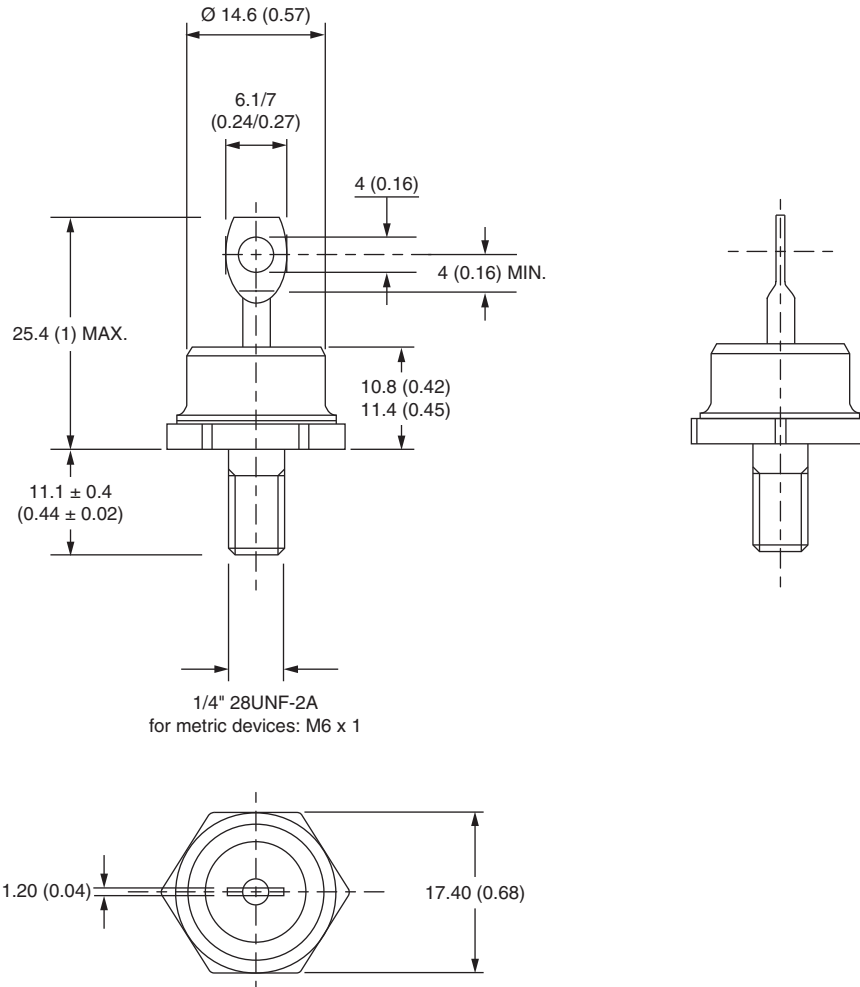

Outline Dimensions

Vishay Semiconductors

DO-203AB (DO-5) for
40HFL, 70HFL and 85HFL



DIMENSIONS FOR 85HFL in millimeters (inches)

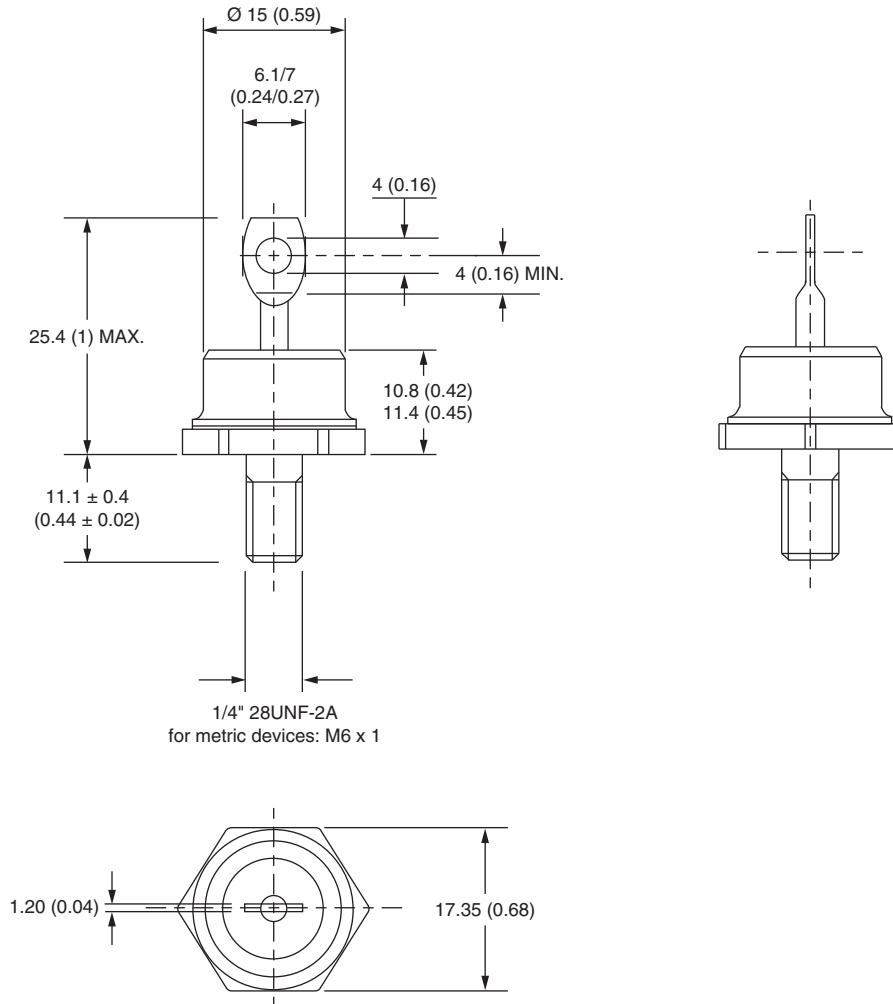



Disclaimer

ALL PRODUCT, PRODUCT SPECIFICATIONS AND DATA ARE SUBJECT TO CHANGE WITHOUT NOTICE TO IMPROVE RELIABILITY, FUNCTION OR DESIGN OR OTHERWISE.

Vishay Intertechnology, Inc., its affiliates, agents, and employees, and all persons acting on its or their behalf (collectively, "Vishay"), disclaim any and all liability for any errors, inaccuracies or incompleteness contained in any datasheet or in any other disclosure relating to any product.

Vishay makes no warranty, representation or guarantee regarding the suitability of the products for any particular purpose or the continuing production of any product. To the maximum extent permitted by applicable law, Vishay disclaims (i) any and all liability arising out of the application or use of any product, (ii) any and all liability, including without limitation special, consequential or incidental damages, and (iii) any and all implied warranties, including warranties of fitness for particular purpose, non-infringement and merchantability.

Statements regarding the suitability of products for certain types of applications are based on Vishay's knowledge of typical requirements that are often placed on Vishay products in generic applications. Such statements are not binding statements about the suitability of products for a particular application. It is the customer's responsibility to validate that a particular product with the properties described in the product specification is suitable for use in a particular application. Parameters provided in datasheets and/or specifications may vary in different applications and performance may vary over time. All operating parameters, including typical parameters, must be validated for each customer application by the customer's technical experts. Product specifications do not expand or otherwise modify Vishay's terms and conditions of purchase, including but not limited to the warranty expressed therein.

Except as expressly indicated in writing, Vishay products are not designed for use in medical, life-saving, or life-sustaining applications or for any other application in which the failure of the Vishay product could result in personal injury or death. Customers using or selling Vishay products not expressly indicated for use in such applications do so at their own risk. Please contact authorized Vishay personnel to obtain written terms and conditions regarding products designed for such applications.

No license, express or implied, by estoppel or otherwise, to any intellectual property rights is granted by this document or by any conduct of Vishay. Product names and markings noted herein may be trademarks of their respective owners.

Material Category Policy

Vishay Intertechnology, Inc. hereby certifies that all its products that are identified as RoHS-Compliant fulfill the definitions and restrictions defined under Directive 2011/65/EU of The European Parliament and of the Council of June 8, 2011 on the restriction of the use of certain hazardous substances in electrical and electronic equipment (EEE) - recast, unless otherwise specified as non-compliant.

Please note that some Vishay documentation may still make reference to RoHS Directive 2002/95/EC. We confirm that all the products identified as being compliant to Directive 2002/95/EC conform to Directive 2011/65/EU.

Vishay Intertechnology, Inc. hereby certifies that all its products that are identified as Halogen-Free follow Halogen-Free requirements as per JEDEC JS709A standards. Please note that some Vishay documentation may still make reference to the IEC 61249-2-21 definition. We confirm that all the products identified as being compliant to IEC 61249-2-21 conform to JEDEC JS709A standards.