

Insulated Ultrafast Rectifier Module, 170 A

SOT-227

**RoHS
COMPLIANT**

FEATURES

- Two fully independent diodes
- Fully insulated package
- Ultrafast, soft reverse recovery, with high operation junction temperature (T_J max. = 175 °C)
- Very low forward voltage drop
- Optimized for power conversion: welding and industrial SMPS applications
- Easy to use and parallel
- Industry standard outline
- UL approved file E78996 
- Designed and qualified for industrial level
- Material categorization: for definitions of compliance please see www.vishay.com/doc?99912

PRIMARY CHARACTERISTICS

| | |
|---|--------------------------|
| V_R | 600 V |
| $I_{F(AV)}$ per module at $T_C = 76$ °C | 170 A |
| t_{rr} | 60 ns |
| Type | Modules - diode FRED Pt® |
| Package | SOT-227 |

DESCRIPTION / APPLICATIONS

The VS-UFB170FA60 insulated modules integrate two state of the art ultrafast recovery rectifiers in the compact, industry standard SOT-227 package. The diodes structure, and its life time control, provide an ultrasoft recovery current shape, together with the best overall performance, ruggedness and reliability characteristics.

These devices are thus intended for high frequency applications in which the switching energy is designed not to be predominant portion of the total energy, such as in the output rectification stage of welding machines, SMPS, DC/DC converters. Their extremely optimized stored charge and low recovery current reduce both over dissipation in the switching elements (and snubbers) and EMI/RFI.

ABSOLUTE MAXIMUM RATINGS

| PARAMETER | SYMBOL | TEST CONDITIONS | MAX. | UNITS |
|---|----------------|-----------------------------------|-------------|-------|
| Cathode to anode voltage | V_R | | 600 | V |
| Continuous forward current per diode | I_F | $T_C = 90$ °C | 94 | A |
| Single pulse forward current per diode | I_{FSM} | $T_C = 25$ °C | 850 | |
| Maximum power dissipation per module | P_D | $T_C = 90$ °C | 233 | W |
| RMS isolation voltage | V_{ISOL} | Any terminal to case, $t = 1$ min | 2500 | V |
| Operating junction and storage temperatures | T_J, T_{Stg} | | -55 to +175 | °C |



| ELECTRICAL SPECIFICATIONS PER DIODE ($T_J = 25\text{ }^\circ\text{C}$ unless otherwise specified) | | | | | | |
|--|----------|--|------|------|------|---------------|
| PARAMETER | SYMBOL | TEST CONDITIONS | MIN. | TYP. | MAX. | UNITS |
| Cathode to anode breakdown voltage | V_{BR} | $I_R = 100\text{ }\mu\text{A}$ | 600 | - | - | V |
| Forward voltage, per leg | V_{FM} | $I_F = 50\text{ A}$ | - | 1.02 | 1.19 | |
| | | $I_F = 50\text{ A}, T_J = 175\text{ }^\circ\text{C}$ | - | 0.87 | - | |
| | | $I_F = 100\text{ A}$ | - | 1.17 | 1.43 | |
| Reverse leakage current, per leg | I_{RM} | $V_R = V_R$ rated | - | 0.5 | 50 | μA |
| | | $T_J = 175\text{ }^\circ\text{C}, V_R = V_R$ rated | - | 0.1 | 2 | mA |
| Junction capacitance, per leg | C_T | $V_R = 600\text{ V}$ | - | 43 | - | pF |

| DYNAMIC RECOVERY CHARACTERISTICS ($T_J = 25\text{ }^\circ\text{C}$ unless otherwise specified) | | | | | | |
|---|-----------|---|------|------|------|---------------|
| PARAMETER | SYMBOL | TEST CONDITIONS | MIN. | TYP. | MAX. | UNITS |
| Reverse recovery time, per leg | t_{rr} | $T_J = 25\text{ }^\circ\text{C}, I_F = 1\text{ A } dI_F/dt = 200\text{ A}/\mu\text{s } V_R = 30\text{ V}$ | - | 60 | - | ns |
| | | $T_J = 25\text{ }^\circ\text{C}$ | - | 170 | - | |
| | | $T_J = 125\text{ }^\circ\text{C}$ | - | 270 | - | |
| Peak recovery current, per leg | I_{RRM} | $T_J = 25\text{ }^\circ\text{C}$ | - | 40 | - | A |
| | | $T_J = 125\text{ }^\circ\text{C}$ | - | 54 | - | |
| Reverse recovery charge, per leg | Q_{rr} | $T_J = 25\text{ }^\circ\text{C}$ | - | 3.4 | - | μC |
| | | $T_J = 125\text{ }^\circ\text{C}$ | - | 6.8 | - | |
| Reverse recovery time, per leg | t_{rr} | $T_J = 25\text{ }^\circ\text{C}$ | - | 220 | - | ns |
| | | $T_J = 125\text{ }^\circ\text{C}$ | - | 300 | - | |
| Peak recovery current, per leg | I_{RRM} | $T_J = 25\text{ }^\circ\text{C}$ | - | 47 | - | A |
| | | $T_J = 125\text{ }^\circ\text{C}$ | - | 61 | - | |
| Reverse recovery charge, per leg | Q_{rr} | $T_J = 25\text{ }^\circ\text{C}$ | - | 5.2 | - | μC |
| | | $T_J = 125\text{ }^\circ\text{C}$ | - | 9.1 | - | |

| THERMAL - MECHANICAL SPECIFICATIONS | | | | | | |
|---|------------|-----------------------|------|------|------------|---------------------------|
| PARAMETER | SYMBOL | TEST CONDITIONS | MIN. | TYP. | MAX. | UNITS |
| Junction to case, single leg conducting | R_{thJC} | | - | - | 0.73 | $^\circ\text{C}/\text{W}$ |
| Junction to case, both leg conducting | | | - | - | 0.365 | |
| Case to heatsink | R_{thCS} | Flat, greased surface | - | 0.10 | - | |
| Weight | | | - | 30 | - | g |
| Mounting torque | | Torque to terminal | - | - | 1.1 (9.7) | Nm (lbf.in) |
| | | Torque to heatsink | - | - | 1.8 (15.9) | Nm (lbf.in) |
| Case style | | | | | | SOT-227 |

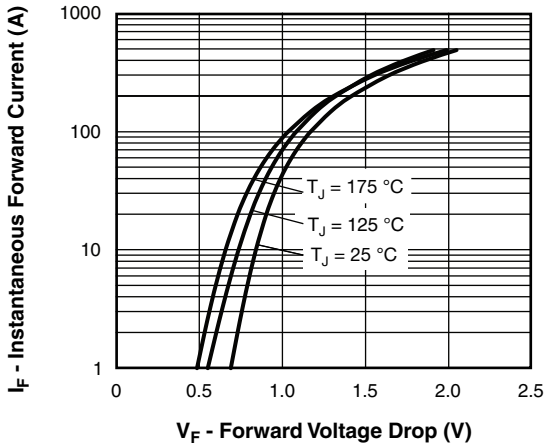

Fig. 1 - Typical Forward Voltage Drop Characteristics (Per Leg)

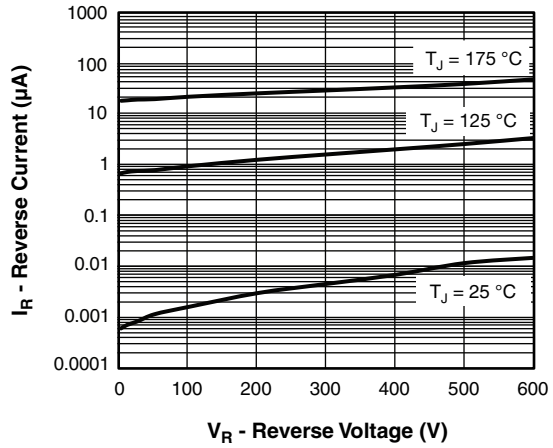

Fig. 2 - Typical Reverse Current vs. Reverse Voltage (Per Leg)

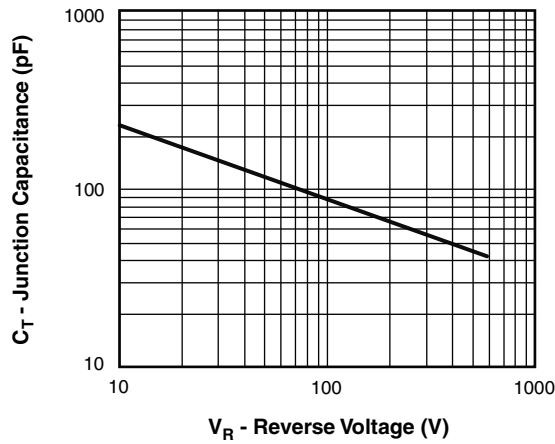

Fig. 3 - Typical Junction Capacitance vs. Reverse Voltage (Per Leg)

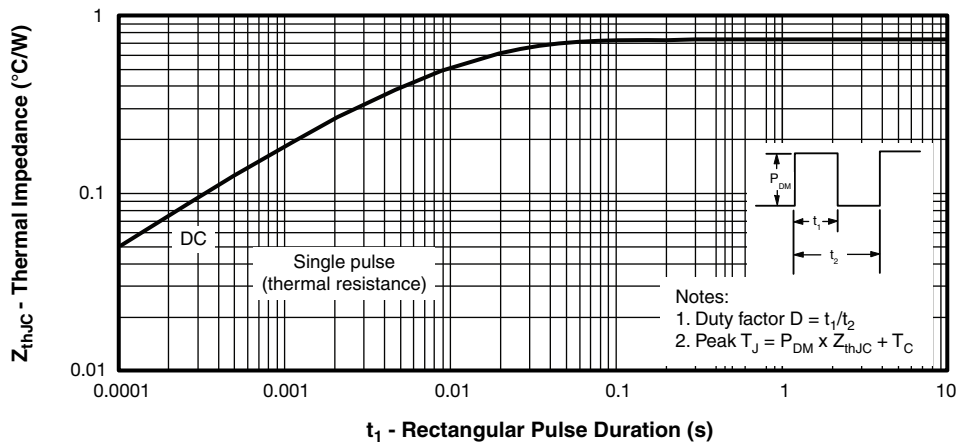

Fig. 4 - Maximum Thermal Impedance Z_{thJC} Characteristics (Per Leg)

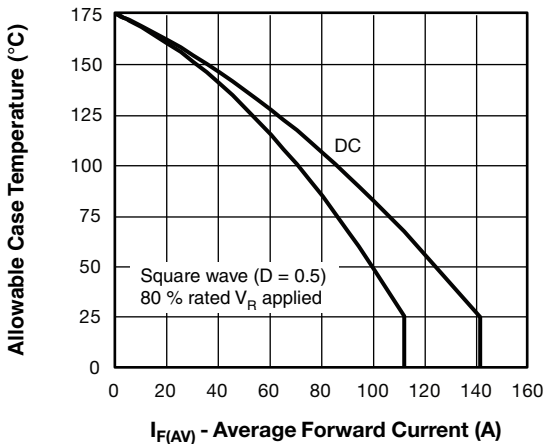

Fig. 5 - Allowable Case Temperature vs. Average Forward Current (Per Leg)

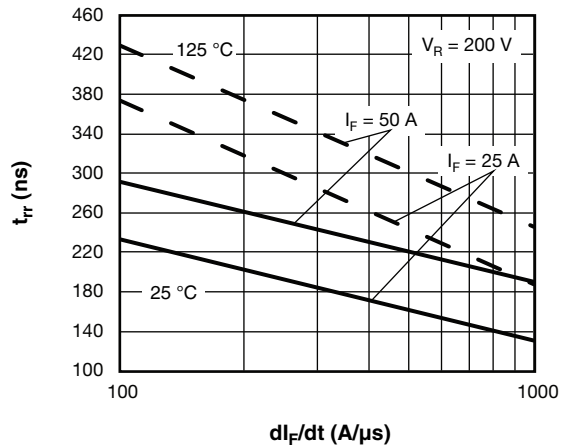

Fig. 7 - Typical Reverse Recovery Time vs. di_F/dt (Per Leg)

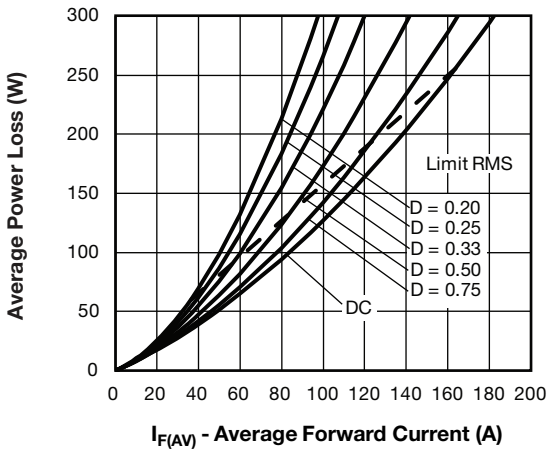

Fig. 6 - Forward Power Loss Characteristics (Per Leg)

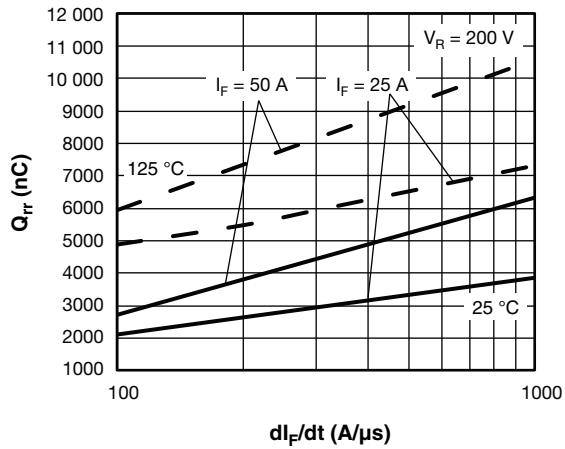

Fig. 8 - Typical Stored Charge vs. di_F/dt (Per Leg)

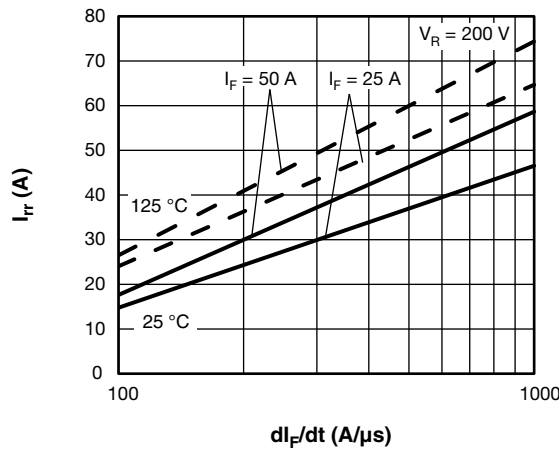

Fig. 9 - Typical Recovery Current vs. di_F/dt (Per Leg)

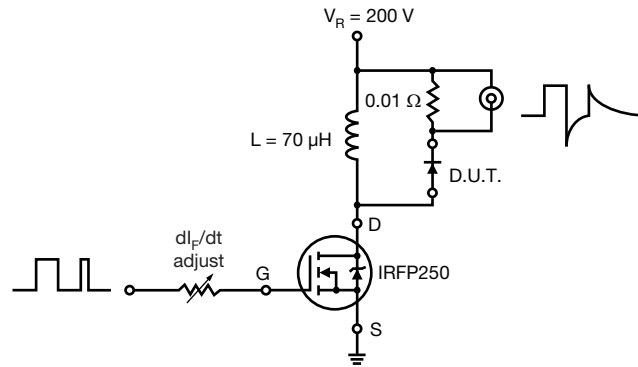
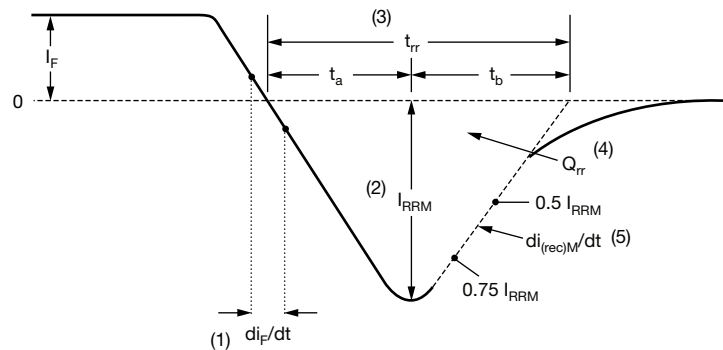

Fig. 10 - Reverse Recovery Parameter Test Circuit



- (1) di_F/dt - rate of change of current through zero crossing
- (2) I_{RRM} - peak reverse recovery current
- (3) t_{rr} - reverse recovery time measured from zero crossing point of negative going I_F to point where a line passing through $0.75 I_{RRM}$ and $0.50 I_{RRM}$ extrapolated to zero current.
- (4) Q_{rr} - area under curve defined by t_{rr} and I_{RRM}
- (5) $di_{(rec)M}/dt$ - peak rate of change of current during t_b portion of t_{rr}

$$Q_{rr} = \frac{t_{rr} \times I_{RRM}}{2}$$

Fig. 11 - Reverse Recovery Waveform and Definitions

ORDERING INFORMATION TABLE

| | | | | | | | |
|-------------|------------|-----------|----------|------------|----------|----------|-----------|
| Device code | VS- | UF | B | 170 | F | A | 60 |
| | ① | ② | ③ | ④ | ⑤ | ⑥ | ⑦ |

- 1** - Vishay Semiconductors product
- 2** - Ultrafast rectifier
- 3** - Ultrafast FRED Pt[®] diffused
- 4** - Current rating (170 = 170 A)
- 5** - Circuit configuration (two separate diodes, parallel pin-out)
- 6** - Package indicator (SOT-227 standard insulated base)
- 7** - Voltage rating (60 = 600 V)

| CIRCUIT CONFIGURATION | | |
|---------------------------------------|----------------------------|------------------------|
| CIRCUIT | CIRCUIT CONFIGURATION CODE | CIRCUIT DRAWING |
| Two separate diodes, parallel pin-out | F | <p>Lead Assignment</p> |

| LINKS TO RELATED DOCUMENTS | |
|----------------------------|--|
| Dimensions | www.vishay.com/doc?95423 |
| Packaging information | www.vishay.com/doc?95425 |



SOT-227 Generation 2

DIMENSIONS in millimeters (inches)



Note

- Controlling dimension: millimeter



Disclaimer

ALL PRODUCT, PRODUCT SPECIFICATIONS AND DATA ARE SUBJECT TO CHANGE WITHOUT NOTICE TO IMPROVE RELIABILITY, FUNCTION OR DESIGN OR OTHERWISE.

Vishay Intertechnology, Inc., its affiliates, agents, and employees, and all persons acting on its or their behalf (collectively, "Vishay"), disclaim any and all liability for any errors, inaccuracies or incompleteness contained in any datasheet or in any other disclosure relating to any product.

Vishay makes no warranty, representation or guarantee regarding the suitability of the products for any particular purpose or the continuing production of any product. To the maximum extent permitted by applicable law, Vishay disclaims (i) any and all liability arising out of the application or use of any product, (ii) any and all liability, including without limitation special, consequential or incidental damages, and (iii) any and all implied warranties, including warranties of fitness for particular purpose, non-infringement and merchantability.

Statements regarding the suitability of products for certain types of applications are based on Vishay's knowledge of typical requirements that are often placed on Vishay products in generic applications. Such statements are not binding statements about the suitability of products for a particular application. It is the customer's responsibility to validate that a particular product with the properties described in the product specification is suitable for use in a particular application. Parameters provided in datasheets and / or specifications may vary in different applications and performance may vary over time. All operating parameters, including typical parameters, must be validated for each customer application by the customer's technical experts. Product specifications do not expand or otherwise modify Vishay's terms and conditions of purchase, including but not limited to the warranty expressed therein.

Hyperlinks included in this datasheet may direct users to third-party websites. These links are provided as a convenience and for informational purposes only. Inclusion of these hyperlinks does not constitute an endorsement or an approval by Vishay of any of the products, services or opinions of the corporation, organization or individual associated with the third-party website. Vishay disclaims any and all liability and bears no responsibility for the accuracy, legality or content of the third-party website or for that of subsequent links.

Except as expressly indicated in writing, Vishay products are not designed for use in medical, life-saving, or life-sustaining applications or for any other application in which the failure of the Vishay product could result in personal injury or death. Customers using or selling Vishay products not expressly indicated for use in such applications do so at their own risk. Please contact authorized Vishay personnel to obtain written terms and conditions regarding products designed for such applications.

No license, express or implied, by estoppel or otherwise, to any intellectual property rights is granted by this document or by any conduct of Vishay. Product names and markings noted herein may be trademarks of their respective owners.