



## Aluminum Capacitors Axial Long-Life, DIN-Based

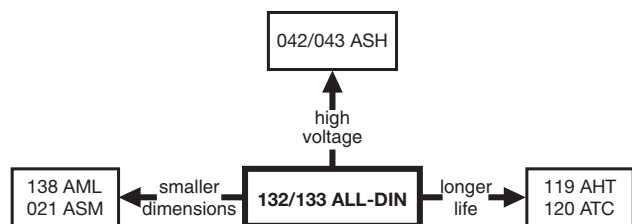

Fig. 1

QUICK REFERENCE DATA			
DESCRIPTION	VALUE		
Nominal case sizes (Ø D x L in mm)	6.5 x 18 and 8 x 18	10 x 18 and 10 x 25	10 x 30 to 21 x 38
Rated capacitance range, C <sub>R</sub>	1 µF to 4700 µF		
Tolerance on C <sub>R</sub>	-10 % to +50 %		
Rated voltage range, U <sub>R</sub>	10 V to 160 V		
Category temperature range	-40 °C to +85 °C		
Endurance test at 105 °C	2000 h	2000 h	-
Endurance test at 85 °C	6000 h	8000 h	8000 h
Useful life at 105 °C	3000 h	3000 h	-
Useful life at 85 °C	10 000 h	15 000 h	15 000 h
Useful life at 40 °C, 1.8 x I <sub>R</sub> applied	160 000 h	240 000 h	240 000 h
Shelf life at 0 V, 85 °C	500 h		
Based on sectional specification	IEC 60384-4/EN130300		
Climatic category IEC 60068	40/085/56		

SELECTION CHART FOR C <sub>R</sub> , U <sub>R</sub> , AND RELEVANT NOMINAL CASE SIZES (Ø D x L in mm)								
C <sub>R</sub> (µF)	U <sub>R</sub> (V)							
	10	16	25	40	63	100	160	250
1.0	-	-	-	-	-	6.5 x 18	-	-
2.2	-	-	-	-	-	6.5 x 18	-	-
4.7	-	-	-	-	6.5 x 18	6.5 x 18	-	-
10	-	-	-	-	6.5 x 18	8 x 18	-	-
	-	-	-	-	-	-	-	10 x 30 <sup>(1)</sup>
22	-	-	6.5 x 18	-	8 x 18	10 x 18	10 x 25	12.5 x 30 <sup>(1)</sup>
	-	-	-	-	-	-	10 x 30 <sup>(1)</sup>	-

**Note**

<sup>(1)</sup> For these CV-values see datasheet 041 - 043 ASH ([www.vishay.com/doc?28329](http://www.vishay.com/doc?28329))

**FEATURES**

- Long useful life: up to 15 000 h at 85 °C
- Taped versions up to case Ø 15 mm x 30 mm available for automatic insertion
- Charge and discharge proof
- Polarized aluminum electrolytic capacitors, non-solid electrolyte
- Axial leads, cylindrical aluminum case, insulated with a blue sleeve
- Mounting ring version not available in insulated form
- Material categorization: for definitions of compliance please see [www.vishay.com/doc?99912](http://www.vishay.com/doc?99912)



**RoHS  
COMPLIANT**

**APPLICATIONS**

- General industrial, power supplies, telecommunication, EDP
- Coupling, decoupling, timing; smoothing, filtering and buffering in SMPS
- For use where low mounting height is important
- Vibration and shock resistant

**MARKING**

The capacitors are marked (where possible) with the following information:

- Rated capacitance (in µF)
- Tolerance on rated capacitance, code letter in accordance with IEC 60062 (T for -10 % to +50 %)
- Rated voltage (in V)
- Upper category temperature (85 °C)
- Date code, in accordance with IEC 60062
- Code for factory of origin
- Name of manufacturer
- Negative terminal identification
- Series number (132 or 133)



SELECTION CHART FOR $C_R$ , $U_R$ , AND RELEVANT NOMINAL CASE SIZES ( $\varnothing D \times L$ in mm)								
$C_R$ ( $\mu F$ )	$U_R$ (V)							
	10	16	25	40	63	100	160	250
47	-	6.5 x 18	-	8 x 18	10 x 18	10 x 25	15 x 30 <sup>(1)</sup>	18 x 30 <sup>(1)</sup>
	-	-	-	-	-	10 x 30	-	-
68	-	-	-	-	10 x 30	12.5 x 30	15 x 30 <sup>(1)</sup>	18 x 38 <sup>(1)</sup>
100	-	8 x 18	-	10 x 18	10 x 30	15 x 30	18 x 30 <sup>(1)</sup>	21 x 38 <sup>(1)</sup>
150	-	-	-	12.5 x 30	15 x 30	18 x 30	18 x 38 <sup>(1)</sup>	-
220	8 x 18	10 x 18	10 x 25	12.5 x 30	15 x 30	18 x 38	21 x 38 <sup>(1)</sup>	-
	-	-	12.5 x 30	-	-	-	-	-
330	-	10 x 25	12.5 x 30	15 x 30	18 x 30	18 x 38	-	-
	-	12.5 x 30	-	-	-	-	-	-
470	12.5 x 30	10 x 25	12.5 x 30	15 x 30	18 x 38	21 x 38	-	-
	-	12.5 x 30	-	-	-	-	-	-
680	12.5 x 30	15 x 30	18 x 30	18 x 30	21 x 38	-	-	-
1000	15 x 30	15 x 30	18 x 30	18 x 38	21 x 38	-	-	-
1500	18 x 30	18 x 30	18 x 38	21 x 38	-	-	-	-
2200	18 x 30	18 x 38	21 x 38	21 x 38	-	-	-	-
3300	18 x 38	21 x 38	-	-	-	-	-	-
4700	21 x 38	21 x 38	-	-	-	-	-	-

**Note**

(1) For these CV-values see datasheet 041 - 043 ASH ([www.vishay.com/doc?28329](http://www.vishay.com/doc?28329))

**DIMENSIONS in millimeters AND AVAILABLE FORMS**

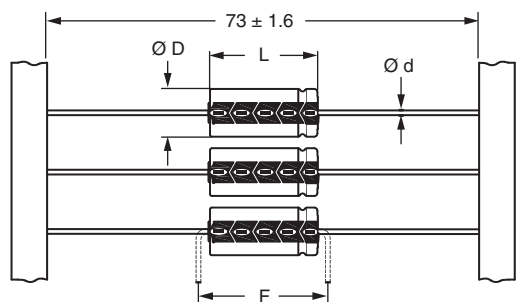

**Form BR:** Taped on reel  
Case  $\varnothing D \times L = 6.5 \text{ mm} \times 18 \text{ mm}$  to  $15 \text{ mm} \times 30 \text{ mm}$   
**Form BA:** Taped in box (ammopack)  
Case  $\varnothing D \times L = 6.5 \text{ mm} \times 18 \text{ mm}$  to  $10 \text{ mm} \times 25 \text{ mm}$

Fig. 2 - Forms BA and BR

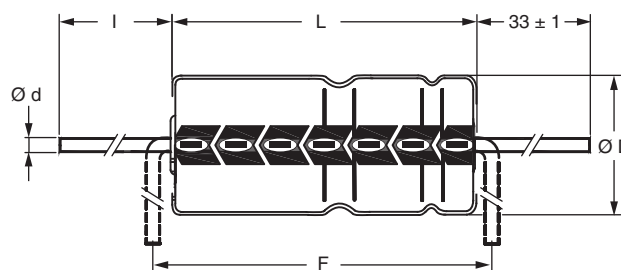

**Form AA:** Axial in box  
Case  $\varnothing D \times L = 10 \text{ mm} \times 30 \text{ mm}$  to  $21 \text{ mm} \times 38 \text{ mm}$

Fig. 3 - Form AA

Table 1

AXIAL; DIMENSIONS in millimeters, MASS, AND PACKAGING QUANTITIES										
NOMINAL CASE SIZE $\varnothing D \times L$	CASE CODE	AXIAL FORM AA, BA, AND BR					MASS (g)	PACKAGING QUANTITIES		
		$\varnothing d$	l	$\varnothing D_{max.}$	$L_{max.}$	$F_{min.}$		FORM AA	FORM BA	FORM BR
6.5 x 18	4	0.8	-	6.9	18.5	25	≈ 1.3	-	1000	1000
8 x 18	5	0.8	-	8.5	18.5	25	≈ 1.7	-	500	500
10 x 18	6	0.8	-	10.5	18.5	25	≈ 2.5	-	500	500
10 x 25	7	0.8	-	10.5	25.5	30	≈ 3.3	-	500	500
10 x 30	00	0.8	55 ± 1	10.5	30.5	35	≈ 4.8	340	-	500
12.5 x 30	01	0.8	55 ± 1	13.0	30.5	35	≈ 7.4	260	-	400
15 x 30	02	0.8	55 ± 1	15.5	30.5	35	≈ 11.7	200	-	250
18 x 30	03	0.8	55 ± 1	18.5	30.5	35	≈ 12.9	120	-	-
18 x 38	04	0.8	34 ± 1	18.5	39.5	44	≈ 19.0	125	-	-
21 x 38	05	0.8	34 ± 1	21.5	39.5	44	≈ 24.0	100	-	-

**Note**

• For detailed tape dimensions, please see [www.vishay.com/doc?28361](http://www.vishay.com/doc?28361).

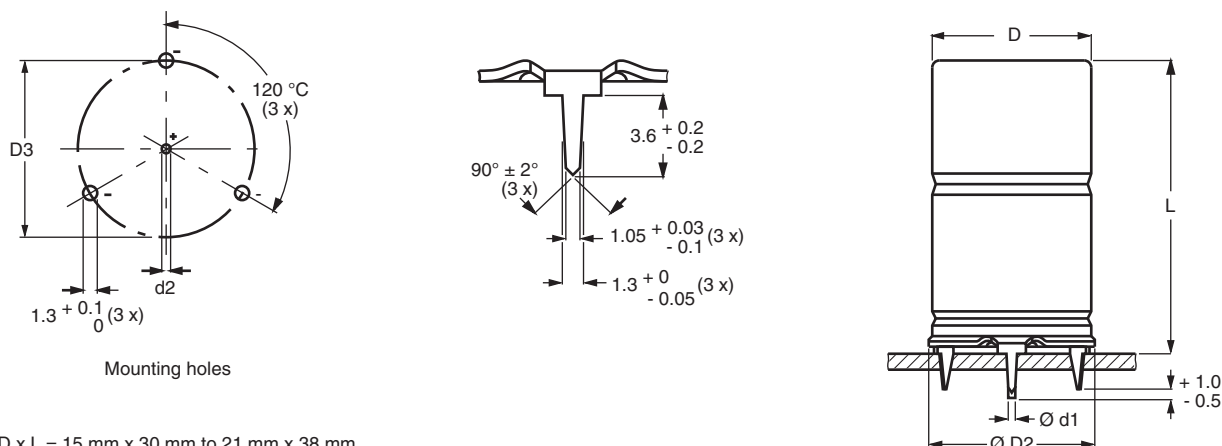

Mounting holes

Case  $\varnothing D \times L = 15 \text{ mm} \times 30 \text{ mm}$  to  $21 \text{ mm} \times 38 \text{ mm}$   
 Case not insulated (insulation on request)  
 Especially for applications with severe shocks and vibrations

Fig. 4 - Mounting hole diagram and outline; form MR: with mounting rings and pins

Table 2

MOUNTING RING; DIMENSIONS in millimeters, MASS, AND PACKAGING QUANTITIES									
NOMINAL CASE SIZE $\varnothing D \times L$	CASE CODE	MOUNTING RING: FORM MR						MASS (g)	PACKAGING QUANTITIES
		$\varnothing d1$	$\varnothing d2$	$\varnothing D_{max.}$	$\varnothing D2_{max.}$	D3	$L_{max.}$		
15 x 30	02	0.8	$1.0 + 0.4$	15.5	17.5	$16.5 \pm 0.2$	33	$\approx 11.7$	200
18 x 30	03	0.8	$1.0 + 0.4$	18.5	19.5	$18.5 \pm 0.2$	33	$\approx 12.9$	240
18 x 38	04	0.8	$1.0 + 0.4$	18.5	19.5	$18.5 \pm 0.2$	42	$\approx 19.0$	100
21 x 38	05	0.8	$1.0 + 0.4$	21.5	22.5	$21.5 \pm 0.2$	42	$\approx 24.0$	100

ELECTRICAL DATA	
SYMBOL	DESCRIPTION
$C_R$	Rated capacitance at 100 Hz, tolerance -10 %/+50 %
$I_R$	Rated RMS ripple current at 100 Hz, 85 °C
$I_{L5}$	Max. leakage current after 5 min at $U_R$
$\tan \delta$	Max. dissipation factor at 100 Hz
ESR	Equivalent series resistance at 100 Hz (calculated from $\tan \delta_{max.}$ and $C_R$ )
Z	Max. impedance at 10 kHz

Note

- Unless otherwise specified, all electrical values in Table 3 apply at  $T_{amb} = 20 \text{ °C}$ ,  $P = 86 \text{ kPa}$  to  $106 \text{ kPa}$ ,  $RH = 45 \text{ \%}$  to  $75 \text{ \%}$ .

ORDERING EXAMPLE

Electrolytic capacitor 132 series  
 100  $\mu\text{F}/40 \text{ V}$ ; -10 %/+50 %  
 Nominal case size:  $\varnothing 10 \text{ mm} \times 18 \text{ mm}$ ; form BR  
 Ordering code: MAL213227101E3  
 Former 12NC: 2222 132 27101



Table 3

ELECTRICAL DATA AND ORDERING INFORMATION												
U <sub>R</sub> (V)	C <sub>R</sub> 100 Hz (μF)	NOMINAL CASE SIZE Ø D x L (mm)	I <sub>R</sub> 100 Hz 85 °C (mA)	I <sub>L5</sub> 5 min (μA)	tan δ 100 Hz	ESR 100 Hz (Ω)	Z 10 kHz (Ω)	Z 100 kHz (Ω)	ORDERING CODE MAL2.....			
									IN BOX FORM AA	TAPED ON REEL FORM BR	TAPED IN BOX FORM BA	MOUNTING RING FORM MR
10	220	8 x 18	190	8.4	0.18	1.3	0.73	0.70	-	13224221E3	13234221E3	-
	470	12.5 x 30	350	9.4	0.18	0.61	0.26	0.60	13214471E3	13224471E3	-	-
	680	12.5 x 30	460	13.6	0.18	0.42	0.20	0.40	13214681E3	13224681E3	-	-
	1000	15 x 30	640	20	0.18	0.28	0.12	-	13214102E3	13224102E3	-	13244102E3
	1500	18 x 30	800	30	0.22	0.23	0.10	-	13214152E3	-	-	13244152E3
	2200	18 x 30	1100	44	0.22	0.16	0.09	-	13214222E3	-	-	13244222E3
	3300	18 x 38	1300	66	0.27	0.13	0.05	-	13214332E3	-	-	13244332E3
	4700	21 x 38	1800	94	0.27	0.09	0.05	-	13214472E3	-	-	13244472E3
16	47	6.5 x 18	95	5.5	0.14	4.7	2.6	2.2	-	13225479E3	13235479E3	-
	100	8 x 18	150	7.2	0.14	2.2	1.2	1.1	-	13225101E3	13235101E3	-
	220	10 x 18	250	11	0.14	1.0	0.55	0.55	-	13225221E3	13235221E3	-
	330	10 x 25	320	14.6	0.14	0.67	0.36	0.36	-	13290508E3	13290509E3	-
	330	12.5 x 30	320	10.6	0.14	0.67	0.36	0.60	13215331E3	13225331E3	-	-
	470	10 x 25	450	19	0.14	0.47	0.26	0.26	-	13290507E3	13290502E3	-
	470	12.5 x 30	450	15	0.14	0.47	0.26	0.40	13215471E3	13225471E3	-	-
	680	15 x 30	550	22	0.14	0.33	0.14	-	13215681E3	13225681E3	-	13245681E3
	1000	15 x 30	780	32	0.14	0.22	0.12	-	13215102E3	13225102E3	-	13245102E3
	1500	18 x 30	950	48	0.15	0.16	0.10	-	13215152E3	-	-	13245152E3
	2200	18 x 38	1300	70	0.15	0.11	0.06	-	13215222E3	-	-	13245222E3
	3300	21 x 38	1600	110	0.15	0.07	0.05	-	13215332E3	-	-	13245332E3
4700	21 x 38	2300	150	0.15	0.05	0.05	-	13215472E3	-	-	13245472E3	
25	22	6.5 x 18	60	5.1	0.11	8.0	4.1	2.9	-	13226229E3	13236229E3	-
	220	10 x 25	340	15	0.11	0.80	0.40	0.40	-	13290503E3	13290504E3	-
	220	12.5 x 30	340	11	0.11	0.80	0.40	0.60	13216221E3	13226221E3	-	-
	330	12.5 x 30	410	16.5	0.11	0.53	0.30	0.40	13216331E3	13226331E3	-	-
	470	12.5 x 30	560	24	0.11	0.37	0.20	-	13216471E3	13226471E3	-	-
	680	18 x 30	700	34	0.11	0.26	0.10	-	13216681E3	-	-	13246681E3
	1000	18 x 30	1000	50	0.11	0.17	0.10	-	13216102E3	-	-	13246102E3
	1500	18 x 38	1100	75	0.12	0.13	0.06	-	13216152E3	-	-	13246152E3
2200	21 x 38	1850	110	0.13	0.09	0.05	-	13216222E3	-	-	13246222E3	
40	47	8 x 18	120	7.8	0.09	3.0	1.6	1.4	-	13227479E3	13237479E3	-
	100	10 x 18	210	12	0.09	1.4	0.75	0.75	-	13227101E3	13237101E3	-
	150	10 x 25	310	16	0.09	0.95	0.50	0.50	-	13290511E3	13290512E3	-
	150	12.5 x 30	310	12	0.09	0.95	0.50	0.60	13217151E3	13227151E3	-	-
	220	12.5 x 30	410	17.5	0.09	0.65	0.34	0.40	13217221E3	13227221E3	-	-
	330	15 x 30	550	26	0.09	0.43	0.20	-	13217331E3	13227331E3	-	13247331E3
	470	15 x 30	700	38	0.09	0.30	0.16	-	13217471E3	13227471E3	-	13247471E3
	680	18 x 30	900	54	0.09	0.21	0.10	-	13217681E3	-	-	13247681E3
	1000	18 x 38	1200	80	0.09	0.14	0.08	-	13217102E3	-	-	13247102E3
	1500	21 x 38	1500	120	0.10	0.10	0.06	-	13217152E3	-	-	13247152E3
2200	21 x 38	1900	180	0.10	0.07	0.05	-	13217222E3	-	-	13247222E3	
63	4.7	6.5 x 18	38	4.6	0.07	24	12	5.0	-	13228478E3	13238478E3	-
	10	6.5 x 18	64	5.3	0.07	11	5.5	3.3	-	13228109E3	13238109E3	-
	22	8 x 18	100	6.8	0.07	5.1	2.5	2.1	-	13228229E3	13238229E3	-
	47	10 x 18	170	9.9	0.07	2.4	1.2	1.2	-	13228479E3	13238479E3	-
	68	10 x 25	210	12.6	0.07	1.6	0.81	0.60	-	13290513E3	13290514E3	-
	68	10 x 30	210	8.6	0.07	1.6	0.80	0.60	13218689E3	13228689E3	-	-
	100	10 x 30	300	12.6	0.07	1.1	0.60	0.40	13218101E3	13228101E3	-	-
	150	15 x 30	350	19	0.07	0.74	0.37	-	13218151E3	13228151E3	-	13248151E3
	220	15 x 30	520	28	0.07	0.50	0.25	-	13218221E3	13228221E3	-	13248221E3
	330	18 x 30	600	42	0.07	0.34	0.15	-	13218331E3	-	-	13248331E3
	470	18 x 38	970	59	0.07	0.24	0.12	-	13218471E3	-	-	13248471E3
	680	21 x 38	1000	86	0.07	0.16	0.08	-	13218681E3	-	-	13248681E3
1000	21 x 38	1600	130	0.07	0.11	0.06	-	13218102E3	-	-	13248102E3	



ELECTRICAL DATA AND ORDERING INFORMATION												
U <sub>R</sub> (V)	C <sub>R</sub> 100 Hz (μF)	NOMINAL CASE SIZE Ø D x L (mm)	I <sub>R</sub> 100 Hz 85 °C (mA)	I <sub>L5</sub> 5 min (μA)	tan δ 100 Hz	ESR 100 Hz (Ω)	Z 10 kHz (Ω)	Z 100 kHz (Ω)	ORDERING CODE MAL2.....			
									IN BOX FORM AA	TAPED ON REEL FORM BR	TAPED IN BOX FORM BA	MOUNTING RING FORM MR
100	1.0	6.5 x 18	20	4.0	0.06	95	45	6.0	-	13229108E3	13239108E3	-
	2.2	6.5 x 18	30	4.4	0.06	43	20	5.0	-	13229228E3	13239228E3	-
	4.7	6.5 x 18	48	4.9	0.06	20	9.6	4.0	-	13229478E3	13239478E3	-
	10	8 x 18	73	6.0	0.06	9.5	4.5	2.8	-	13229109E3	13239109E3	-
	22	10 x 18	130	8.4	0.06	4.3	2.0	1.3	-	13229229E3	13239229E3	-
	47	10 x 25	220	13.4	0.06	2.0	1.0	0.90	-	13290505E3	13290506E3	-
	47	10 x 30	220	9.4	0.06	2.0	1.0	0.90	13219479E3	13229479E3	-	-
	68	12.5 x 30	250	13.5	0.06	1.4	0.80	-	13219689E3	13229689E3	-	-
	100	15 x 30	380	20	0.06	0.95	0.50	-	13219101E3	13229101E3	-	13249101E3
	150	18 x 30	400	30	0.06	0.64	0.35	-	13219151E3	-	-	13249151E3
	220	18 x 38	660	44	0.06	0.43	0.20	-	13219221E3	-	-	13249221E3
	330	18 x 38	700	66	0.06	0.29	0.15	-	13219331E3	-	-	13249331E3
470	21 x 38	1200	94	0.06	0.20	0.10	-	13219471E3	-	-	13249471E3	
160	22	10 x 25	120	20	0.10	7.2	5.5	2.5	-	13390502E3	13390503E3	-

ADDITIONAL ELECTRICAL DATA				
PARAMETER	CONDITIONS	VALUE		
		AXIAL	MOUNTING RING	
<b>Voltage</b>				
Surge voltage	U <sub>R</sub> = 10 V to 160 V	U <sub>s</sub> ≤ 1.15 x U <sub>R</sub>		
Reverse voltage		U <sub>rev</sub> ≤ 1 V		
<b>Current</b>				
Leakage current	After 1 min:			
	case Ø D x L = 6.5 mm x 18 mm to 10 mm x 25 mm:			
	U <sub>R</sub> = 10 V to 100 V		I <sub>L1</sub> ≤ 0.01 C <sub>R</sub> x U <sub>R</sub> + 3 μA	
	U <sub>R</sub> = 160 V		I <sub>L1</sub> ≤ 50 μA	
	case Ø D x L = 10 mm x 30 mm to 21 mm x 38 mm:			
	U <sub>R</sub> = 10 V to 100 V		I <sub>L1</sub> ≤ 0.006 C <sub>R</sub> x U <sub>R</sub> + 3 μA	
	After 5 min:			
	case Ø D x L = 6.5 mm x 18 mm to 10 mm x 25 mm:			
	U <sub>R</sub> = 10 V to 100 V		I <sub>L5</sub> ≤ 0.002 C <sub>R</sub> x U <sub>R</sub> + 4 μA	
	U <sub>R</sub> = 160 V		I <sub>L5</sub> ≤ 20 μA	
case Ø D x L = 10 mm x 30 mm to 21 mm x 38 mm:				
U <sub>R</sub> = 10 V to 100 V		I <sub>L5</sub> ≤ 0.002 C <sub>R</sub> x U <sub>R</sub> + 4 μA		
<b>Inductance</b>				
Equivalent series inductance (ESL)	Case Ø D x L mm:			
	6.5 x 18		Typ. 15 nH	-
	8 x 18		Typ. 35 nH	-
	10 x 18		Typ. 69 nH	-
	10 x 25		Typ. 38 nH	-
	10 x 30		Typ. 38 nH	-
	12.5 x 30		Typ. 46 nH	-
	15 x 30		Typ. 48 nH	Typ. 39 nH
	18 x 30		Typ. 50 nH	Typ. 39 nH
	18 x 38		Typ. 54 nH	Typ. 39 nH
21 x 38		Typ. 59 nH	Typ. 39 nH	



**CAPACITANCE (C)**

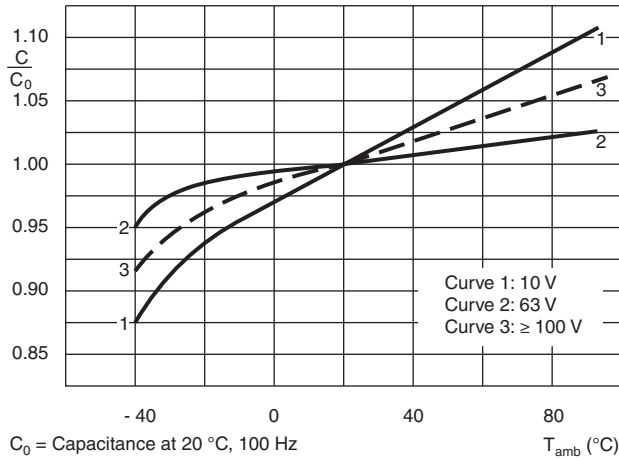

Fig. 5 - Typical multiplier of capacitance as a function of ambient temperature at 10 kHz

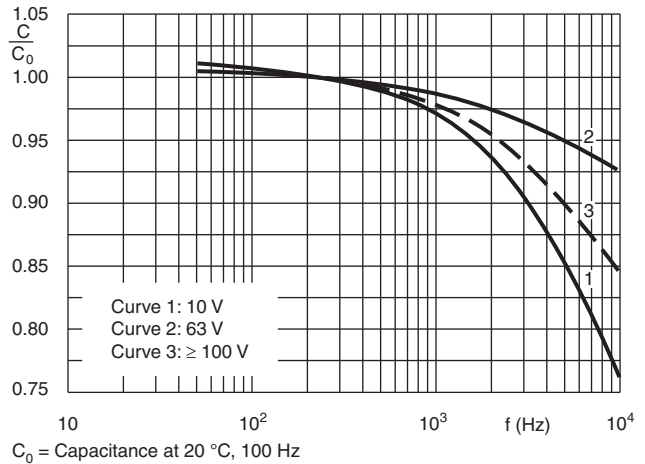

Fig. 6 - Typical multiplier of capacitance as a function of frequency

**DISSIPATION FACTOR (tan δ)**

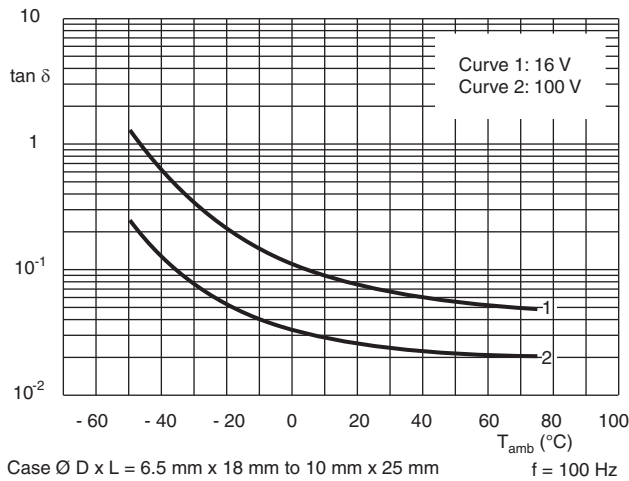

Fig. 7 - Typical tan δ as a function of ambient temperature

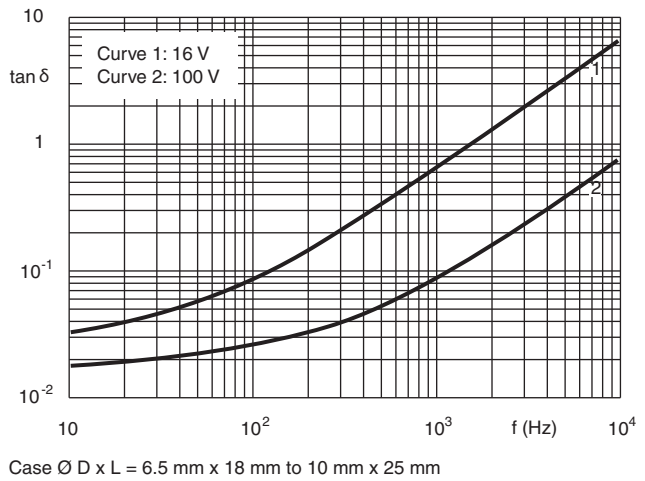

Fig. 8 - Typical tan δ as a function of frequency

**IMPEDANCE (Z)**

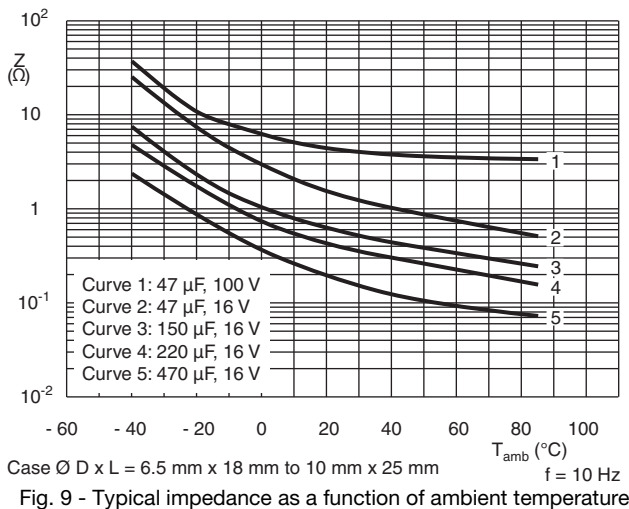

Fig. 9 - Typical impedance as a function of ambient temperature

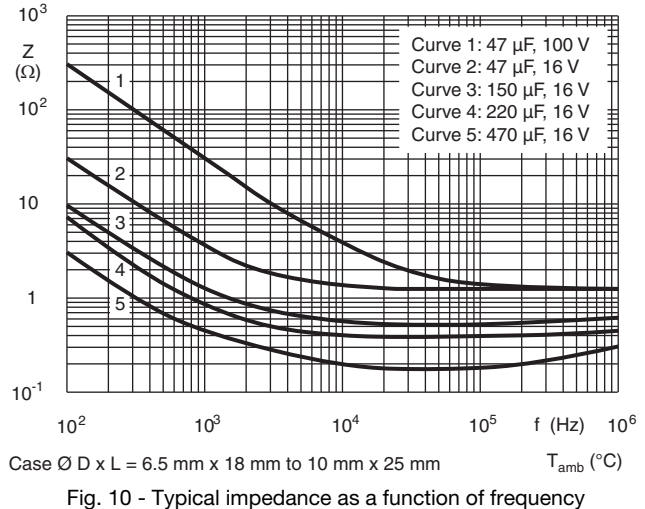
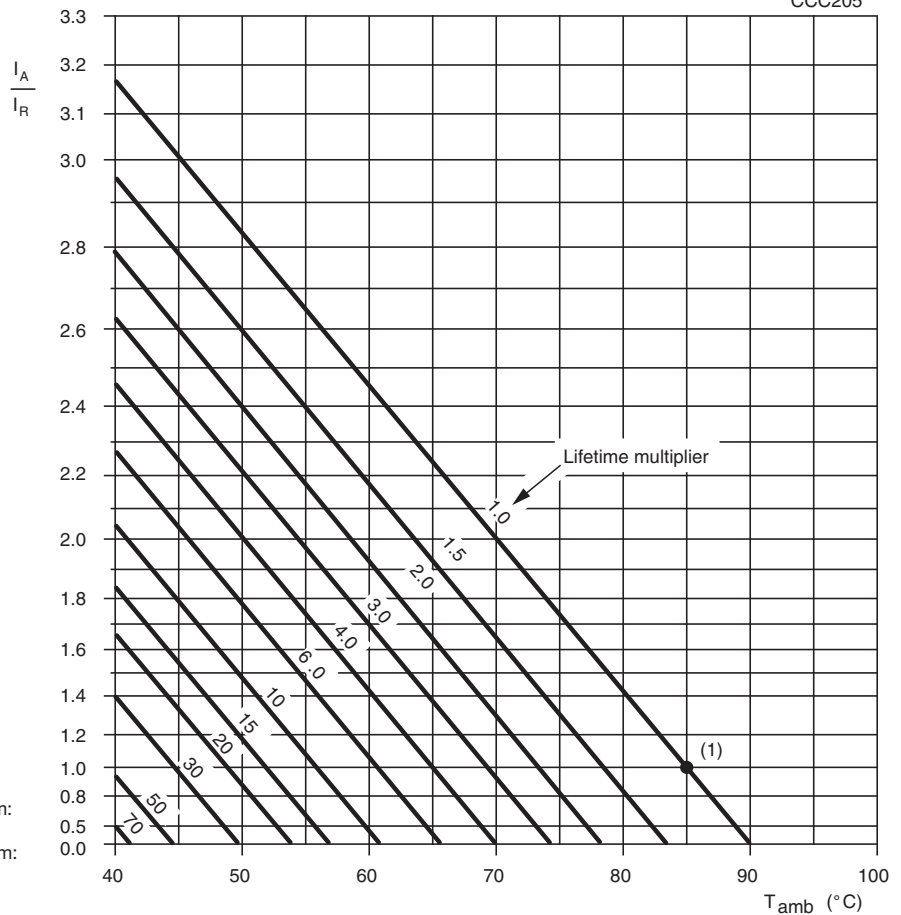

Fig. 10 - Typical impedance as a function of frequency



**RIPPLE CURRENT AND USEFUL LIFE**

CCC205



$I_A$  = Actual ripple current at 100 Hz  
 $I_R$  = Rated ripple current at 100 Hz, 85 °C

(1) Useful life at 85 °C and  $I_R$  applied:  
 Case  $\varnothing$  D x L = 6.5 mm x 18 mm to 8 mm x 18 mm:  
 10 000 h  
 Case  $\varnothing$  D x L = 10 mm x 18 mm to 21 mm x 38 mm:  
 15 000 h

Fig. 11 - Multiplier of useful life as a function of ambient temperature and ripple current load

Table 4

MULTIPLIER OF RIPPLE CURRENT ( $I_R$ ) AS A FUNCTION OF FREQUENCY			
FREQUENCY (Hz)	$I_R$ MULTIPLIER		
	$U_R = 10\text{ V AND }16\text{ V}$	$U_R = 25\text{ V AND }63\text{ V}$	$U_R = 100\text{ V TO }160\text{ V}$
50	0.95	0.90	0.85
100	1.00	1.00	1.00
300	1.07	1.12	1.20
1000	1.12	1.20	1.30
3000	1.15	1.25	1.35
$\geq 10\ 000$	1.20	1.30	1.40



Table 5

<b>TEST PROCEDURES AND REQUIREMENTS</b>			
<b>TEST</b>		<b>PROCEDURE (quick reference)</b>	<b>REQUIREMENTS</b>
<b>NAME OF TEST</b>	<b>REFERENCE</b>		
Endurance	IEC 60384-4/ EN 130300 subclause 4.13	$T_{amb} = 85\text{ }^{\circ}\text{C}$ ; $U_R$ applied; Case $\varnothing D \times L = 6.5\text{ mm} \times 18\text{ mm}$ to $8\text{ mm} \times 18\text{ mm}$ : 6000 h; Case $\varnothing D \times L = 10\text{ mm} \times 18\text{ mm}$ to $21\text{ mm} \times 38\text{ mm}$ : 8000 h	$U_R = 10\text{ V}$ to $160\text{ V}$ ; $\Delta C/C: \pm 15\%$ $\tan \delta \leq 1.3 \times \text{spec. limit}$ $Z \leq 2 \times \text{spec. limit}$ $I_{L5} \leq \text{spec. limit}$
Useful life	CECC 30301 subclause 1.8.1	$T_{amb} = 85\text{ }^{\circ}\text{C}$ ; $U_R$ and $I_R$ applied; Case $\varnothing D \times L = 6.5\text{ mm} \times 18\text{ mm}$ to $8\text{ mm} \times 18\text{ mm}$ : 10 000 h; Case $\varnothing D \times L = 10\text{ mm} \times 18\text{ mm}$ to $21\text{ mm} \times 38\text{ mm}$ : 15 000 h	$U_R = 10\text{ V}$ to $160\text{ V}$ ; $\Delta C/C: \pm 45\%$ $\tan \delta \leq 3 \times \text{spec. limit}$ $Z \leq 3 \times \text{spec. limit}$ $I_{L5} \leq \text{spec. limit}$ no short or open circuit total failure percentage: $\leq 1\%$
Shelf life (storage at high temperature)	IEC 60384-4/ EN 130300 subclause 4.17	$T_{amb} = 85\text{ }^{\circ}\text{C}$ ; no voltage applied; 500 h;  After test: $U_R$ to be applied for 30 min, 24 h to 48 h before measurement	$\Delta C/C$ , $\tan \delta$ , $Z$ : for requirements see "Endurance test" above  $I_{L5} \leq 2 \times \text{spec. limit}$





## **Disclaimer**

ALL PRODUCT, PRODUCT SPECIFICATIONS AND DATA ARE SUBJECT TO CHANGE WITHOUT NOTICE TO IMPROVE RELIABILITY, FUNCTION OR DESIGN OR OTHERWISE.

Vishay Intertechnology, Inc., its affiliates, agents, and employees, and all persons acting on its or their behalf (collectively, "Vishay"), disclaim any and all liability for any errors, inaccuracies or incompleteness contained in any datasheet or in any other disclosure relating to any product.

Vishay makes no warranty, representation or guarantee regarding the suitability of the products for any particular purpose or the continuing production of any product. To the maximum extent permitted by applicable law, Vishay disclaims (i) any and all liability arising out of the application or use of any product, (ii) any and all liability, including without limitation special, consequential or incidental damages, and (iii) any and all implied warranties, including warranties of fitness for particular purpose, non-infringement and merchantability.

Statements regarding the suitability of products for certain types of applications are based on Vishay's knowledge of typical requirements that are often placed on Vishay products in generic applications. Such statements are not binding statements about the suitability of products for a particular application. It is the customer's responsibility to validate that a particular product with the properties described in the product specification is suitable for use in a particular application. Parameters provided in datasheets and / or specifications may vary in different applications and performance may vary over time. All operating parameters, including typical parameters, must be validated for each customer application by the customer's technical experts. Product specifications do not expand or otherwise modify Vishay's terms and conditions of purchase, including but not limited to the warranty expressed therein.

Except as expressly indicated in writing, Vishay products are not designed for use in medical, life-saving, or life-sustaining applications or for any other application in which the failure of the Vishay product could result in personal injury or death. Customers using or selling Vishay products not expressly indicated for use in such applications do so at their own risk. Please contact authorized Vishay personnel to obtain written terms and conditions regarding products designed for such applications.

No license, express or implied, by estoppel or otherwise, to any intellectual property rights is granted by this document or by any conduct of Vishay. Product names and markings noted herein may be trademarks of their respective owners.