

Z-Diodes

Features

- Very sharp reverse characteristic
- Low reverse current level
- Available with tighter tolerances
- Very high stability
- Low noise
- Silicon Epitaxial Planar
- High reliability

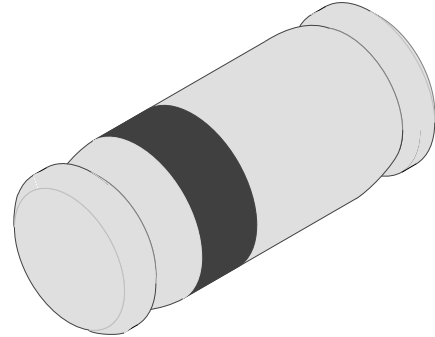

94 9371

Applications

Voltage stabilization

Order Instruction

Type	Ordering Code	Remarks
TLZ2V4	TLZ2V4-GS08	Tape and Reel (2.500 pcs)
	TLZ2V4-GS18	Tape and Reel (10.000 pcs)

Absolute Maximum Ratings

$T_j = 25^\circ\text{C}$

Parameter	Test Conditions	Type	Symbol	Value	Unit
Power dissipation	$R_{thJA} \leq 300\text{K/W}$		P_V	500	mW
Z-current			I_Z	P_V/V_Z	mA
Junction temperature			T_j	175	$^\circ\text{C}$
Storage temperature range			T_{stg}	-65...+175	$^\circ\text{C}$

Maximum Thermal Resistance

$T_j = 25^\circ\text{C}$

Parameter	Test Conditions	Symbol	Value	Unit
Junction ambient	on PC board 50 mmx50 mmx1.6 mm	R_{thJA}	500	K/W

Electrical Characteristics

$T_j = 25^\circ\text{C}$

Parameter	Test Conditions	Type	Symbol	Min	Typ	Max	Unit
Forward voltage	$I_F=200\text{mA}$		V_F			1.5	V

Type	V _{Zmin.} (V)	V _{Zmax.} (V)	at I _Z (mA)	Z _{Zmax.} (Ω)	at I _Z (mA)	Z _{ZKmax.} (Ω)	at I _Z (mA)	I _{Rmax.} (μA)	at V _R (V)
TLZ2V4	2.330	2.630	20	100	20	2000	1	120	1.0
TLZ2V4A	2.330	2.520	20	100	20	2000	1	120	1.0
TLZ2V4B	2.430	2.630	20	100	20	2000	1	120	1.0
TLZ2V7	2.540	2.910	20	100	20	1000	1	100	1.0
TLZ2V7A	2.540	2.750	20	100	20	1000	1	100	1.0
TLZ2V7B	2.690	2.910	20	100	20	1000	1	100	1.0
TLZ3V0	2.850	3.220	20	80	20	1000	1	50	1.0
TLZ3V0A	2.850	3.070	20	80	20	1000	1	50	1.0
TLZ3V0B	3.010	3.220	20	80	20	1000	1	50	1.0
TLZ3V3	3.160	3.530	20	70	20	1000	1	20	1.0
TLZ3V3A	3.160	3.380	20	70	20	1000	1	20	1.0
TLZ3V3B	3.320	3.530	20	70	20	1000	1	20	1.0
TLZ3V6	3.455	3.845	20	60	20	1000	1	10	1.0
TLZ3V6A	3.455	3.695	20	60	20	1000	1	10	1.0
TLZ3V6B	3.600	3.845	20	60	20	1000	1	10	1.0
TLZ3V9	3.74	4.16	20	50	20	1000	1	5	1.0
TLZ3V9A	3.74	4.01	20	50	20	1000	1	5	1.0
TLZ3V9B	3.89	4.16	20	50	20	1000	1	5	1.0
TLZ4V3	4.04	4.57	20	40	20	1000	1	5	1.0
TLZ4V3A	4.04	4.29	20	40	20	1000	1	5	1.0
TLZ4V3B	4.17	4.43	20	40	20	1000	1	5	1.0
TLZ4V3C	4.30	4.57	20	40	20	1000	1	5	1.0
TLZ4V7	4.44	4.93	20	25	20	900	1	5	1.0
TLZ4V7A	4.44	4.68	20	25	20	900	1	5	1.0
TLZ4V7B	4.55	4.80	20	25	20	900	1	5	1.0
TLZ4V7C	4.68	4.93	20	25	20	900	1	5	1.0
TLZ5V1	4.81	5.37	20	20	20	800	1	5	1.5
TLZ5V1A	4.81	5.07	20	20	20	800	1	5	1.5
TLZ5V1B	4.94	5.20	20	20	20	800	1	5	1.5
TLZ5V1C	5.09	5.37	20	20	20	800	1	5	1.5
TLZ5V6	5.28	5.91	20	13	20	500	1	5	2.5
TLZ5V6A	5.28	5.55	20	13	20	500	1	5	2.5
TLZ5V6B	5.45	5.73	20	13	20	500	1	5	2.5
TLZ5V6C	5.61	5.91	20	13	20	500	1	5	2.5
TLZ6V2	5.78	6.44	20	10	20	300	1	5	3.0
TLZ6V2A	5.78	6.09	20	10	20	300	1	5	3.0
TLZ6V2B	5.96	6.27	20	10	20	300	1	5	3.0
TLZ6V2C	6.12	6.44	20	10	20	300	1	5	3.0
TLZ6V8	6.29	7.01	20	8	20	150	0.5	2	3.5
TLZ6V8A	6.29	6.63	20	8	20	150	0.5	2	3.5
TLZ6V8B	6.49	6.83	20	8	20	150	0.5	2	3.5
TLZ6V8C	6.66	7.01	20	8	20	150	0.5	2	3.5



Type	V _{Zmin.} (V)	V _{Zmax.} (V)	at I _Z (mA)	Z _{Zmax.} (Ω)	at I _Z (mA)	Z _{ZKmax.} (Ω)	at I _Z (mA)	I _{Rmax.} (μA)	at V _R (V)
TLZ7V5	6.85	7.67	20	8	20	120	0.5	0.5	4.0
TLZ7V5A	6.85	7.22	20	8	20	120	0.5	0.5	4.0
TLZ7V5B	7.07	7.45	20	8	20	120	0.5	0.5	4.0
TLZ7V5C	7.29	7.67	20	8	20	120	0.5	0.5	4.0
TLZ8V2	7.53	8.45	20	8	20	120	0.5	0.5	5.0
TLZ8V2A	7.53	7.92	20	8	20	120	0.5	0.5	5.0
TLZ8V2B	7.78	8.19	20	8	20	120	0.5	0.5	5.0
TLZ8V2C	8.03	8.45	20	8	20	120	0.5	0.5	5.0
TLZ9V1	8.29	9.30	20	8	20	120	0.5	0.5	6.0
TLZ9V1A	8.29	8.73	20	8	20	120	0.5	0.5	6.0
TLZ9V1B	8.57	9.01	20	8	20	120	0.5	0.5	6.0
TLZ9V1C	8.83	9.30	20	8	20	120	0.5	0.5	6.0
TLZ10	9.12	10.44	20	8	20	120	0.5	0.2	7.0
TLZ10A	9.12	9.59	20	8	20	120	0.5	0.2	7.0
TLZ10B	9.41	9.90	20	8	20	120	0.5	0.2	7.0
TLZ10C	9.70	10.20	20	8	20	120	0.5	0.2	7.0
TLZ10D	9.94	10.44	20	8	20	120	0.5	0.2	7.0
TLZ11	10.18	11.38	10	10	10	120	0.5	0.2	8.0
TLZ11A	10.18	10.71	10	10	10	120	0.5	0.2	8.0
TLZ11B	10.50	11.05	10	10	10	120	0.5	0.2	8.0
TLZ11C	10.82	11.38	10	10	10	120	0.5	0.2	8.0
TLZ12	11.13	12.35	10	12	10	110	0.5	0.2	9.0
TLZ12A	11.13	11.71	10	12	10	110	0.5	0.2	9.0
TLZ12B	11.44	12.03	10	12	10	110	0.5	0.2	9.0
TLZ12C	11.74	12.35	10	12	10	110	0.5	0.2	9.0
TLZ13	12.11	13.66	10	14	10	110	0.5	0.2	10
TLZ13A	12.11	12.75	10	14	10	110	0.5	0.2	10
TLZ13B	12.55	13.21	10	14	10	110	0.5	0.2	10
TLZ13C	12.99	13.66	10	14	10	110	0.5	0.2	10
TLZ15	13.44	15.09	10	16	10	110	0.5	0.2	11
TLZ15A	13.44	14.13	10	16	10	110	0.5	0.2	11
TLZ15B	13.89	14.62	10	16	10	110	0.5	0.2	11
TLZ15C	14.35	15.09	10	16	10	110	0.5	0.2	11
TLZ16	14.80	16.51	10	18	10	150	0.5	0.2	12
TLZ16A	14.80	15.57	10	18	10	150	0.5	0.2	12
TLZ16B	15.25	16.04	10	18	10	150	0.5	0.2	12
TLZ16C	15.69	16.51	10	18	10	150	0.5	0.2	12
TLZ18	16.22	18.33	10	23	10	150	0.5	0.2	13
TLZ18A	16.22	17.06	10	23	10	150	0.5	0.2	13
TLZ18B	16.82	17.70	10	23	10	150	0.5	0.2	13
TLZ18C	17.42	18.33	10	23	10	150	0.5	0.2	13
TLZ20	18.02	20.72	10	28	10	200	0.5	0.2	15
TLZ20A	18.02	18.96	10	28	10	200	0.5	0.2	15
TLZ20B	18.63	19.59	10	28	10	200	0.5	0.2	15
TLZ20C	19.23	20.22	10	28	10	200	0.5	0.2	15
TLZ20D	19.72	20.72	10	28	10	200	0.5	0.2	15

Type	V _{Zmin.} (V)	V _{Zmax.} (V)	at I _Z (mA)	Z _{Zmax.} (Ω)	at I _Z (mA)	Z _{ZKmax.} (Ω)	at I _Z (mA)	I _{Rmax.} (μA)	at V _R (V)
TLZ22	20.15	22.63	5	30	5	200	0.5	0.2	17
TLZ22A	20.15	21.20	5	30	5	200	0.5	0.2	17
TLZ22B	20.64	21.71	5	30	5	200	0.5	0.2	17
TLZ22C	21.08	22.17	5	30	5	200	0.5	0.2	17
TLZ22D	21.52	22.63	5	30	5	200	0.5	0.2	17
TLZ24	22.05	24.85	5	35	5	200	0.5	0.2	19
TLZ24A	22.05	23.18	5	35	5	200	0.5	0.2	19
TLZ24B	22.61	23.77	5	35	5	200	0.5	0.2	19
TLZ24C	23.12	24.31	5	35	5	200	0.5	0.2	19
TLZ24D	23.63	24.85	5	35	5	200	0.5	0.2	19
TLZ27	24.26	27.64	5	45	5	250	0.5	0.2	21
TLZ27A	24.26	25.52	5	45	5	250	0.5	0.2	21
TLZ27B	24.97	26.26	5	45	5	250	0.5	0.2	21
TLZ27C	25.63	26.95	5	45	5	250	0.5	0.2	21
TLZ27D	26.29	27.64	5	45	5	250	0.5	0.2	21
TLZ30	26.99	30.51	5	55	5	250	0.5	0.2	23
TLZ30A	26.99	28.39	5	55	5	250	0.5	0.2	23
TLZ30B	27.70	29.13	5	55	5	250	0.5	0.2	23
TLZ30C	28.36	29.82	5	55	5	250	0.5	0.2	23
TLZ30D	29.02	30.51	5	55	5	250	0.5	0.2	23
TLZ33	29.68	33.11	5	65	5	250	0.5	0.2	25
TLZ33A	29.68	31.22	5	65	5	250	0.5	0.2	25
TLZ33B	30.32	31.88	5	65	5	250	0.5	0.2	25
TLZ33C	30.90	32.50	5	65	5	250	0.5	0.2	25
TLZ33D	31.49	33.11	5	65	5	250	0.5	0.2	25
TLZ36	32.14	35.77	5	75	5	250	0.5	0.2	27
TLZ36A	32.14	33.79	5	75	5	250	0.5	0.2	27
TLZ36B	32.79	34.49	5	75	5	250	0.5	0.2	27
TLZ36C	33.40	35.13	5	75	5	250	0.5	0.2	27
TLZ36D	34.01	35.77	5	75	5	250	0.5	0.2	27
TLZ39	34.68	40.80	5	85	5	250	0.5	0.2	30
TLZ39A	34.68	36.47	5	85	5	250	0.5	0.2	30
TLZ39B	35.36	37.19	5	85	5	250	0.5	0.2	30
TLZ39C	36.00	37.85	5	85	5	250	0.5	0.2	30
TLZ39D	36.63	38.52	5	85	5	250	0.5	0.2	30
TLZ39E	37.36	39.29	5	85	5	250	0.5	0.2	30
TLZ39F	38.14	40.11	5	85	5	250	0.5	0.2	30
TLZ39G	38.94	40.80	5	85	5	250	0.5	0.2	30
TLZ43	40.00	45.00	5	90	5	–	–	0.2	33
TLZ47	44.00	49.00	5	90	5	–	–	0.2	36
TLZ51	48.00	54.00	5	100	5	–	–	0.2	39
TLZ56	53.00	60.00	5	100	5	–	–	0.2	43

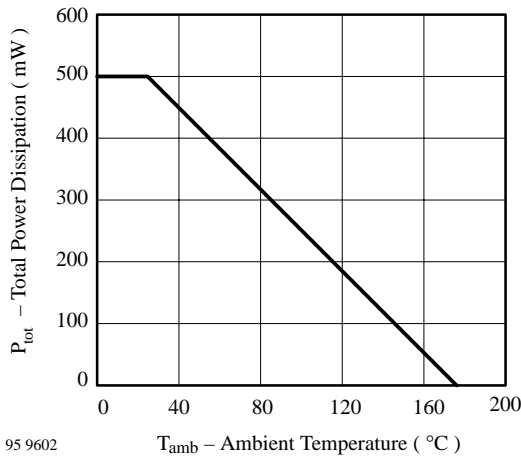
Characteristics ($T_j = 25^\circ\text{C}$ unless otherwise specified)

95 9602

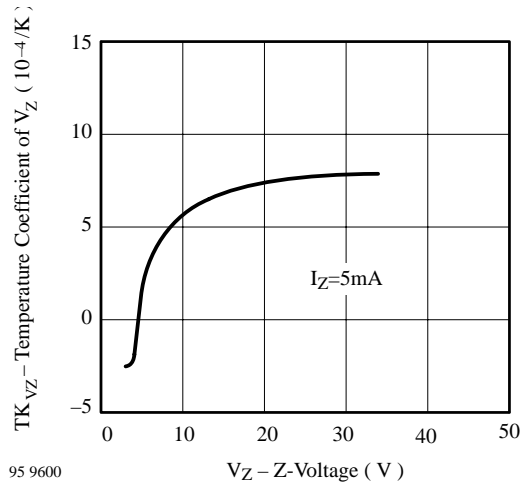
Figure 1. Total Power Dissipation vs. Ambient Temperature

95 9600

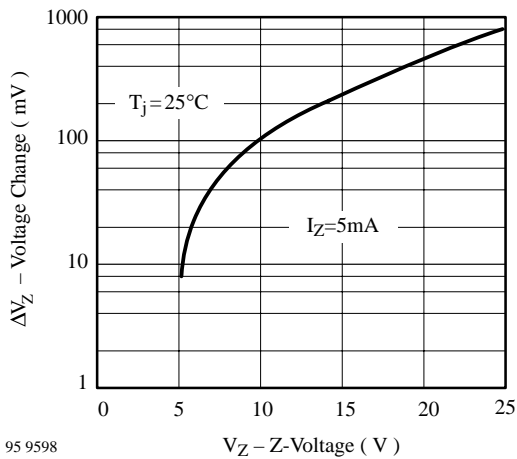
Figure 4. Temperature Coefficient of V_Z vs. Z-Voltage

95 9598

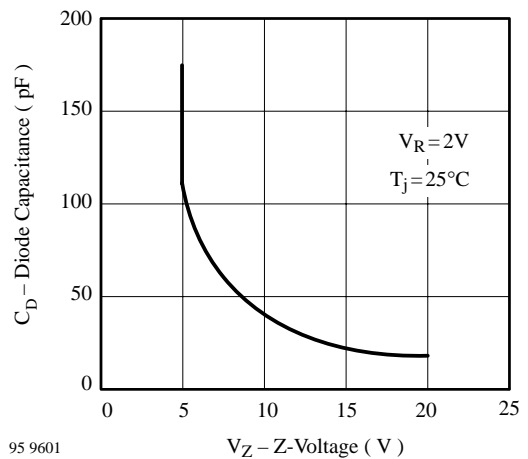
Figure 2. Typical Change of Working Voltage under Operating Conditions at $T_{amb}=25^\circ\text{C}$

95 9601

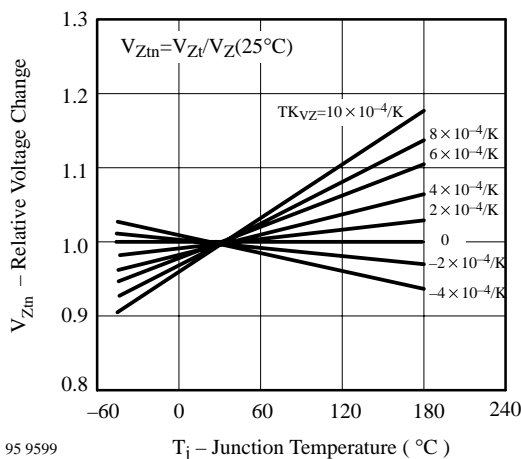
Figure 5. Diode Capacitance vs. Z-Voltage

95 9599

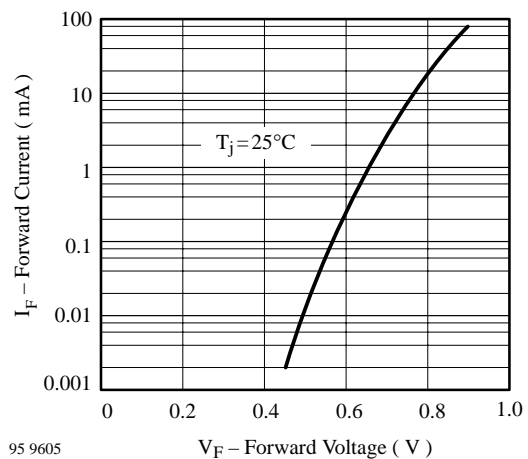
Figure 3. Typical Change of Working Voltage vs. Junction Temperature

95 9605

Figure 6. Forward Current vs. Forward Voltage

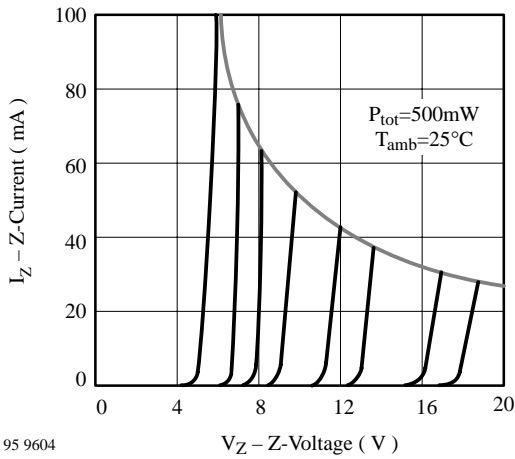

95 9604

Figure 7. Z-Current vs. Z-Voltage

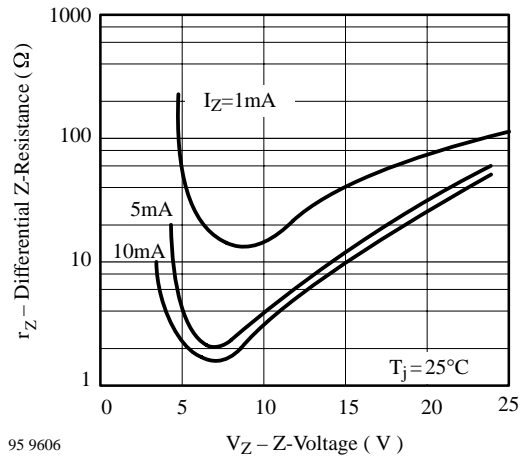

95 9606

Figure 9. Differential Z-Resistance vs. Z-Voltage

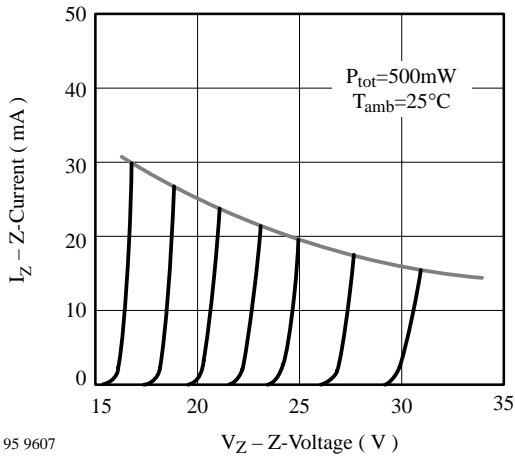

95 9607

Figure 8. Z-Current vs. Z-Voltage

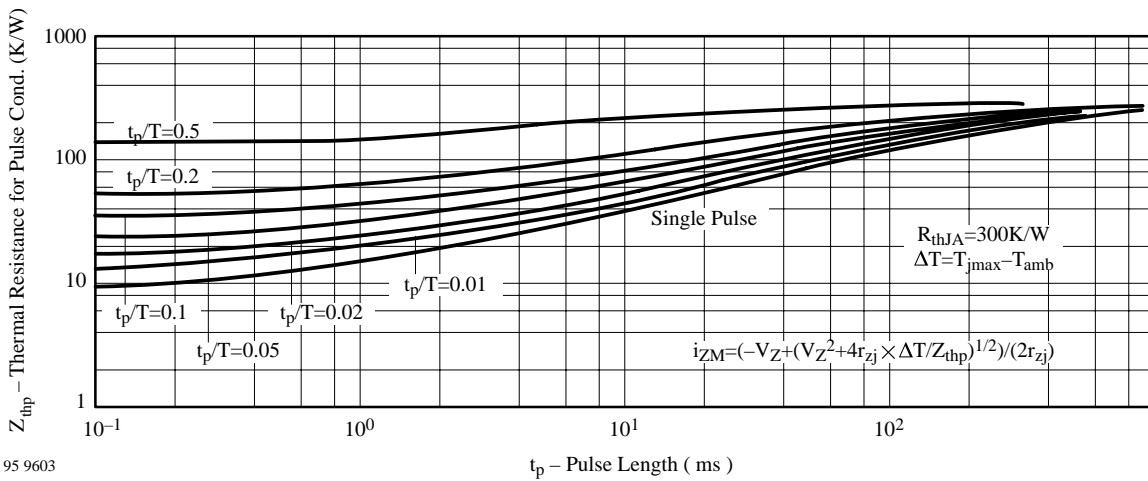

95 9603

Figure 10. Thermal Response

Dimensions in mm

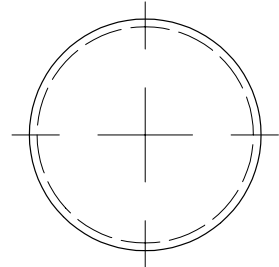
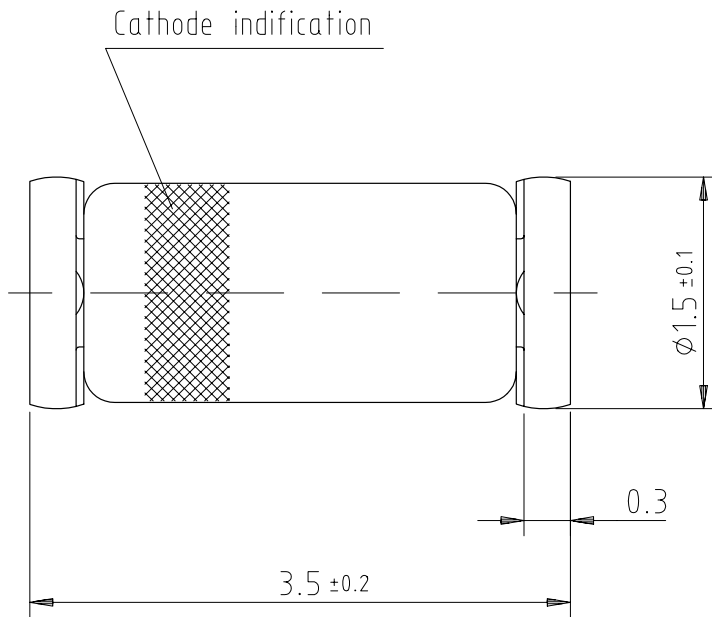

Glass case
 Mini MELF / SOD 80
 JEDEC DO 213 AA

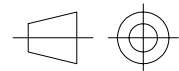

technical drawings
 according to DIN
 specifications

96 12070

Ozone Depleting Substances Policy Statement

It is the policy of **Vishay Semiconductor GmbH** to

1. Meet all present and future national and international statutory requirements.
2. Regularly and continuously improve the performance of our products, processes, distribution and operating systems with respect to their impact on the health and safety of our employees and the public, as well as their impact on the environment.

It is particular concern to control or eliminate releases of those substances into the atmosphere which are known as ozone depleting substances (ODSs).

The Montreal Protocol (1987) and its London Amendments (1990) intend to severely restrict the use of ODSs and forbid their use within the next ten years. Various national and international initiatives are pressing for an earlier ban on these substances.

Vishay Semiconductor GmbH has been able to use its policy of continuous improvements to eliminate the use of ODSs listed in the following documents.

1. Annex A, B and list of transitional substances of the Montreal Protocol and the London Amendments respectively
2. Class I and II ozone depleting substances in the Clean Air Act Amendments of 1990 by the Environmental Protection Agency (EPA) in the USA
3. Council Decision 88/540/EEC and 91/690/EEC Annex A, B and C (transitional substances) respectively.

Vishay Semiconductor GmbH can certify that our semiconductors are not manufactured with ozone depleting substances and do not contain such substances.

We reserve the right to make changes to improve technical design and may do so without further notice.

Parameters can vary in different applications. All operating parameters must be validated for each customer application by the customer. Should the buyer use Vishay-Telefunken products for any unintended or unauthorized application, the buyer shall indemnify Vishay-Telefunken against all claims, costs, damages, and expenses, arising out of, directly or indirectly, any claim of personal damage, injury or death associated with such unintended or unauthorized use.

Vishay Semiconductor GmbH, P.O.B. 3535, D-74025 Heilbronn, Germany
Telephone: 49 (0) 7131 67 2831, Fax number: 49 (0) 7131 67 2423