

**Silicon Switching Diodes**

- High-speed, high-voltage switching applications

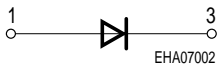
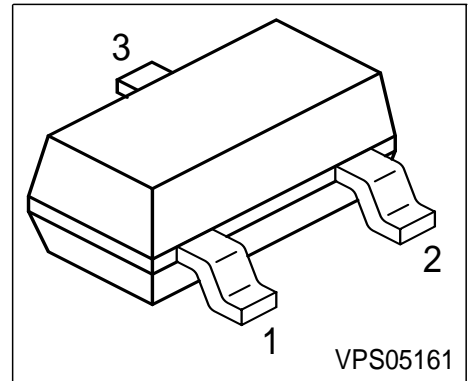

Type	Marking	Pin Configuration			Package
		1 = A	2 = n.c.	3 = C	
BAS19	JPs	1 = A	2 = n.c.	3 = C	SOT23
BAS20	JRs	1 = A	2 = n.c.	3 = C	SOT23
BAS21	JSs	1 = A	2 = n.c.	3 = C	SOT23

**Maximum Ratings**

Parameter	Symbol	Value	Unit
Diode reverse voltage	$V_R$		V
BAS19		100	
BAS20		150	
BAS21		200	
Peak reverse voltage-	$V_{RM}$		
BAS19		120	
BAS20		200	
BAS21		250	
Forward current	$I_F$	250	mA
Peak forward current	$I_{FM}$	625	
Total power dissipation $T_S = 70\text{ °C}$	$P_{tot}$	350	mW
Junction temperature	$T_j$	150	°C
Storage temperature	$T_{stg}$	-65 ... 150	

**Thermal Resistance**

Parameter	Symbol	Value	Unit
Junction - soldering point <sup>1)</sup>	$R_{thJS}$	≤ 230	K/W

<sup>1)</sup>For calculation of  $R_{thJA}$  please refer to Application Note Thermal Resistance

**Electrical Characteristics** at  $T_A = 25^\circ\text{C}$ , unless otherwise specified

Parameter	Symbol	Values			Unit
		min.	typ.	max.	
<b>DC Characteristics</b>					
Breakdown voltage $I_{(BR)} = 100 \mu\text{A}$ , BAS19 $I_{(BR)} = 100 \mu\text{A}$ , BAS20 $I_{(BR)} = 100 \mu\text{A}$ , BAS21	$V_{(BR)}$	120 200 250	- - -	- - -	V
Reverse current $V_R = V_{Rmax}$ $V_R = V_{Rmax}$ , $T_A = 150^\circ\text{C}$	$I_R$	- -	- -	0.1 100	$\mu\text{A}$
Forward voltage $I_F = 100 \text{ mA}$ $I_F = 200 \text{ mA}$	$V_F$	- -	- -	1 1.25	V

**AC Characteristics**

Diode capacitance- $V_R = 0 \text{ V}$ , $f = 1 \text{ MHz}$	$C_T$	-	-	5	$\mu\text{F}$
Reverse recovery time $I_F = 30 \text{ mA}$ , $I_R = 30 \text{ mA}$ , measured at $I_R = 3 \text{ mA}$ , $R_L = 100 \Omega$	$t_{rr}$	-	-	50	ns

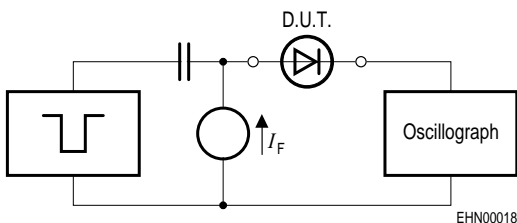
**Test circuit for reverse recovery time**

Pulse generator:  $t_p = 1 \mu\text{s}$ ,  $D = 0.05$ ,  
 $t_r = 0.6 \text{ ns}$ ,  $R_i = 50 \Omega$

Oscilloscope:  $R = 50 \Omega$ ,  $t_f = 0.35 \text{ ns}$ ,  $C \leq 1 \text{ pF}$

**Reverse current  $I_R = f(T_A)$**

$V_R =$  Parameter

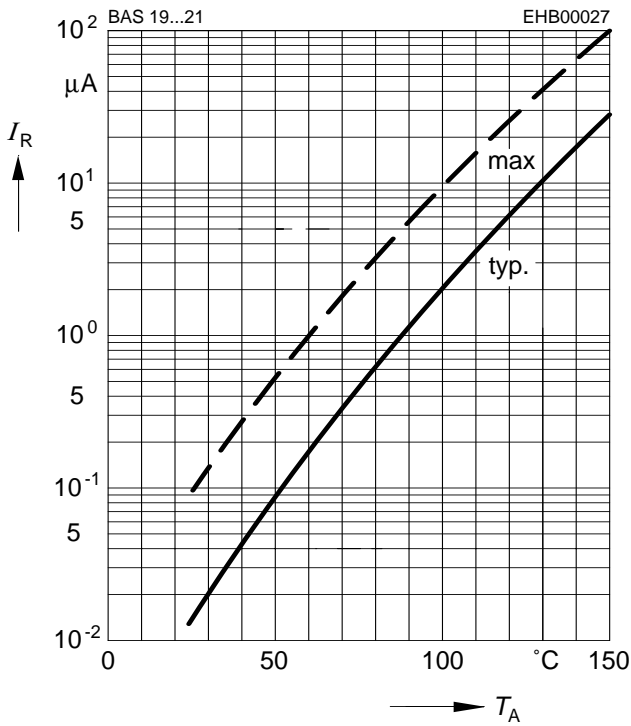

**Forward Voltage  $V_F = f(T_A)$**

$I_F =$  Parameter

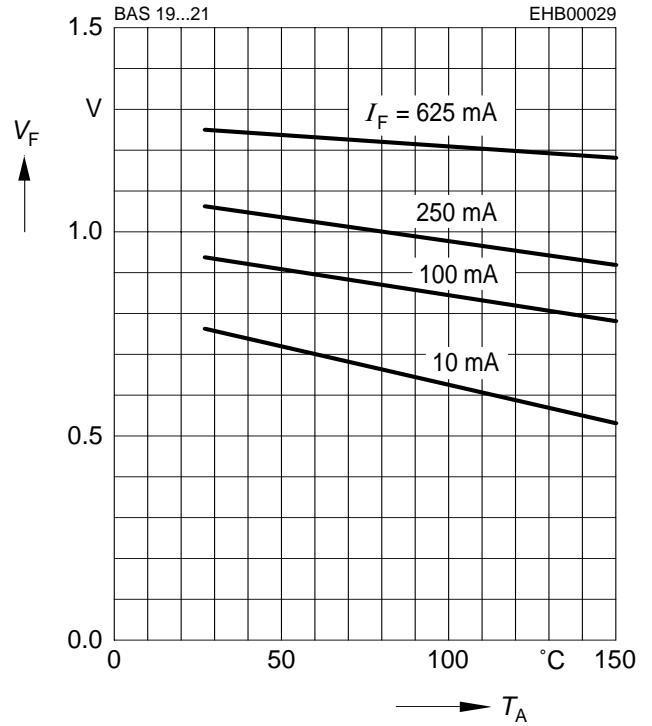

**Forward current  $I_F = f(V_F)$**

$T_A = 25\text{ °C}$

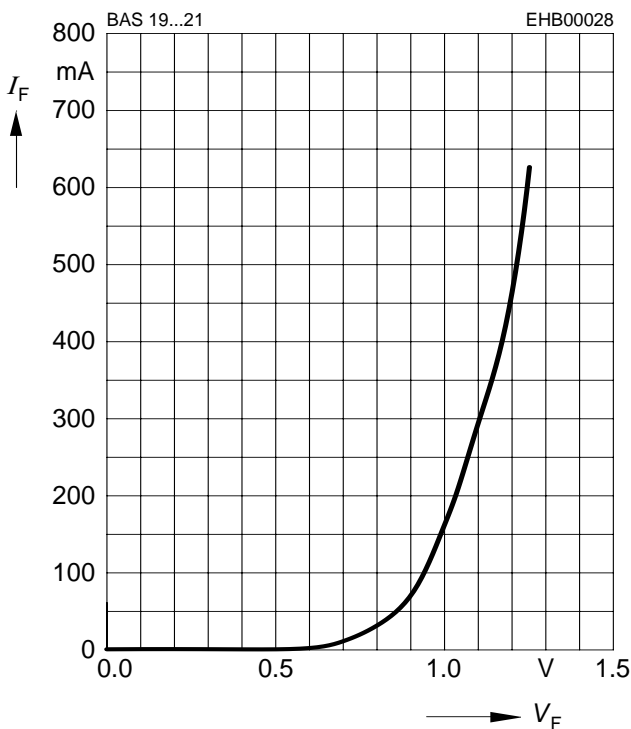

**Peak forward current  $I_{FM} = f(t_p)$**

$T_A = 25\text{ °C}$

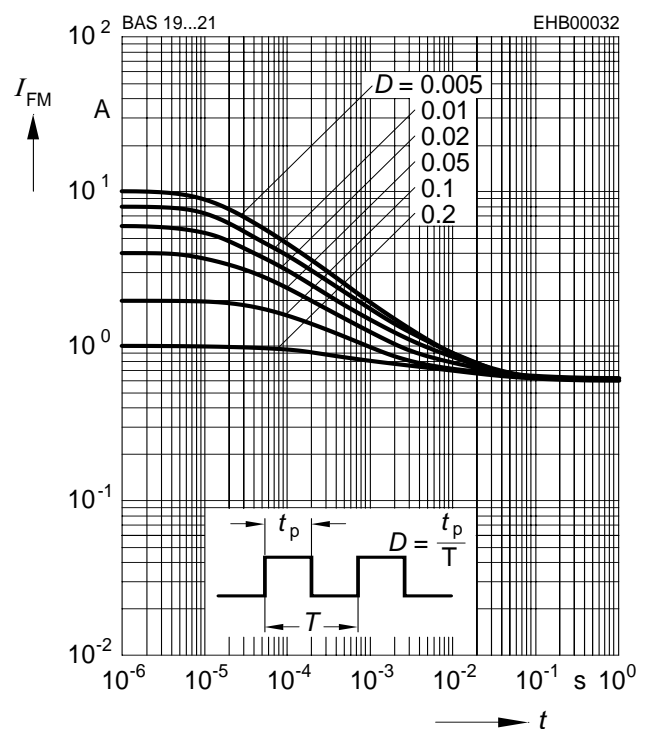

Reverse voltage  $V_R = f(T_A)$

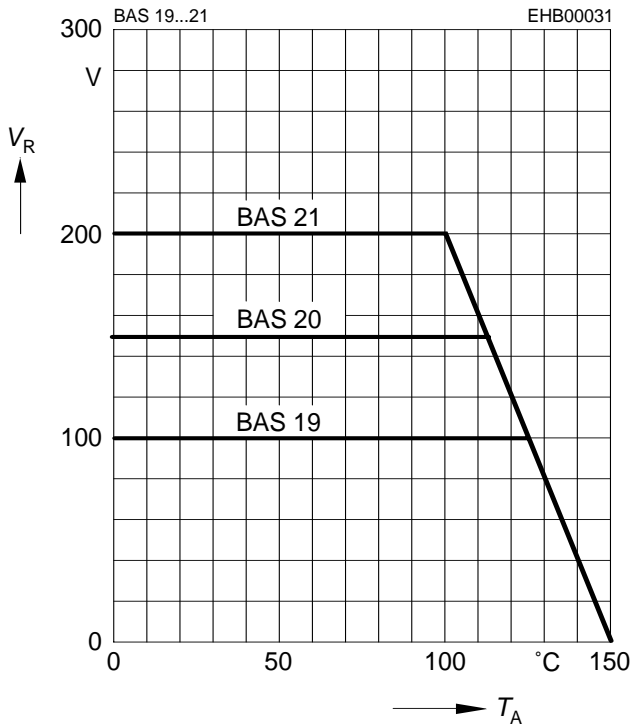

Permissible Pulse Load

$I_{Fmax} / I_{FDC} = f(t_p)$

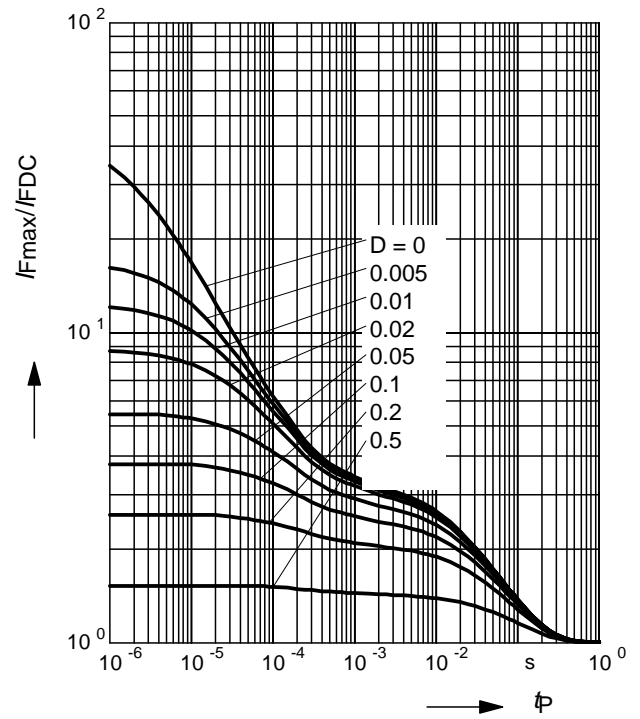

Permissible Puls Load  $R_{thJS} = f(t_p)$

