

IFX2931

Low Dropout Linear Voltage Regulator

IFX2931GV50
IFX2931GV33

Data Sheet

Rev. 1.13, 2011-02-10

Standard Power



1 Overview

Features

- Very Low Quiescent Current
- Output Current in Excess of 100mA
- Input-Output Differential Less than 0.6V for 5V-Version
- Reverse Battery Protection
- Output Current Limitation
- Overtemperature Shutdown
- Mirror-Image Insertion Protection
- Needs only small Output Capacitor $C_{OUT} = 10 \mu\text{F}$
- Green Product (RoHS compliant)



PG-DSO-8

For automotive and transportation applications, please refer to the Infineon TLE and TLF voltage regulator series.

General Description

The IFX2931 is a positive voltage regulator with a very low quiescent current of 1mA or less when supplying 10mA loads. The IFX2931GV50 also offers an extremely low dropout voltage required for proper regulation: 0.2V for output currents of 10mA. Therefore the IFX2931 is the ideal supply for standby power systems. It is suitable for e.g. memory standby circuits, CMOS and other low power processor power supplies. It certainly can also be used for any system demanding as much as 100mA of output current. The IFX2931 is protected from reverse polarity condition and can withstand input voltages of 28 V continuously. The IFX2931 cannot be harmed by temporary mirror-image insertion. Additional protection features such as output current limitation and overtemperature shutdown are also implemented. The IFX2931 comes in an 8-lead SMD package (PG-DSO-8).

Type	Package	Marking
IFX2931GV50	PG-DSO-8	IFX2931
IFX2931GV33	PG-DSO-8	2931V33

2 Block Diagram

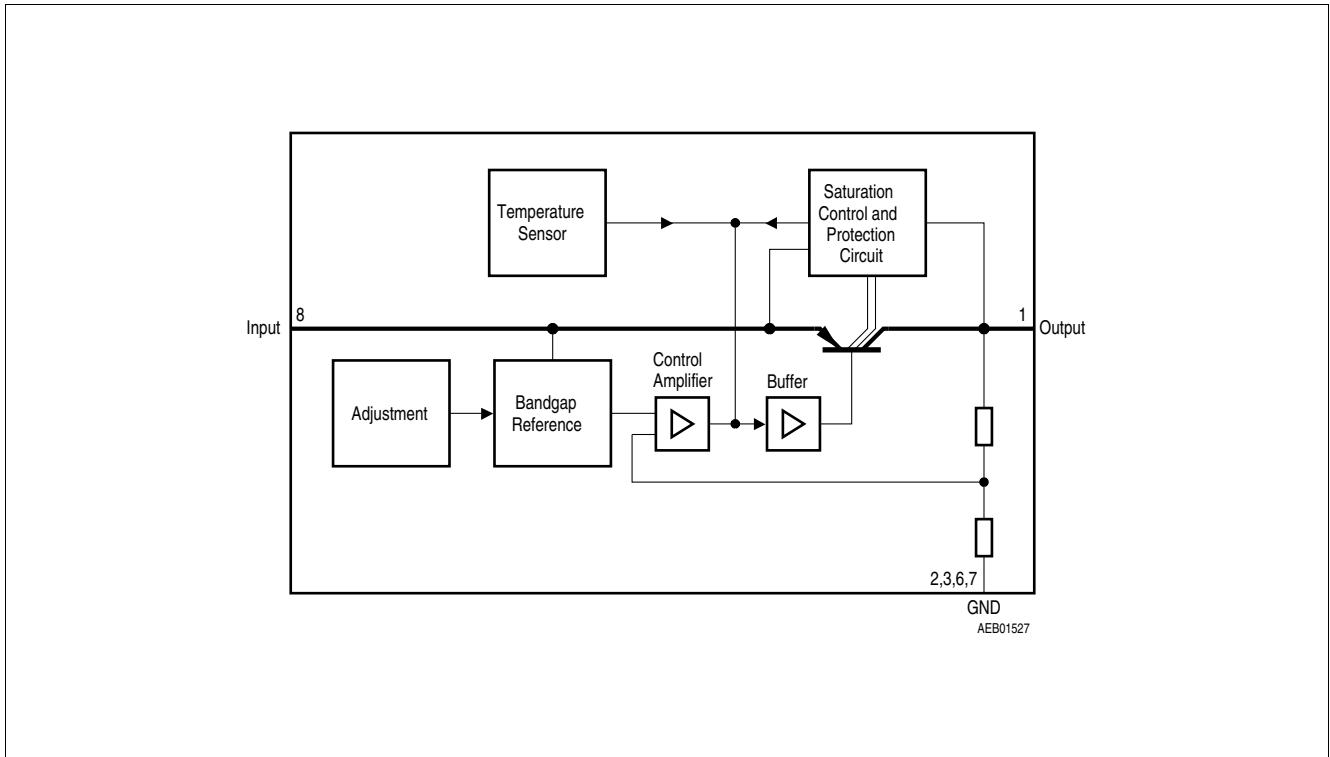

Figure 1 Block Diagram

3 Pin Configuration

3.1 Pin Assignment

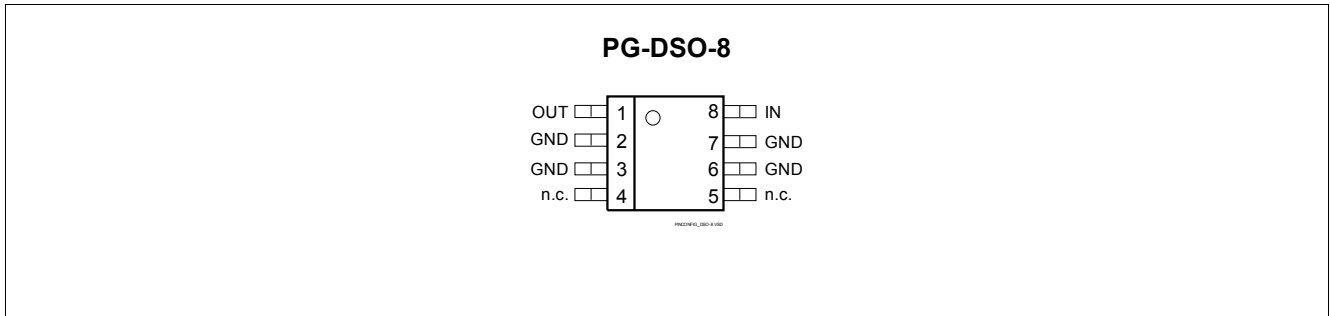

Figure 2 Pin Configuration

3.2 Pin Definitions and Functions IFX2931GV50, IFX2931GV33 (PG-DSO-8)

Pin	Symbol	Function
1	OUT	Output block to GND with a capacitor close to the IC terminals, respecting the values given for its capacitance C_{OUT} and ESR in “Typical Performance Characteristics” on Page 9
2,3,6,7	GND	Ground
4,5	n.c.	not connected
8	IN	Input for compensating line influences, a capacitor to GND close to the IC terminals is recommended

4 General Product Characteristics

4.1 Absolute Maximum Ratings

Absolute Maximum Ratings ¹⁾

$T_j = -40 \text{ °C}$ to 125 °C ; all voltages with respect to ground, positive current flowing into pin (unless otherwise specified)

Pos.	Parameter	Symbol	Limit Values		Unit	Conditions
			Min.	Max.		
Input						
4.1.1	Voltage	V_I	-30	28	V	–
Output						
4.1.2	Voltage	V_{OUT}	-0.3	28	V	–
Temperatures						
4.1.3	Junction Temperature	T_j	-40	125	°C	–
4.1.4	Storage Temperature	T_{stg}	-55	150	°C	–
ESD Susceptibility						
4.1.5	ESD Resistivity to GND	V_{ESD}	-2	2	kV	HBM ²⁾

1) Not subject to production test, specified by design.

2) ESD susceptibility, HBM according to EIA/JESD 22-A114B

Note: Stresses above the ones listed here may cause permanent damage to the device. Exposure to absolute maximum rating conditions for extended periods may affect device reliability.

Note: Integrated protection functions are designed to prevent IC destruction under fault conditions described in the data sheet. Fault conditions are considered as "outside" normal operating range. Protection functions are not designed for continuous repetitive operation.

4.2 Functional Range

Pos.	Parameter	Symbol	Limit Values		Unit	Conditions
			Min.	Max.		
4.2.1	Input Voltage	V_I	6	28	V	IFX2931GV50
4.2.2			4.4	26	V	IFX2931GV33
4.2.3	Junction Temperature	T_j	-40	125	°C	–

Note: Within the functional range the IC operates as described in the circuit description. The electrical characteristics are specified within the conditions given in the related electrical characteristics table.

4.3 Thermal Resistance

Pos.	Parameter	Symbol	Limit Values			Unit	Conditions
			Min.	Typ.	Max.		
IFX2931GV50, IFX2931GV33 (PG-DSO-8)							
4.3.1	Junction to Soldering Point ¹⁾	R_{thJSP}	–	39	–	K/W	measured to group of pins 2, 3, 6, 7
4.3.2	Junction to Ambient ¹⁾	R_{thJA}	–	96	–	K/W	Footprint only ²⁾
4.3.3			–	67	–	K/W	300mm ² heatsink area on PCB ²⁾
4.3.4			–	66	–	K/W	600mm ² heatsink area on PCB ²⁾

1) not subject to production test, specified by design

2) Specified R_{thJA} value is according to Jedec JESD51-2,-7 at natural convection on FR4 2s2p board; The Product (Chip+Package) was simulated on a 76.2 x 114.3 x 1.5 mm board with 2 inner copper layers (2 x 70µm Cu, 2 x 35µm Cu).

5 Electrical Characteristics

5.1 Electrical Characteristics IFX2931GV50

Electrical Characteristics

$V_I = 14\text{ V}$, $T_j = -40\text{ °C}$ to 125 °C , $I_{OUT} = 10\text{ mA}$, all voltages with respect to ground, positive current flowing into pin (unless otherwise specified)

Pos.	Parameter	Symbol	Limit Values			Unit	Conditions
			Min.	Typ.	Max.		
5.1.1	Output Voltage	V_{OUT}	4.75	5	5.25	V	$T_j = 25\text{ °C}$
			4.5	5	5.5	V	–
5.1.2	Line Regulation	$\Delta V_{OUT,line}$	–	2	10	mV	$9\text{ V} < V_I < 16\text{ V}$
5.1.3			–	4	30	mV	$6\text{ V} < V_I < 26\text{ V}$
5.1.4	Load Regulation	$\Delta V_{OUT,load}$	–	-14	-50	mV	$5\text{ mA} < I_{OUT} < 100\text{ mA}$
5.1.5	Output Impedance ¹⁾	Z_{OUT}	–	200	–	m Ω	$I_{OUT} = 100\text{ mA}_{DC}$ and $I_{OUT} = 10\text{ mA}_{rms}$ 100 Hz - 10 kHz
5.1.6	Current Consumption	I_q	–	0.4	1	mA	$I_{OUT} = 10\text{ mA}$ $6\text{ V} < V_I < 26\text{ V}$
5.1.7			–	9	15	mA	$I_{OUT} = 100\text{ mA}$
5.1.8	Output Noise Voltage ¹⁾	V_{noise}	–	500	–	μV_{rms}	100 Hz - 10 kHz $C_{OUT} = 100\text{ }\mu\text{F}$
5.1.9	Long Term Stability ¹⁾	$\Delta V_{OUT,1000h}$	–	20	–	mV /1000h	–
5.1.10	Ripple Rejection ¹⁾	$PSRR$	–	80	–	dB	$f_{ripple} = 120\text{ Hz}$
5.1.11	Dropout Voltage ²⁾	V_{DR}	–	0.05	0.2	V	$I_{OUT} = 10\text{ mA}$
5.1.12			$V_I - V_{OUT}$	–	0.3	0.6	V

1) not subject to production test, specified by design

2) obtained when the output voltage has dropped 100mV below the nominal value

5.2 Electrical Characteristics IFX2931GV33
Electrical Characteristics

$V_I = 14\text{ V}$, $T_j = -40\text{ °C}$ to 125 °C , $I_{OUT} = 10\text{ mA}$, all voltages with respect to ground, positive current flowing into pin (unless otherwise specified)

Pos.	Parameter	Symbol	Limit Values			Unit	Conditions
			Min.	Typ.	Max.		
5.2.1	Output Voltage	V_{OUT}	3.135	3.3	3.465	V	$T_j = 25\text{ °C}$
			2.97	3.3	3.63	V	$4.4\text{ V} < V_I < 26\text{ V}$ $I_{OUT} = 100\text{ mA}$
5.2.2	Line Regulation	$\Delta V_{OUT,line}$	–	4	33	mV	$4.4\text{ V} < V_I < 26\text{ V}$ $T_j = 25\text{ °C}$
5.2.3	Load Regulation	$\Delta V_{OUT,load}$	–	-10	-50	mV	$5\text{ mA} < I_{OUT} < 100\text{ mA}$ $T_j = 25\text{ °C}$
5.2.4	Output Impedance ¹⁾	Z_{OUT}	–	200	–	mΩ	$I_{OUT} = 100\text{ mA}_{DC}$ and $I_{OUT} = 10\text{ mA}_{rms}$ 100 Hz - 10 kHz
5.2.5	Current Consumption	I_q	–	0.4	1	mA	$I_{OUT} = 10\text{ mA}$ $4.4\text{ V} < V_I < 26\text{ V}$
5.2.6			–	15	–	mA	$I_{OUT} = 100\text{ mA}$
5.2.7	Output Noise Voltage ¹⁾	V_{noise}	–	330	–	μV_{rms}	10 Hz - 100 kHz $C_{OUT} = 100\text{ }\mu\text{F}$
5.2.8	Long Term Stability ¹⁾	$\Delta V_{OUT,1000h}$	–	13	–	mV /1000h	–
5.2.9	Ripple Rejection ¹⁾	$PSRR$	–	80	–	dB	$f_{ripple} = 120\text{ Hz}$
5.2.10	Dropout Voltage ²⁾ $V_I - V_{OUT}$	V_{DR}	–	0.85	1.1	V	$I_{OUT} = 100\text{ mA}$, $T_j = 25\text{ °C}$

1) not subject to production test, specified by design

2) obtained when the output voltage has dropped 100mV below the nominal value

5.3 Typical Performance Characteristics

Dropout Voltage V_{DR} versus Output Current I_{OUT}

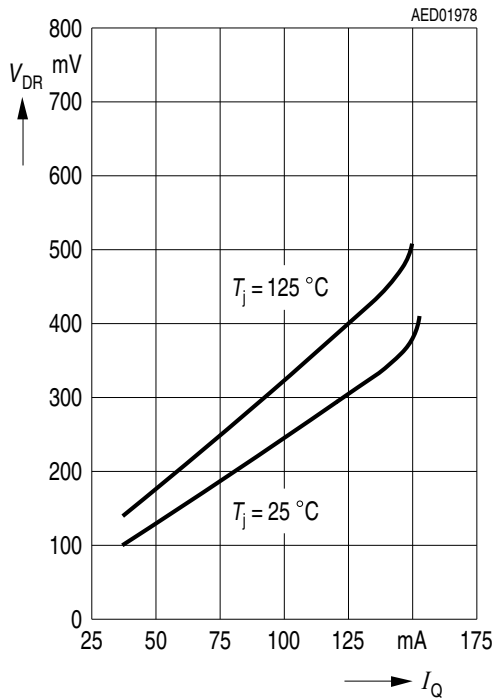

IFX2931GV50: Output Voltage V_{OUT} versus Input Voltage V_I

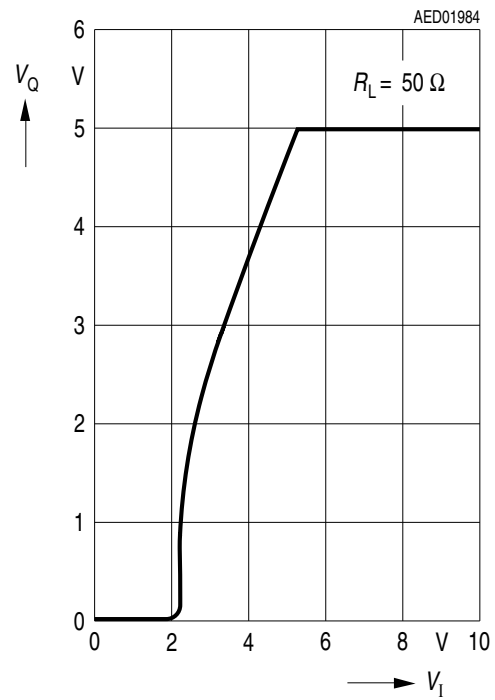

IFX2931GV33: Output Voltage V_{OUT} versus Input Voltage V_I

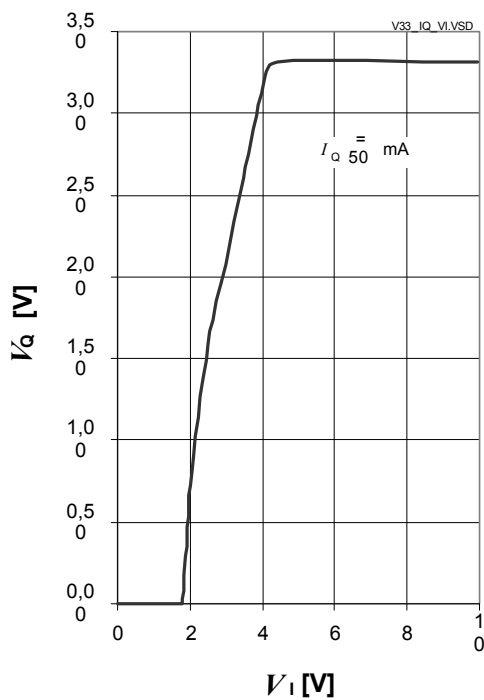

Load Transient Response

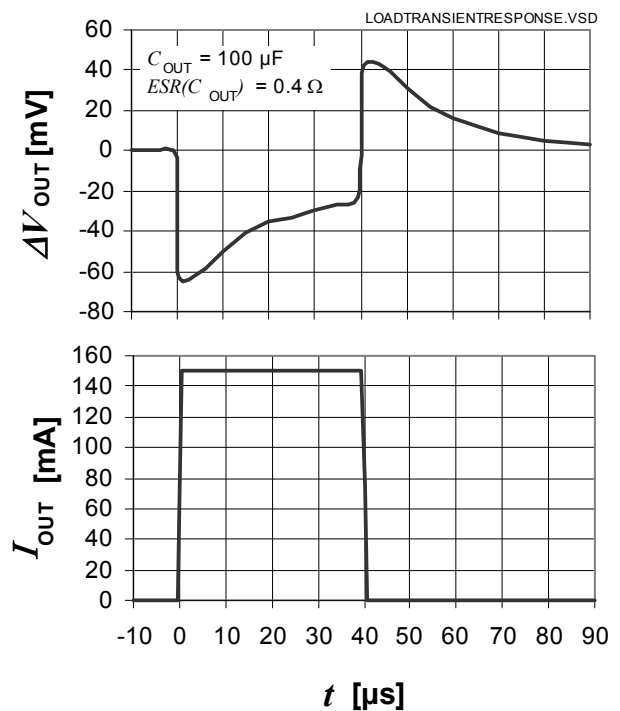

IFX2931GV50: Output Voltage V_{OUT} versus Junction Temperature T_j

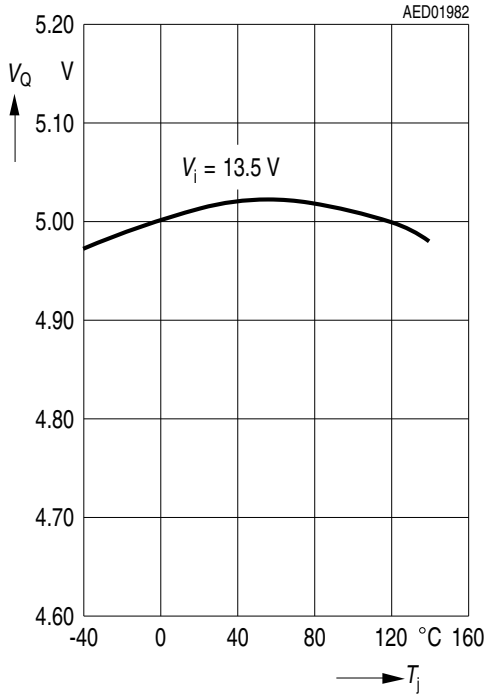

IFX2931GV33: Output Voltage V_{OUT} versus Junction Temperature T_j

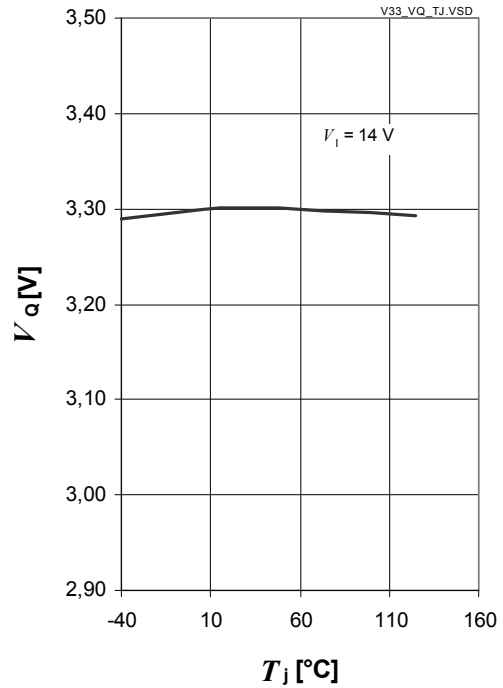

Output Current I_{OUT} versus Input Voltage V_i

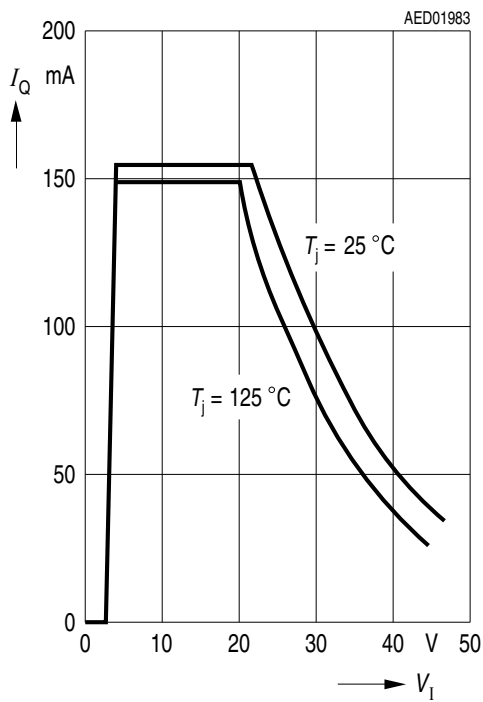

Current Consumption I_q versus Low Output Current I_{OUT}

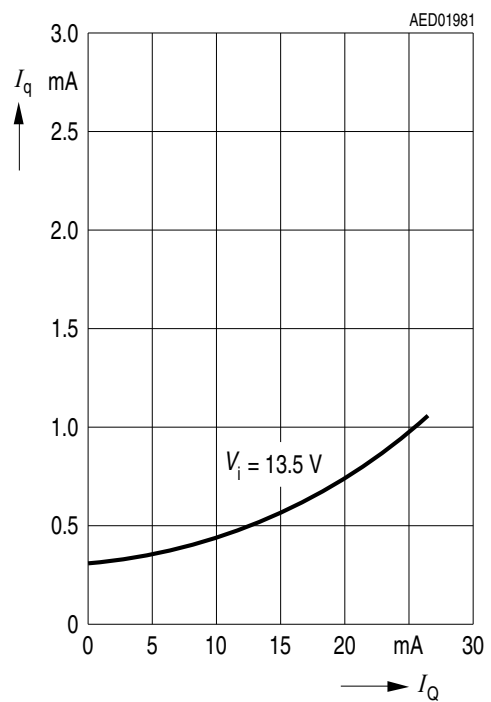

Current Consumption I_q versus Output Current I_{OUT}

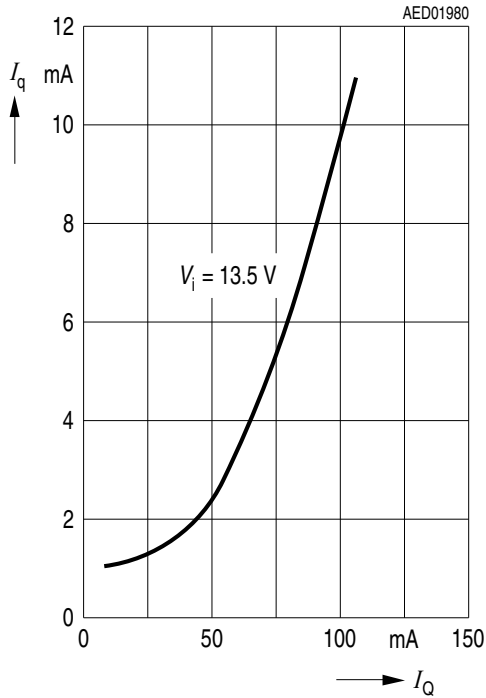

Current Consumption I_q versus Input Voltage V_i

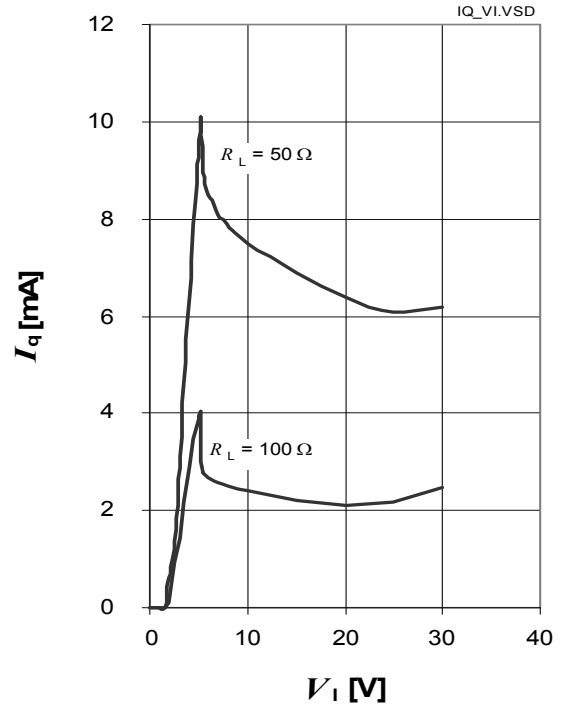

Power Supply Ripple Rejection $PSRR$ versus Frequency f

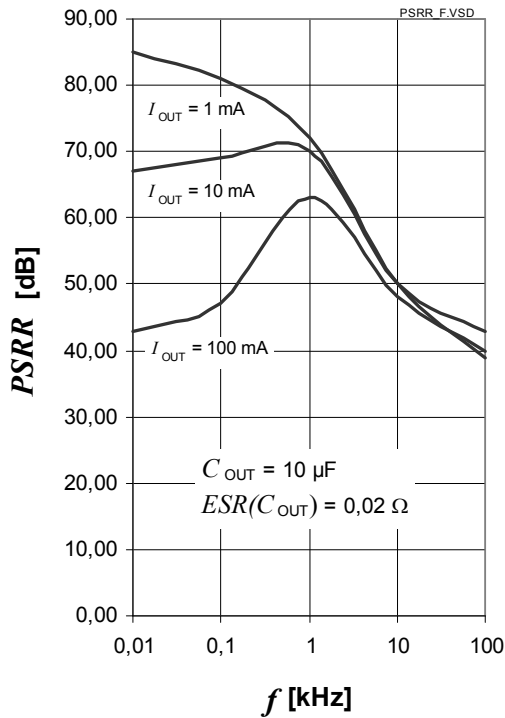

IFX2931GV50: Output Capacitor's Equivalent Series Resistance $ESR(C_{OUT})$ versus Output Current I_{OUT}

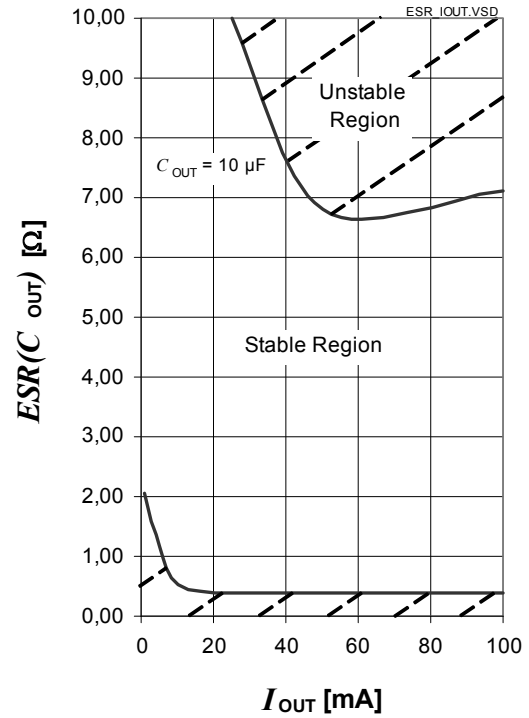

IFX2931GV33: Output Capacitor's Equivalent Series Resistance $ESR(C_{OUT})$ versus Output Current I_{OUT}

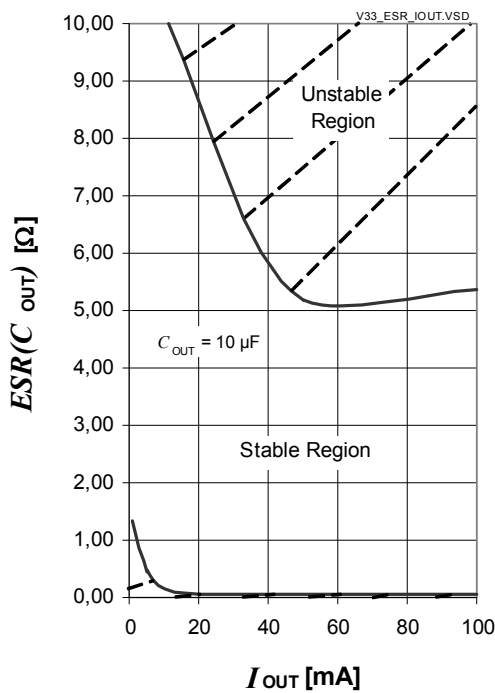

6 Package Outlines

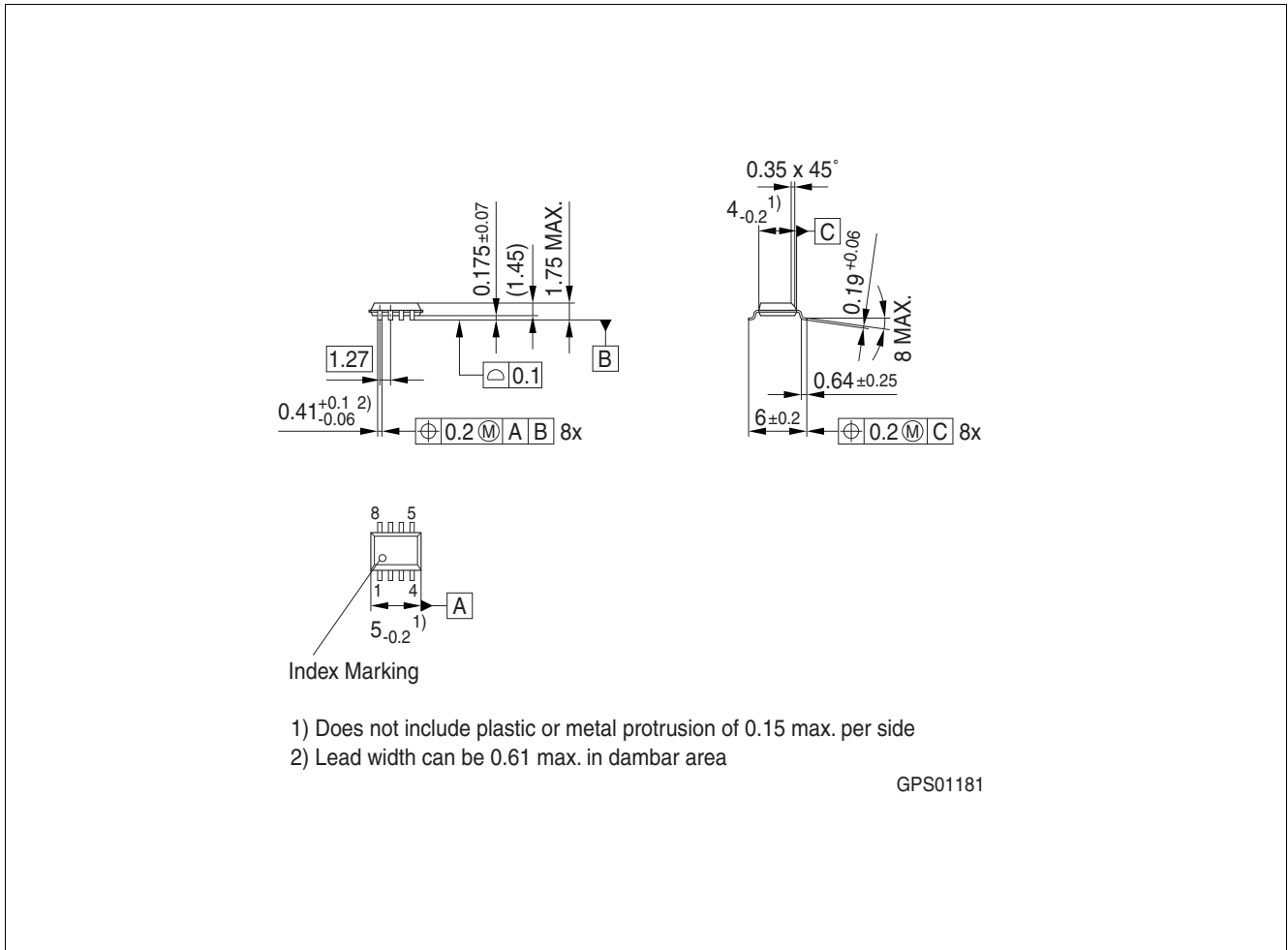

Figure 3 PG-DSO-8

Green Product (RoHS compliant)

To meet the world-wide customer requirements for environmentally friendly products and to be compliant with government regulations the device is available as a green product. Green products are RoHS-Compliant (i.e. Pb-free finish on leads and suitable for Pb-free soldering according to IPC/JEDEC J-STD-020).

For further information on alternative packages, please visit our website:

<http://www.infineon.com/packages>.

Dimensions in mm

7 Revision History

Revision	Date	Changes
1.13	2011-02-10	Editorial change on page 9 (Typo)
1.12	2010-02-23	Editorial change
1.11	2009-10-19	Coverpage changed Overview page: Inserted reference statement to TLE/TLF series.
1.1	2009-05-04	Version with 3.3V output voltage and all related description added
		Form Page 2 on on top right "IFX2931GV50" updated to "IFX2931"
		In " Features " on Page 2 "Input-Output Differential Less than 0.6V" updated to "Input-Output Differential Less than 0.6V for 5V-Version"
		In " General Description " on Page 2 , all "IFX2931GV50" replaced by "IFX2931"; in line 2, "It" replaced by "The IFX2931GV50";
		In " Pin Configuration " on Page 4 ", IFX2931GV33" added
		In " Functional Range " on Page 5 Item 4.2.2 added, in Item 4.2.1 's Condition "IFX2931GV50" added
		In Table 4.3 "Thermal Resistance" on Page 6 ", IFX2931GV33" added
		"Electrical Characteristics IFX2931GV50" on Page 7 updated: "IFX2931GV50" added in this heading
		Table 5.2 "Electrical Characteristics IFX2931GV33" on Page 8 added
		In " Typical Performance Characteristics " on Page 9 performance characteristics " IFX2931GV33: Output Voltage V_{OUT} versus Input Voltage V_I " on Page 9 , " IFX2931GV33: Output Voltage V_{OUT} versus Junction Temperature T_j " on Page 10 and " IFX2931GV33: Output Capacitor's Equivalent Series Resistance $ESR(C_{OUT})$ versus Output Current I_{OUT} " on Page 12 added; "IFX2931GV50" added in description of performance characteristics " IFX2931GV50: Output Voltage V_{OUT} versus Input Voltage V_I " on Page 9 , " IFX2931GV50: Output Voltage V_{OUT} versus Junction Temperature T_j " on Page 10 and " IFX2931GV50: Output Capacitor's Equivalent Series Resistance $ESR(C_{OUT})$ versus Output Current I_{OUT} " on Page 12
1.0	2008-04-21	final version data sheet

Edition 2011-02-10

**Published by
Infineon Technologies AG
81726 Munich, Germany**

**© 2011 Infineon Technologies AG
All Rights Reserved.**

Legal Disclaimer

The information given in this document shall in no event be regarded as a guarantee of conditions or characteristics. With respect to any examples or hints given herein, any typical values stated herein and/or any information regarding the application of the device, Infineon Technologies hereby disclaims any and all warranties and liabilities of any kind, including without limitation, warranties of non-infringement of intellectual property rights of any third party.

Information

For further information on technology, delivery terms and conditions and prices, please contact the nearest Infineon Technologies Office (www.infineon.com).

Warnings

Due to technical requirements, components may contain dangerous substances. For information on the types in question, please contact the nearest Infineon Technologies Office.

Infineon Technologies components may be used in life-support devices or systems only with the express written approval of Infineon Technologies, if a failure of such components can reasonably be expected to cause the failure of that life-support device or system or to affect the safety or effectiveness of that device or system. Life support devices or systems are intended to be implanted in the human body or to support and/or maintain and sustain and/or protect human life. If they fail, it is reasonable to assume that the health of the user or other persons may be endangered.