

HiRel RadHard Power-MOS

- Low $R_{DS(on)}$
- Single Event Effect (SEE) hardened
 LET 85, Range: 118 μ m LET 55, Range: 90 μ m
 $V_{GS} = -10V, V_{DS} = 250V$ $V_{GS} = -15V, V_{DS} = 250V$
 $V_{GS} = -15V, V_{DS} = 120V$ $V_{GS} = -20V, V_{DS} = 160V$
- Total Ionisation Dose (TID) hardened
 100 kRad (Level R)
- Hermetically sealed
- N-channel
-  **ESA Space Qualified**
 ESCC Detail Spec. No.: 5205/026

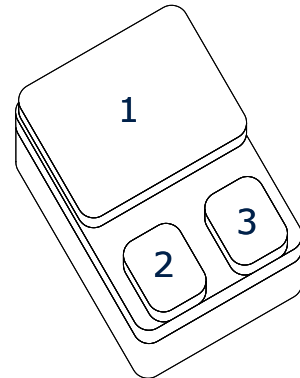

Type	Marking	Pin Configuration				Package
		1	2	3	-	
BUY25CS12J-01	-	D	G	S	-	SMD05

Maximum Ratings

Parameter	Symbol	Values	Unit
Drain Source Voltage	V_{DS}	250	V
Gate Source Voltage	V_{GS}	+/- 20	V
Drain Gate Voltage	V_{DG}	250	V
Continuous Drain Current $T_C = 25\text{ }^\circ\text{C}$ $T_C = 100\text{ }^\circ\text{C}$	I_D	12.4 8	A
Continuous Source Current	I_S	12.4	A
Drain Current Pulsed, t_p limited by T_{jmax}	I_{DM}	50	Apk
Total Power Dissipation ¹⁾	P_{tot}	75	W
Operating and Storage Temperature	T_{op}	-55 to + 150	$^\circ\text{C}$
Avalanche Energy	E_{AS}	60	mJ

Thermal Characteristics

Thermal Resistance (Junction to Case)	R_{thJC}	1.66	K/W
Soldering Temperature	T_{sol}	250	$^\circ\text{C}$

Notes.:

1) For $T_S \leq 25^\circ\text{C}$. For $T_S > 25^\circ\text{C}$ derating is required.

Electrical Characteristics, at $T_A=25^\circ\text{C}$; unless otherwise specified

Parameter	Symbol	Values			Unit
		min.	typ.	max.	
DC Characteristics					
Breakdown Voltage Drain to Source $I_D = 0.25\text{mA}$, $V_{GS} = 0\text{V}$	B_{VDSS}	250	-	-	V
Gate Threshold Voltage $I_D = 1.0\text{mA}$, $V_{DS} \geq V_{GS}$	$V_{GS(th)}$	2.0	-	4.0	V
Gate to Source Leakage Current $V_{DS} = 0\text{V}$, $V_{GS} = +/- 20\text{V}$	I_{GSS}	-	-	+/-100	nA
Drain Current $V_{DS} = 200\text{V}$, $V_{GS} = 0\text{V}$	I_{DSS}	-	-	25	μA
Drain Source On Resistance ¹⁾ $V_{GS} = 10\text{V}$, $I_D = 8\text{A}$	$r_{DS(ON)}$	-	-	0.13	Ω
Source Drain Diode, Forward Voltage ^{1), 2)} $V_{GS} = 0\text{V}$, $I_S = 12.4\text{A}$	V_{SD}	-	-	1.2	V
AC Characteristics					
Turn-on Delay Time $V_{DD} = 50\% V_{DS}$, $I_D = 8\text{A}$, $R_G = 4.7\Omega$	$t_{d(ON)}$	-	14	25	ns
Rise Time $V_{DD} = 50\% V_{DS}$, $I_D = 8\text{A}$, $R_G = 4.7\Omega$	t_r	-	7	25	ns
Turn-off Delay Time $V_{DD} = 50\% V_{DS}$, $I_D = 8\text{A}$, $R_G = 4.7\Omega$	$t_{d(OFF)}$	-	25	35	ns
Fall Time $V_{DD} = 50\% V_{DS}$, $I_D = 8\text{A}$, $R_G = 4.7\Omega$	t_f	-	5	20	ns
Reverse Recovery Time $V_{DD} < 50\% V_{DS}$, $I_D = 12.4\text{A}$	t_{rr}	-	300	400	ns
Common Source Input Capacitance $V_{DS} = 100\text{V}$, $V_{GS} = 0\text{V}$, $f = 1.0\text{MHz}$	C_{iss}	1300	-	1900	pF
Common Source Output Capacitance $V_{DS} = 100\text{V}$, $V_{GS} = 0\text{V}$, $f = 1.0\text{MHz}$	C_{oss}	90	-	150	pF
Common Source Reverse Transfer Capacitance $V_{DS} = 100\text{V}$, $V_{GS} = 0\text{V}$, $f = 1.0\text{MHz}$	C_{rss}	1	-	6	pF
Total Gate Charge $V_{DD} = 50\% V_{DS}$, $V_{GS} = 10\text{V}$, $I_D = 12.4\text{A}$	Q_G	-	25	42	nC

Notes.:

 1) Pulsed Measurement: Pulse Width < 300 μs , Duty Cycle <2.0%.

2) Measured within 2.0 mm of case.

Electrical Characteristics

 at $T_A=125^\circ\text{C}$; unless otherwise specified

Parameter	Symbol	Values		Unit
		min.	max.	
DC Characteristics				
Gate Threshold Voltage $I_D = 1.0\text{mA}, V_{DS} \geq V_{GS}$	$V_{GS(th)}$	1.5	-	V
Gate to Source Leakage Current $V_{DS} = 0\text{V}, V_{GS} = +/- 20\text{V}$	I_{GSS}	-	+/-200	nA
Drain Current $V_{DS} = 200\text{V}, V_{GS} = 0\text{V}$	I_{DSS}	-	250	μA
Drain Source On Resistance ¹⁾ $V_{GS} = 10\text{V}, I_D = 8\text{A}$	$r_{DS(ON)}$	-	0.3	Ω

Notes.:

 1) Pulsed Measurement: Pulse Width < 300 μs , Duty Cycle <2.0%.

Electrical Characteristics

 at $T_A=-55^\circ\text{C}$; unless otherwise specified

Parameter	Symbol	Values		Unit
		min.	max.	
DC Characteristics				
Gate Threshold Voltage $I_D = 1.0\text{mA}, V_{DS} \geq V_{GS}$	$V_{GS(th)}$	-	5.0	V

1 Safe operating area

$I_D = f(V_{DS}); T_C = 25^\circ\text{C}$
 parameter: t_p

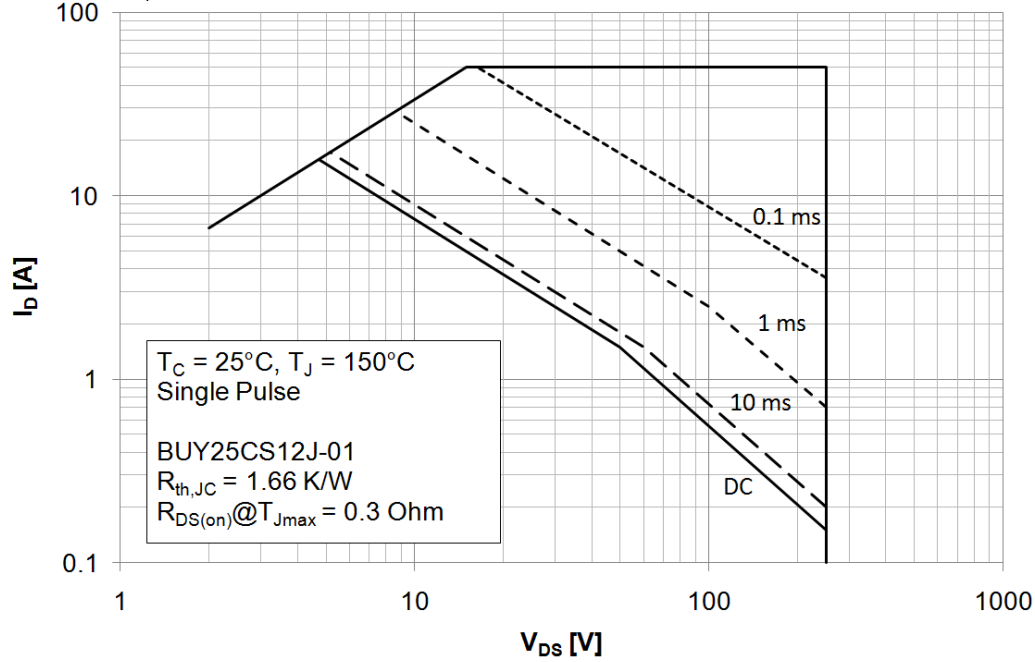

2 Max. transient thermal impedance

$Z_{thJC} = f(t_p)$
 parameter: $D = t_p/T$

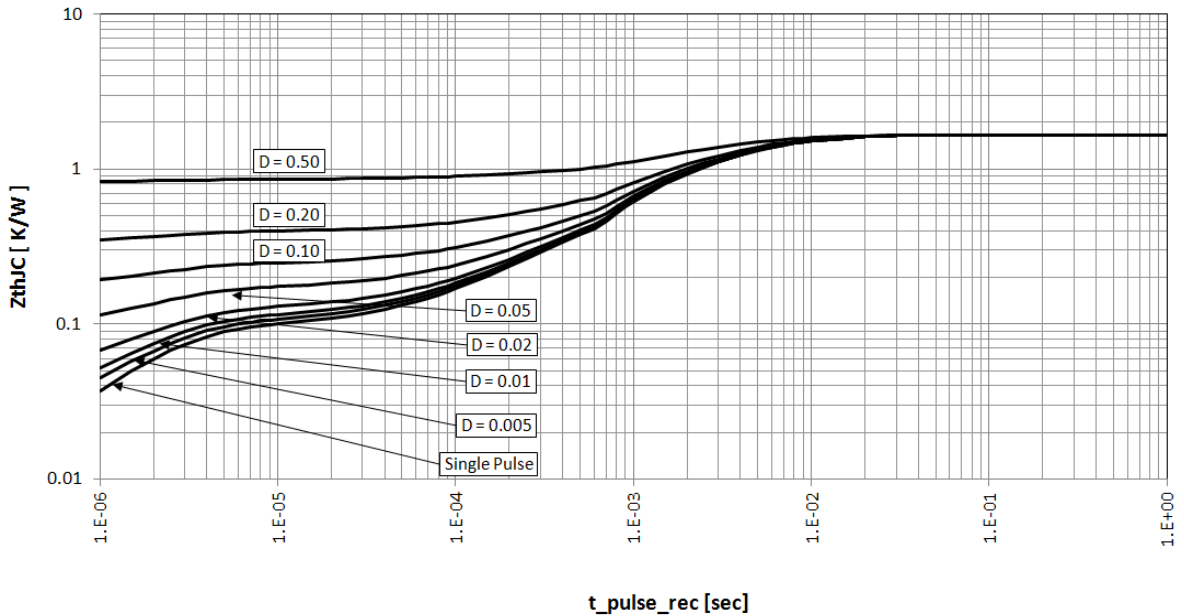

3 Typ. output characteristics

$I_D = f(V_{DS}); T_j = 25\text{ }^\circ\text{C}$
parameter: V_{GS}

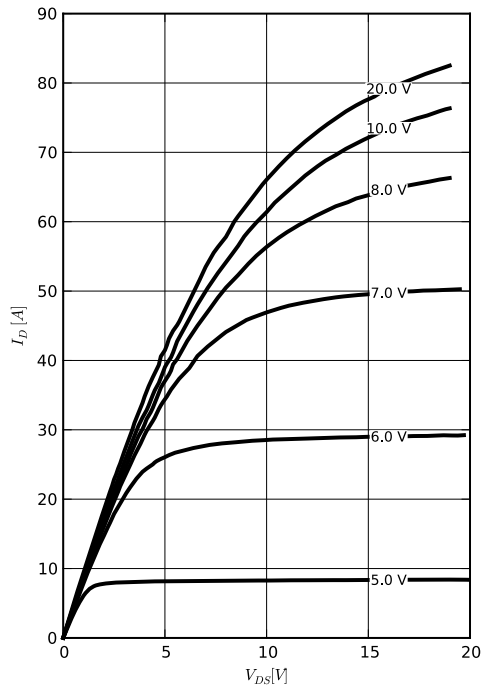

4 Typ. output characteristics

$I_D = f(V_{DS}); T_j = 150\text{ }^\circ\text{C}$
parameter: V_G

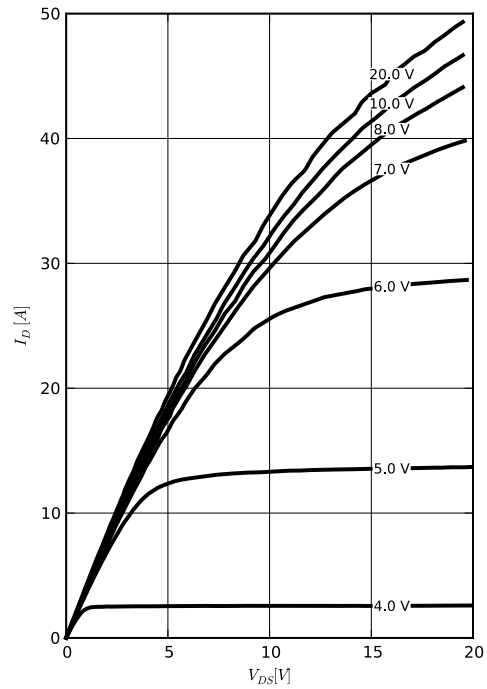

5 Typ. drain-source on-state resistance

$R_{DS(on)} = f(I_D); T_j = 150\text{ }^\circ\text{C}$
parameter: V_{GS}

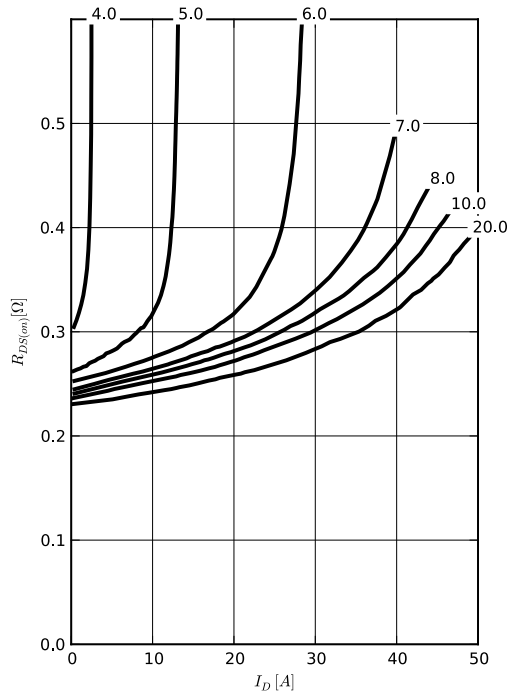

6 Typ. drain-source on-state resistance

$R_{DS(on)} = f(T_j)$
 $I_D = 8\text{ A}$

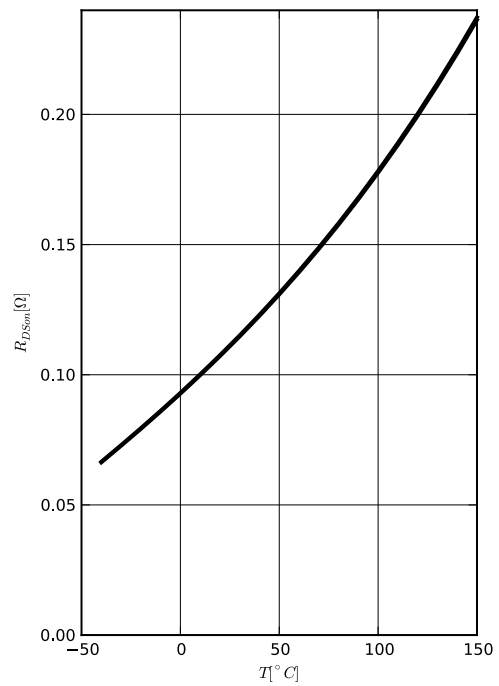

7 Typ. transfer characteristics

$I_D = f(V_{GS}); |V_{DS}| > 2 |I_D| R_{DS(on)max}$
parameter: T_j

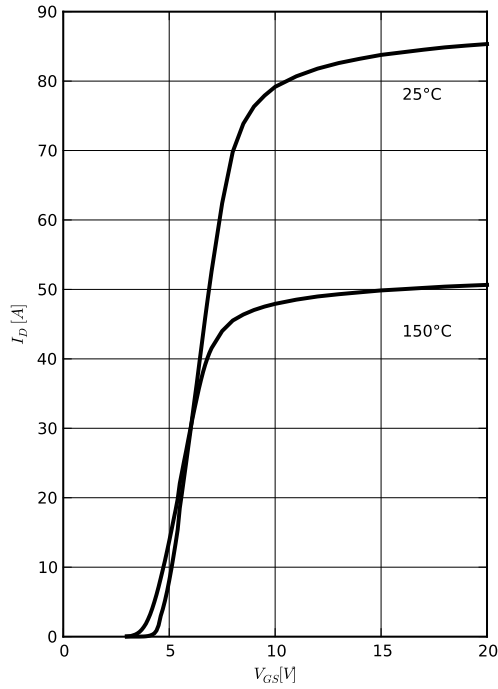

8 Typ. gate threshold voltage

$I_D = f(T_j)$
 $I_D = 1\text{mA}$



9 Typ. forward characteristics of reverse diode

$I_F = f(V_{SD})$
parameter: T_j

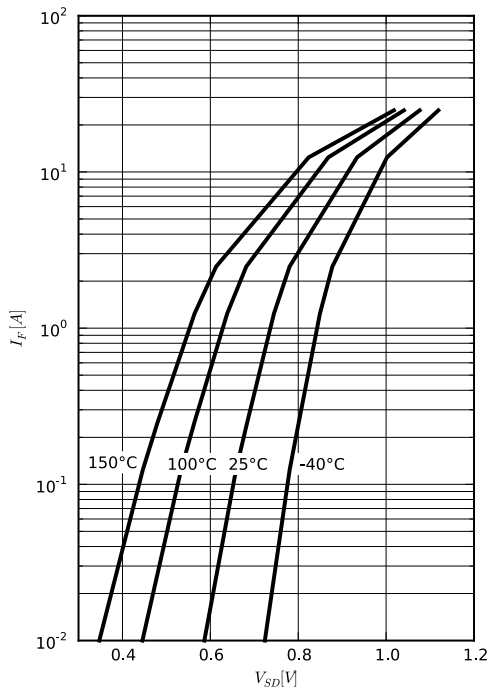

10 Typ. drain-source breakdown voltage

$BV_{DSS} = f(T_j)$
 $I_D = 250\mu\text{A}$

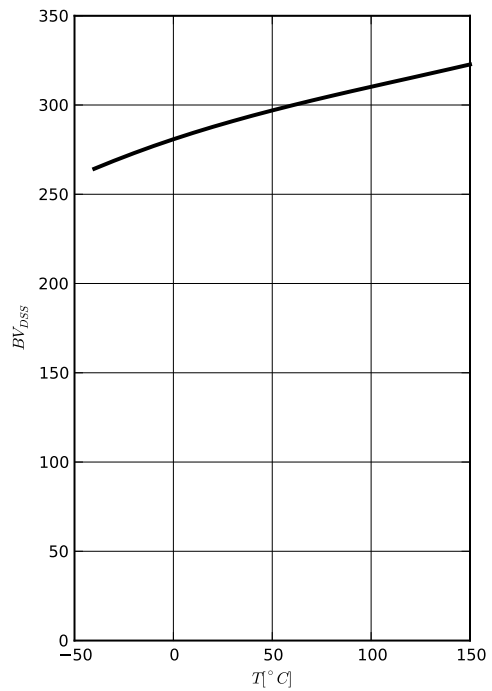

11 Typ. capacitances

$C = f(V_{DS}); V_{GS} = 0 \text{ V}; f = 1 \text{ MHz}$

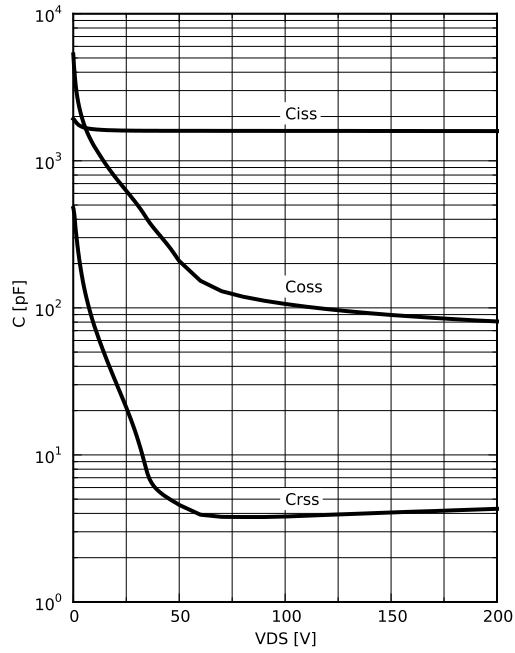

12 Typ. gate charge

$V_{GS} = f(Q_{gate}); I_D = 12.4 \text{ A pulsed}$
parameter: V_{DD}

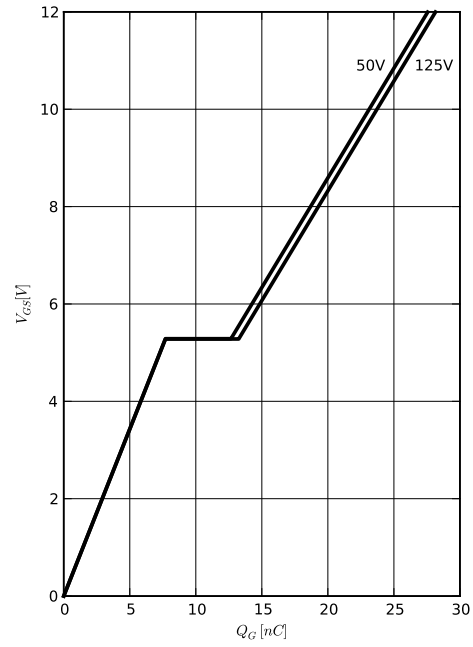

SMD05 Package

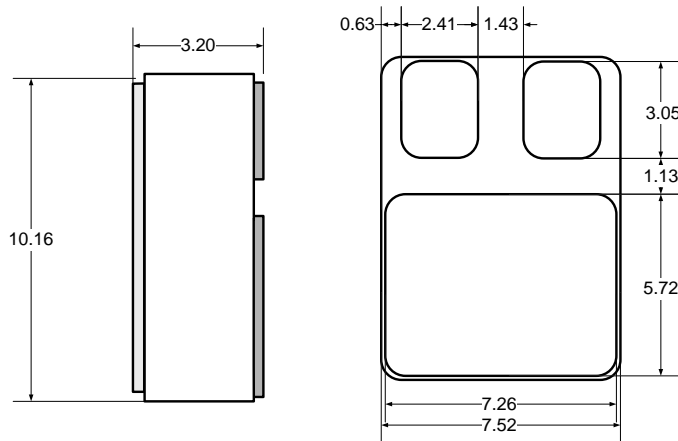

Edition 2016-09
 Published by
 Infineon Technologies AG
 85579 Neubiberg, Germany
 © Infineon Technologies AG 2016
 All Rights Reserved.

Dimensions are typical [mm]

Attention please!

The information given in this document shall in no event be regarded as a guarantee of conditions or characteristics (“Beschaffenheitsgarantie“). With respect to any examples or hints given herein, any typical values stated herein and/or any information regarding the application of the device, Infineon Technologies hereby disclaims any and all warranties and liabilities of any kind, including without limitation warranties of non-infringement of intellectual property rights of a third party.

Information

For further information on technology, delivery terms and conditions and prices please contact your nearest Infineon Technologies Office (www.infineon.com).

Warnings

Due to technical requirements components may contain dangerous substances. For information on the types in question please contact your nearest Infineon Technologies Office.

Infineon Technologies Components may only be used in life-support devices or systems with the expressed written approval of Infineon Technologies, if a failure of such components can reasonably be expected to cause the failure of that life-support device or system, or to affect the safety or effectiveness of that device or system.

Life support devices or systems are intended to be implanted in the human body, or to support and/or maintain and sustain and/or protect human life. If they fail, it is reasonable to assume that the health of the user or other persons may be endangered.