

**RAD-HARD
 SYNCHRONOUS RECTIFIER
 SURFACE MOUNT (SMD-2)**

**IRHSNA57064
 60V, N-CHANNEL**

Product Summary

Part Number	Radiation Level	R _{DS(on)}	Q _G
IRHSNA57064	100K Rads (Si)	6.5mΩ	160nC
IRHSNA53064	300K Rads (Si)	6.5mΩ	160nC
IRHSNA54064	600K Rads (Si)	6.5mΩ	160nC
IRHSNA58064	1000K Rads (Si)	6.5mΩ	160nC

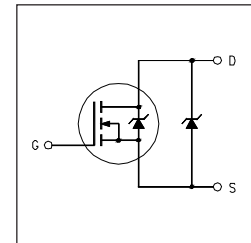
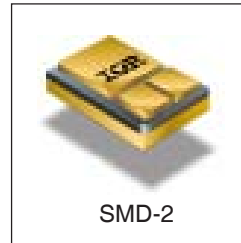

Description:

The SynchFet family of Co-Pack RAD-Hard MOSFETs and Schottky diodes offers the designer an innovative, board space saving solution for switching regulator and power management applications. RAD-Hard MOSFETs utilize advanced processing techniques to achieve extremely low on-resistance per silicon area. Combining this technology with International Rectifier's low forward drop Schottky rectifiers results in an extremely efficient device suitable for use in a wide variety of Military and Space applications.

Features:

- Co-Pack N-channel RAD-Hard MOSFET and Schottky Diode
- Ideal for Synchronous Rectifiers in DC-DC Converters up to 56A Output
- Low Conduction Losses
- Low Switching Losses
- Low Vf Schottky Rectifier
- Refer to IRHSLNA57064 for Lower Inductance

Absolute Maximum Ratings

Pre-Irradiation

	Parameter		Units
ID @ VGS = 12V, TC = 25°C	Continuous Drain or Source Current	56*	A
ID @ VGS = 12V, TC = 100°C	Continuous Drain or Source Current	56*	
IDM	Pulsed Drain Current ①	224	
PD @ TC = 25°C	Max. Power Dissipation	250	W
	Linear Derating Factor	2.0	W/°C
VGS	Gate-to-Source Voltage	±20	V
EAS	Single Pulse Avalanche Energy ②	309	mJ
IAR	Avalanche Current ①	56	A
EAR	Repetitive Avalanche Energy ①	25	mJ
IF (AV) @ TC = 25°C	Schottky and Body Diode Avg. Forward Current ③	56*	A
IF (AV) @ TC = 100°C	Schottky and Body Diode Avg. Forward Current ③	56*	
TJ, TSTG	Operating and Storage Temperature Range	-55 to 125	°C
	Pckg. Mounting Surface Temp.	300 (for 5s)	
	Weight	3.3 (Typical)	

* Current is limited by package
 For footnotes refer to the last page

Electrical Characteristics @ T_j = 25°C (Unless Otherwise Specified)

	Parameter	Min	Typ	Max	Units	Test Conditions
B _V D _{SS}	Drain-to-Source Breakdown Voltage	60	—	—	V	V _{GS} = 0V, I _D = 1.0mA
R _D S(on)	Static Drain-to-Source On-State Resistance	—	—	6.5	mΩ	V _{GS} = 12V, I _D = 45A@
V _{GS} (th)	Gate Threshold Voltage	2.0	—	4.0	V	V _{DS} = V _{GS} , I _D = 1.0mA
g _{fs}	Forward Transconductance	45	—	—	S	V _{DS} = 15V, I _{DS} = 45A@
I _D SS	Zero Gate Voltage Drain Current	—	—	90	μA	V _{DS} = 48V, V _{GS} = 0V
		—	—	50	mA	V _{DS} = 48V, V _{GS} = 0V, T _J = 125°C
I _G SS	Gate-to-Source Leakage Forward	—	—	100	nA	V _{GS} = 20V
I _G SS	Gate-to-Source Leakage Reverse	—	—	-100	nA	V _{GS} = -20V
Q _g	Total Gate Charge	—	—	160	nC	V _{GS} = 12V, I _D = 45A, V _{DS} = 30V
Q _{gs}	Gate-to-Source Charge	—	—	55	nC	
Q _{gd}	Gate-to-Drain ('Miller') Charge	—	—	65	nC	
t _d (on)	Turn-On Delay Time	—	—	35	ns	V _{DD} = 30V, I _D = 45A, V _{GS} = 12V, R _G = 2.35Ω
t _r	Rise Time	—	—	125	ns	
t _d (off)	Turn-Off Delay Time	—	—	75	ns	
t _f	Fall Time	—	—	50	ns	
L _S + L _D	Total Inductance	—	7.03	—	nH	Measured from center of drain pad to center of source pad

Schottky Diode & Body Diode Ratings and Characteristics

	Parameter	Min	Typ	Max	Units	Test Conditions
V _S D	Diode Forward Voltage	—	—	0.93	V	T _J = -55°C, I _D = 45A, V _{GS} = 0V@
		—	—	0.90		T _J = 25°C, I _D = 45A, V _{GS} = 0V@
		—	—	0.82		T _J = 125°C, I _D = 45A, V _{GS} = 0V@
t _{rr}	Reverse Recovery Time	—	—	100	ns	T _J = 25°C, I _F = 45A, di/dt ≤ 100A/μs
Q _{RR}	Reverse Recovery Charge	—	—	210	nC	V _{DS} ≤ 30V
L _S + L _D	Total Inductance	—	8.09	—	nH	Measured from center of drain pad to center of source pad (for Schottky only)
t _{on}	Forward Turn-On Time	Intrinsic turn-on time is negligible. Turn-on speed is substantially controlled by L _S + L _D				

Thermal Resistance

	Parameter	Min	Typ	Max	Units	Test Conditions
R _{th} JC	Junction-to-Case (MOSFET)	—	—	0.5	°C/W	
R _{th} JC	Junction-to-Case (Schottky)	—	—	0.7		

Note: Corresponding Spice and Saber models are available on International Rectifier Website.

For footnotes refer to the last page

Radiation Characteristics

IRHSNA57064

International Rectifier Radiation Hardened MOSFETs are tested to verify their radiation hardness capability. The hardness assurance program at International Rectifier is comprised of two radiation environments. Every manufacturing lot is tested for total ionizing dose (per notes 5 and 6) using the TO-3 package. Both pre- and post-irradiation performance are tested and specified using the same drive circuitry and test conditions in order to provide a direct comparison.

Table 1. Electrical Characteristics @ Tj = 25°C, Post Total Dose Irradiation ③④⑤

	Parameter	Up to 600K Rads(Si) ¹		1000K Rads (Si) ²		Units	Test Conditions
		Min	Max	Min	Max		
BV _{DSS}	Drain-to-Source Breakdown Voltage	60	—	60	—	V	V _{GS} = 0V, I _D = 1.0mA
V _{GS(th)}	Gate Threshold Voltage	2.0	4.0	1.5	4.0		V _{GS} = V _{DS} , I _D = 1.0mA
I _{GS}	Gate-to-Source Leakage Forward	—	100	—	100	nA	V _{GS} = 20V
I _{GS}	Gate-to-Source Leakage Reverse	—	-100	—	-100		V _{GS} = -20 V
I _{DSS}	Zero Gate Voltage Drain Current	—	10	—	25	μA	V _{DS} = 48V, V _{GS} = 0V
R _{DS(on)}	Static Drain-to-Source On-State Resistance (TO-3)	—	6.1	—	7.1	mΩ	V _{GS} = 12V, I _D = 45A
V _{SD}	Diode Forward Voltage	—	1.3	—	1.3	V	V _{GS} = 0V, I _S = 45A

1. Part numbers IRHSNA57064, IRHSNA53064 and IRHSNA54064
2. Part number IRHSNA58064

International Rectifier Radiation Hardened MOSFETs have been characterized in heavy ion environment for Single Event Effects (SEE). Single Event Effects characterization is illustrated in Fig. a and Table 2.

Table 2. Typical Single Event Effect Safe Operating Area ⑥

Ion	LET (MeV/(mg/cm ²))	Energy (MeV)	Range (μm)	V _{DS} (V)				
				@V _{GS} =0V	@V _{GS} =-5V	@V _{GS} =-10V	@V _{GS} =-15V	@V _{GS} =-20V
Kr	39.2	300	37.4	60	60	60	52	34
Xe	63.3	300	29.2	46	46	35	25	15
Au	86.6	2068	106	35	35	27	20	14

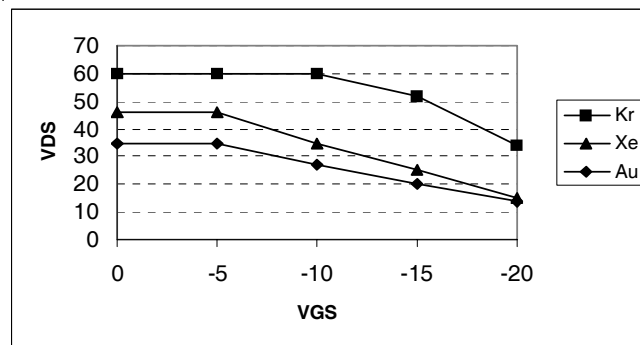

Fig a. Typical Single Event Effect, Safe Operating Area

For footnotes refer to the last page

www.irf.com

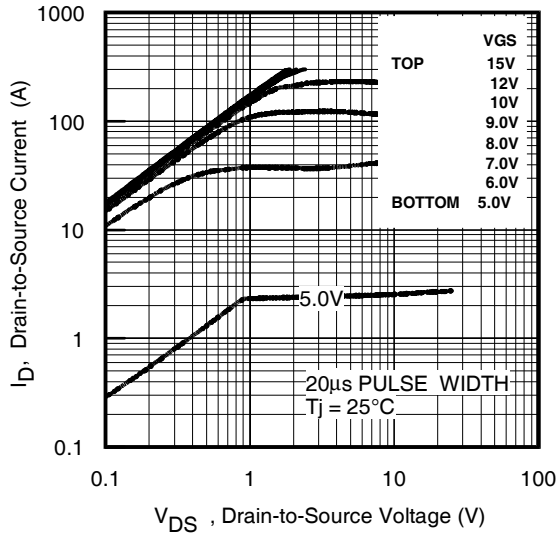

Fig 1. Typical Output Characteristics

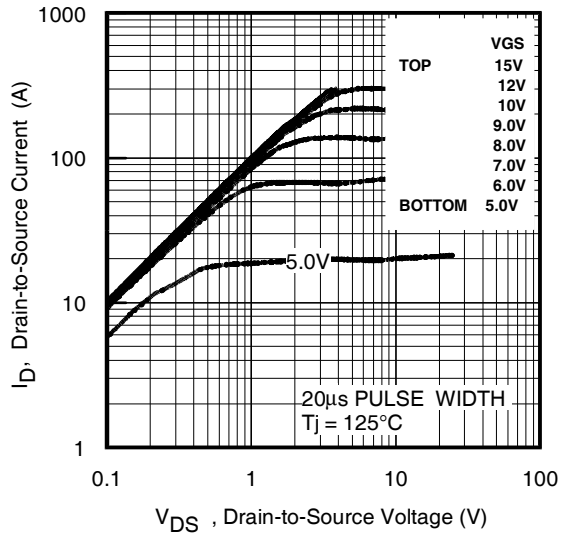

Fig 2. Typical Output Characteristics

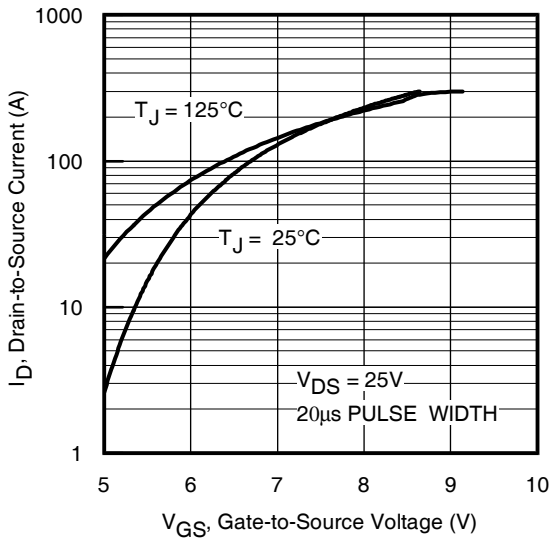

Fig 3. Typical Transfer Characteristics

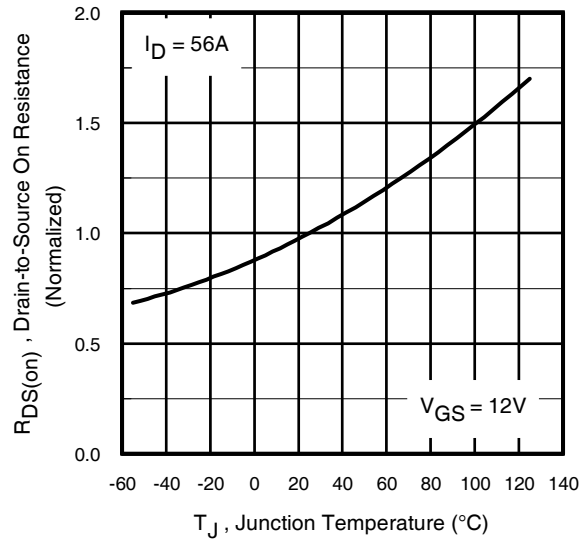

Fig 4. Normalized On-Resistance Vs. Temperature

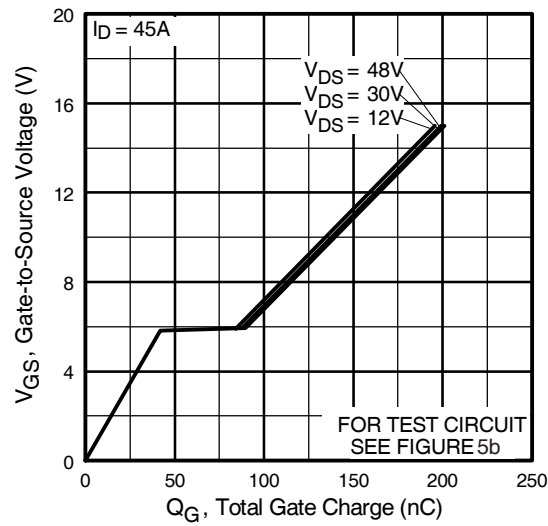

Fig 5. Typical Gate Charge Vs. Gate-to-Source Voltage

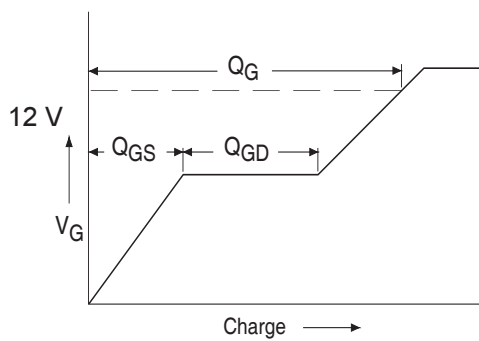

Fig 5a. Basic Gate Charge Waveform

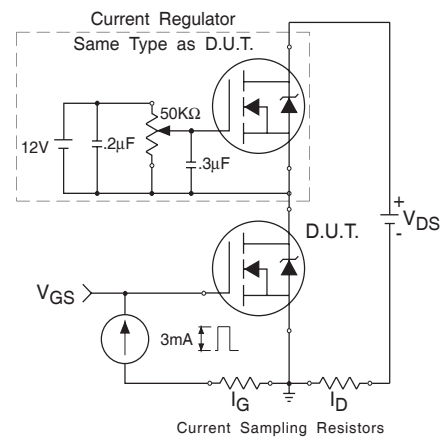

Fig 5b. Gate Charge Test Circuit

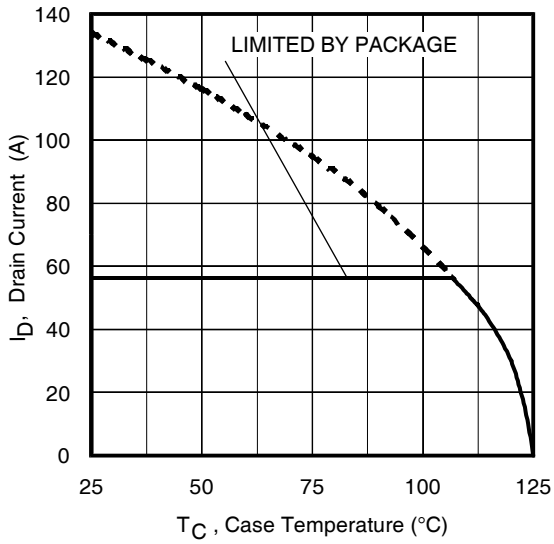

Fig 6. Maximum Drain Current Vs. Case Temperature

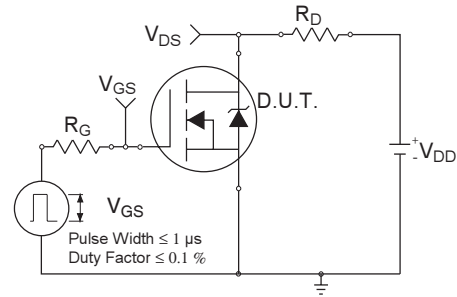

Fig 7a. Switching Time Test Circuit

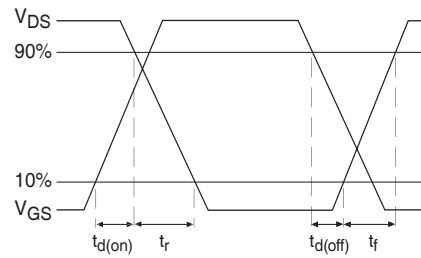

Fig 7b. Switching Time Waveforms

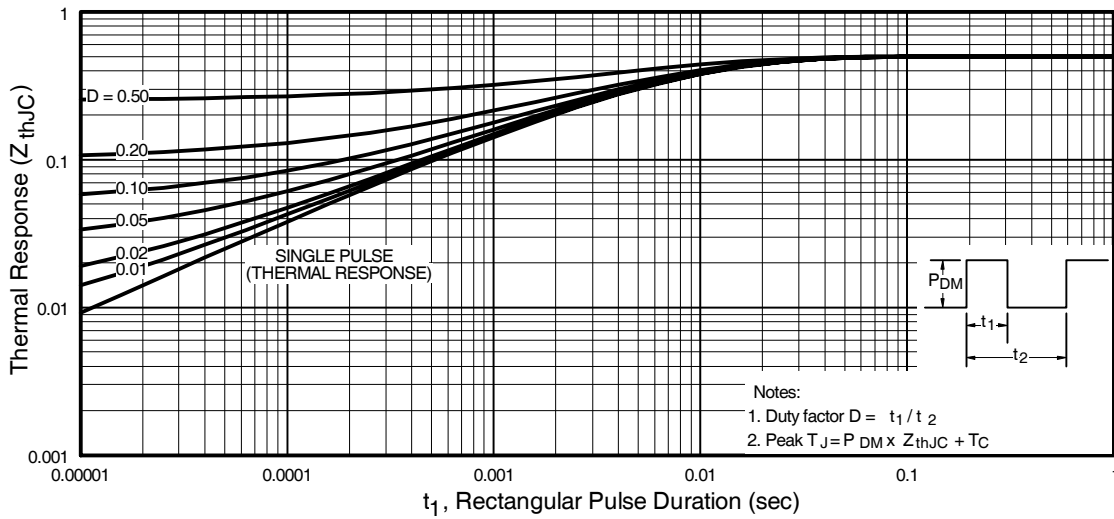

Fig 8. Maximum Effective Transient Thermal Impedance, Junction-to-Case, MOSFET

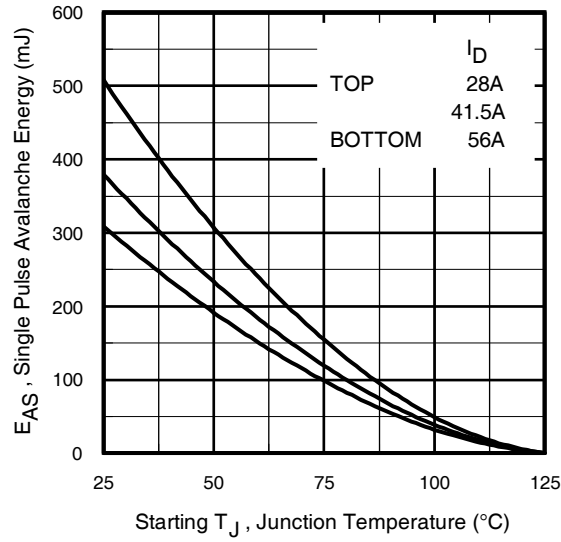

Fig 9. Maximum Avalanche Energy Vs. Drain Current

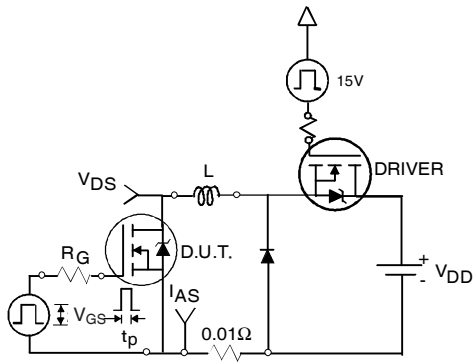

Fig 9a. Unclamped Inductive Test Circuit

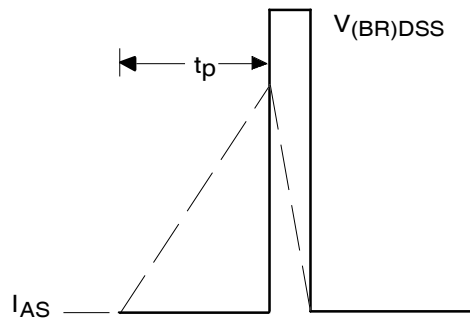

Fig 9b. Unclamped Inductive Waveforms

MOSFET Body Diode & Schottky Diode Characteristics

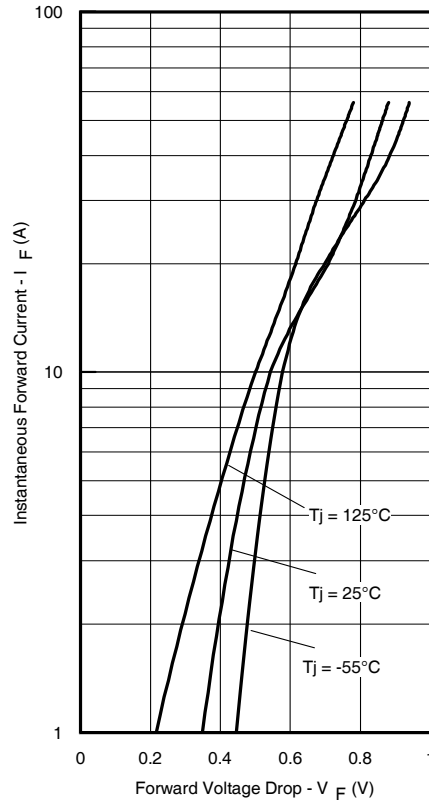

Fig. 10 - Typical Forward Voltage Drop Characteristics

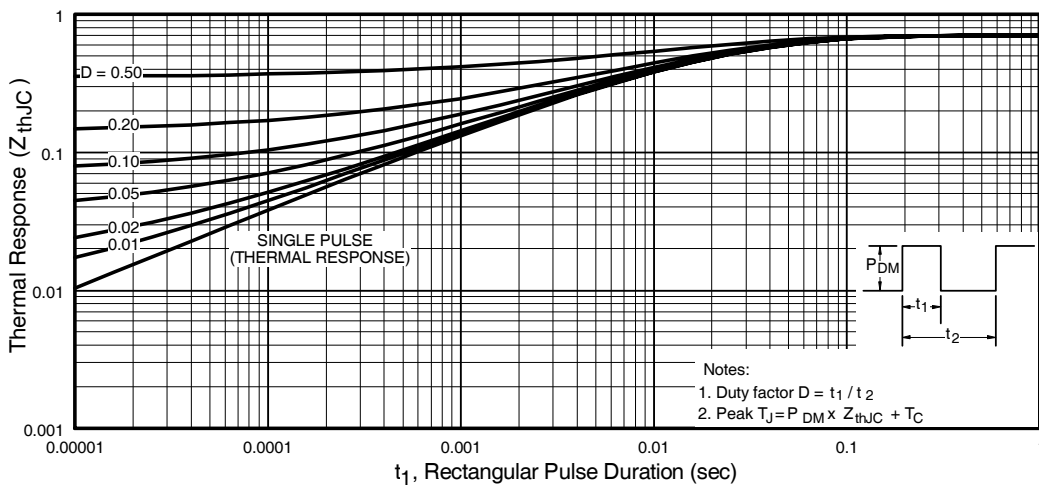

Fig 11. Maximum Effective Transient Thermal Impedance, Junction-to-Case, Schottky

Pre-Irradiation

IRHNSA57064

Footnotes:

- ① Repetitive Rating; Pulse width limited by maximum junction temperature
- ② Pulse width $\leq 300 \mu\text{s}$; Duty Cycle $\leq 2\%$
- ③ 50% Duty Cycle, Rectangular
- ④ $V_{DD} = 25\text{V}$, starting $T_J = 25^\circ\text{C}$, $L = 0.2 \text{ mH}$
Peak $I_L = 56\text{A}$, $V_{GS} = 12\text{V}$

- ⑤ **Total Dose Irradiation with V_{GS} Bias.**
12 volt V_{GS} applied and $V_{DS} = 0$ during irradiation per MIL-STD-750, method 1019, condition A.
- ⑥ **Total Dose Irradiation with V_{DS} Bias.**
48 volt V_{DS} applied and $V_{GS} = 0$ during irradiation per MIL-STD-750, method 1019, condition A.
- ⑦ Specified Radiation Characteristics are for Radiation Hardened MOSFET die only.

Case Outline and Dimensions — SMD-2

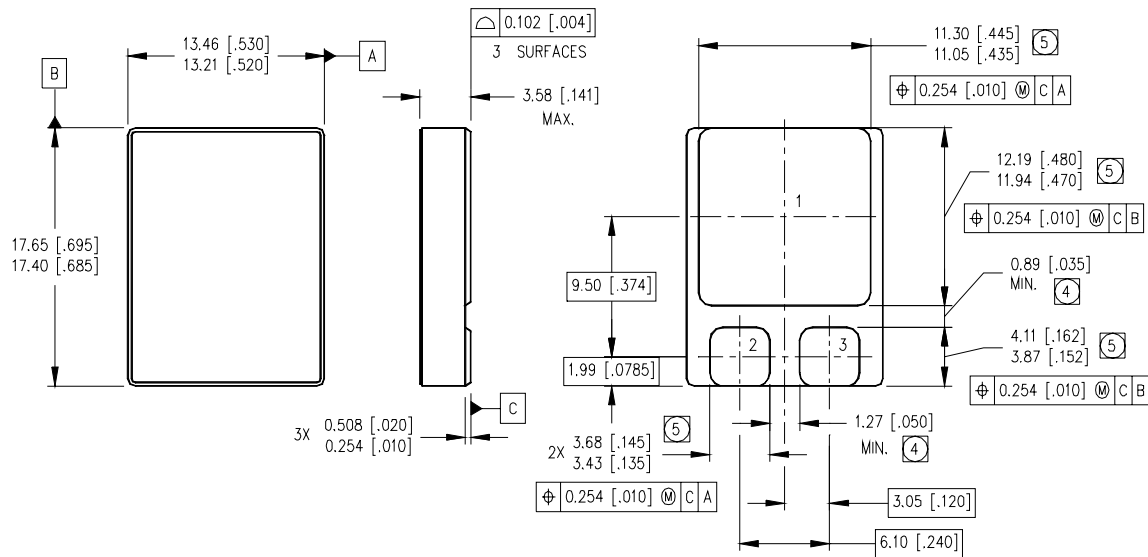

NOTES:

1. DIMENSIONING & TOLERANCING PER ASME Y14.5M-1994.
2. CONTROLLING DIMENSION: INCH.
3. DIMENSIONS ARE SHOWN IN MILLIMETERS [INCHES].

- ④ DIMENSION INCLUDES METALLIZATION FLASH.
- ⑤ DIMENSION DOES NOT INCLUDE METALLIZATION FLASH.

PAD ASSIGNMENTS

- 1 = DRAIN
- 2 = GATE
- 3 = SOURCE

International
IR Rectifier

AN INFINEON TECHNOLOGIES COMPANY

IR WORLD HEADQUARTERS: 101 N. Sepulveda Blvd., El Segundo, California 90245, USA Tel: (310) 252-7105

IR LEOMINSTER : 205 Crawford St., Leominster, Massachusetts 01453, USA Tel: (978) 534-5776

TAC Fax: (310) 252-7903

Visit us at www.irf.com for sales contact information.

Data and specifications subject to change without notice. 10/2015

www.irf.com

9