

INSULATED GATE BIPOLAR TRANSISTOR WITH ULTRAFAST SOFT RECOVERY DIODE

Features

- Low $V_{CE(on)}$ Trench IGBT Technology
- Low Switching Losses
- Maximum Junction temperature 175 °C
- 5µs SCSOA
- Square RBSOA
- 100% of the parts tested for I_{LM} ①
- Positive $V_{CE(on)}$ Temperature Coefficient.
- Ultra Fast Soft Recovery Co-pak Diode
- Tighter Distribution of Parameters
- Lead-Free, RoHS Compliant

Benefits

- High Efficiency in a Wide Range of Applications
- Suitable for a Wide Range of Switching Frequencies due to Low $V_{CE(ON)}$ and Low Switching Losses
- Rugged Transient Performance for Increased Reliability
- Excellent Current Sharing in Parallel Operation
- Low EMI

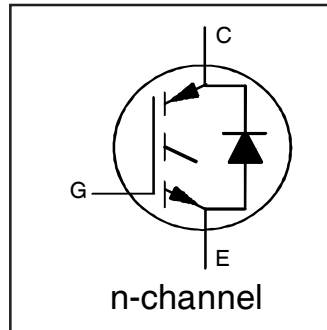

$V_{CES} = 600V$
$I_C = 6.0A, T_C = 100^\circ C$
$T_{jmax} = 175^\circ C$
$V_{CE(on) typ.} = 1.7V$

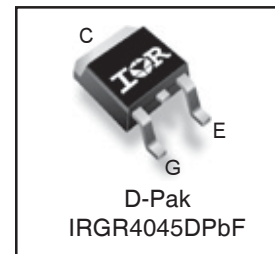

G	C	E
Gate	Collector	Emitter

Absolute Maximum Ratings

	Parameter	Max.	Units
V_{CES}	Collector-to-Emitter Breakdown Voltage	600	V
$I_C @ T_C = 25^\circ C$	Continuous Collector Current	12	A
$I_C @ T_C = 100^\circ C$	Continuous Collector Current	6.0	
I_{CM}	Pulsed Collector Current, $V_{GE} = 15V$	18	
I_{LM}	Clamped Inductive Load Current, $V_{GE} = 20V$ ①	24	
$I_F @ T_C = 25^\circ C$	Diode Continuous Forward Current	8.0	
$I_F @ T_C = 100^\circ C$	Diode Continuous Forward Current	4.0	
I_{FM}	Diode Maximum Forward Current ②	24	
V_{GE}	Continuous Gate-to-Emitter Voltage	± 20	V
	Transient Gate-to-Emitter Voltage	± 30	
$P_D @ T_C = 25^\circ$	Maximum Power Dissipation	77	W
		$P_D @ T_C = 100^\circ$	
T_J	Operating Junction and Storage Temperature Range	-55 to + 175	°C
T_{STG}			
	Soldering Temperature, for 10 seconds	300 (0.063 in. (1.6mm) from case)	

Thermal Resistance

	Parameter	Min.	Typ.	Max.	Units
$R_{\theta JC}$	Junction-to-Case - IGBT ③	---	---	1.9	°C/W
$R_{\theta JC}$	Junction-to-Case - Diode ③	---	---	6.8	
$R_{\theta JA}$	Junction-to-Ambient (PCB Mount) ⑤	---	---	50	
$R_{\theta JA}$	Junction-to-Ambient	---	---	110	

*Qualification standards can be found at <http://www.irf.com/>

Electrical Characteristics @ $T_J = 25^\circ\text{C}$ (unless otherwise specified)

	Parameter	Min.	Typ.	Max.	Units	Conditions	Ref. Fig
$V_{(BR)CES}$	Collector-to-Emitter Breakdown Voltage	600	—	—	V	$V_{GE} = 0V, I_C = 100\mu\text{A}$ ④	CT 6
$\Delta V_{(BR)CES}/\Delta T_J$	Temperature Coeff. of Breakdown Voltage	—	0.36	—	V/°C	$V_{GE} = 0V, I_C = 250\mu\text{A}$ (25 - 175 °C) ④	
$V_{CE(on)}$	Collector-to-Emitter Saturation Voltage	—	1.7	2.0	V	$I_C = 6.0A, V_{GE} = 15V, T_J = 25^\circ\text{C}$	5,6,7,9, 10,11
		—	2.07	—		$I_C = 6.0A, V_{GE} = 15V, T_J = 150^\circ\text{C}$	
		—	2.14	—		$I_C = 6.0A, V_{GE} = 15V, T_J = 175^\circ\text{C}$	
$V_{GE(th)}$	Gate Threshold Voltage	3.5	—	6.5	V	$V_{CE} = V_{GE}, I_C = 150\mu\text{A}$	9,10,11,12
$\Delta V_{GE(th)}/\Delta T_J$	Threshold Voltage temp. coefficient	—	-13	—	mV/°C	$V_{CE} = V_{GE}, I_C = 250\mu\text{A}$ (25 - 175 °C)	
g_{fe}	Forward Transconductance	—	5.8	—	S	$V_{CE} = 25V, I_C = 6.0A, PW = 80\mu\text{s}$	
I_{CES}	Collector-to-Emitter Leakage Current	—	—	25	μA	$V_{GE} = 0V, V_{CE} = 600V$	8
		—	—	250		$V_{GE} = 0V, V_{CE} = 600V, T_J = 175^\circ\text{C}$	
V_{FM}	Diode Forward Voltage Drop	—	1.60	2.30	V	$I_F = 6.0A$	
		—	1.30	—		$I_F = 6.0A, T_J = 175^\circ\text{C}$	
I_{GES}	Gate-to-Emitter Leakage Current	—	—	± 100	nA	$V_{GE} = \pm 20V$	

Switching Characteristics @ $T_J = 25^\circ\text{C}$ (unless otherwise specified)

	Parameter	Min.	Typ.	Max. ⑥	Units	Conditions	Ref. Fig
Q_g	Total Gate Charge (turn-on)	—	13	19.5	nC	$I_C = 6.0A$	24
Q_{ge}	Gate-to-Emitter Charge (turn-on)	—	3.1	4.65		$V_{CC} = 400V$	CT 1
Q_{gc}	Gate-to-Collector Charge (turn-on)	—	6.4	9.6		$V_{GE} = 15V$	
E_{on}	Turn-On Switching Loss	—	56	86	μJ	$I_C = 6.0A, V_{CC} = 400V, V_{GE} = 15V$	CT 4
E_{off}	Turn-Off Switching Loss	—	122	143		$R_G = 47\Omega, L = 1\text{mH}, L_S = 150\text{nH}, T_J = 25^\circ\text{C}$	
E_{total}	Total Switching Loss	—	178	229		Energy losses include tail and diode reverse recovery	
$t_{d(on)}$	Turn-On delay time	—	27	35	ns	$I_C = 6.0A, V_{CC} = 400V$	CT 4
t_r	Rise time	—	11	15		$R_G = 47\Omega, L = 1\text{mH}, L_S = 150\text{nH}$	
$t_{d(off)}$	Turn-Off delay time	—	75	93		$T_J = 25^\circ\text{C}$	
t_f	Fall time	—	17	22			
E_{on}	Turn-On Switching Loss	—	140	—	μJ	$I_C = 6.0A, V_{CC} = 400V, V_{GE} = 15V$	13,15
E_{off}	Turn-Off Switching Loss	—	189	—		$R_G = 47\Omega, L = 1\text{mH}, L_S = 150\text{nH}, T_J = 175^\circ\text{C}$	CT 4
E_{total}	Total Switching Loss	—	329	—		Energy losses include tail and diode reverse recovery	WF 1, WF 2
$t_{d(on)}$	Turn-On delay time	—	26	—	ns	$I_C = 6.0A, V_{CC} = 400V$	14,16
t_r	Rise time	—	12	—		$R_G = 47\Omega, L = 1\text{mH}, L_S = 150\text{nH}$	CT 4
$t_{d(off)}$	Turn-Off delay time	—	95	—		$T_J = 175^\circ\text{C}$	WF 1, WF 2
t_f	Fall time	—	32	—			
C_{ies}	Input Capacitance	—	350	—	pF	$V_{GE} = 0V$	23
C_{oes}	Output Capacitance	—	29	—		$V_{CC} = 30V$	
C_{res}	Reverse Transfer Capacitance	—	10	—		$f = 1\text{Mhz}$	
RBSOA	Reverse Bias Safe Operating Area	FULL SQUARE				$T_J = 175^\circ\text{C}, I_C = 24A$ $V_{CC} = 500V, V_p = 600V$ $R_G = 100\Omega, V_{GE} = +20V \text{ to } 0V$	4 CT 2
SCSOA	Short Circuit Safe Operating Area	—	5	—	μs	$V_{CC} = 400V, V_p = 600V$ $R_G = 100\Omega, V_{GE} = +15V \text{ to } 0V$	22 CT 3, WF 4
E_{rec}	Reverse recovery energy of the diode	—	178	—	μJ	$T_J = 175^\circ\text{C}$	17,18,19
t_{rr}	Diode Reverse recovery time	—	74	—	ns	$V_{CC} = 400V, I_F = 6.0A$	20,21
I_{rr}	Peak Reverse Recovery Current	—	12	—	A	$V_{GE} = 15V, R_G = 47\Omega, L = 1\text{mH}, L_S = 150\text{nH}$	WF 3

Notes:

- ① $V_{CC} = 80\% (V_{CES}), V_{GE} = 15V, L = 1.0\text{mH}, R_G = 47\Omega.$
- ② Pulse width limited by max. junction temperature.
- ③ R_θ is measured at T_J approximately $90^\circ\text{C}.$
- ④ Refer to AN-1086 for guidelines for measuring $V_{(BR)CES}$ safely.
- ⑤ When mounted on 1" square PCB (FR-4 or G-10 Material). For recommended footprint and soldering techniques refer to application note #AN-994.
- ⑥ Maximum limits are based on statistical sample size characterization.

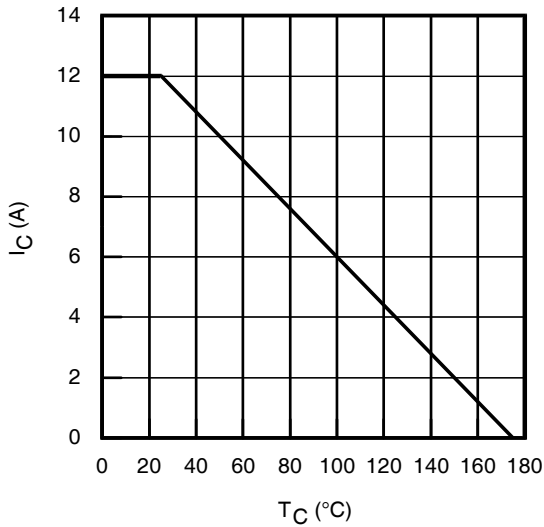

Fig. 1 - Maximum DC Collector Current vs. Case Temperature

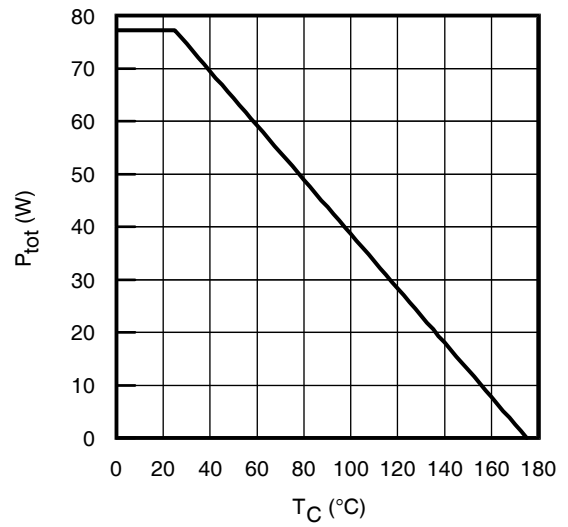

Fig. 2 - Power Dissipation vs. Case Temperature

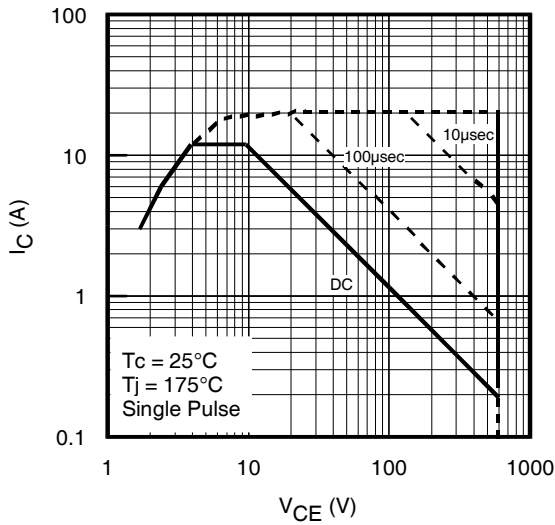

Fig. 3 - Forward SOA,
 $T_C = 25^\circ\text{C}$, $T_J \leq 175^\circ\text{C}$, $V_{GE} = 15\text{V}$

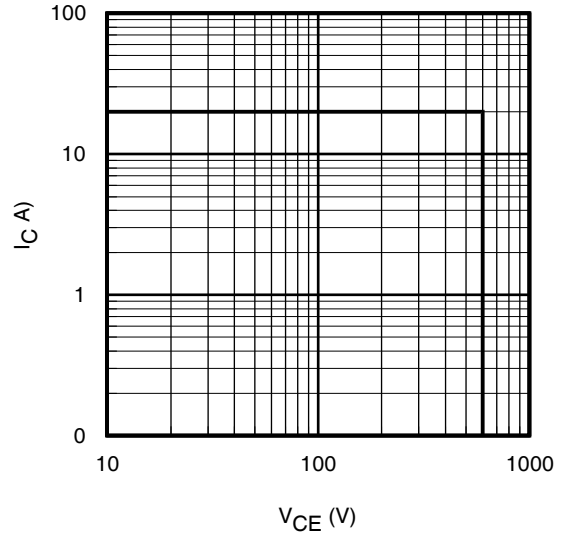

Fig. 4 - Reverse Bias SOA
 $T_J = 175^\circ\text{C}$, $V_{GE} = 20\text{V}$

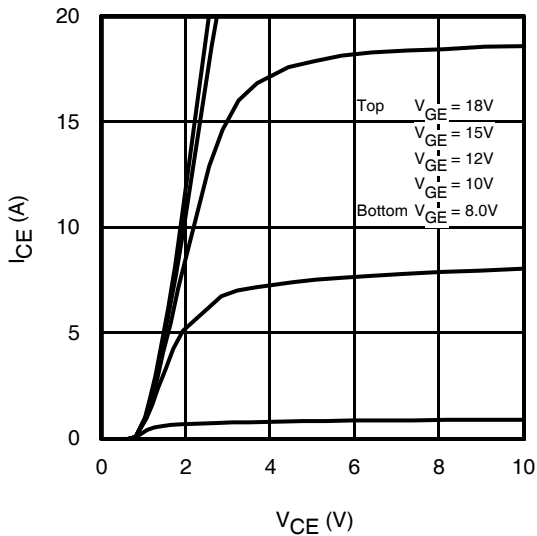

Fig. 5 - Typ. IGBT Output Characteristics
 $T_J = -40^\circ\text{C}$; $t_p = 80\mu\text{s}$

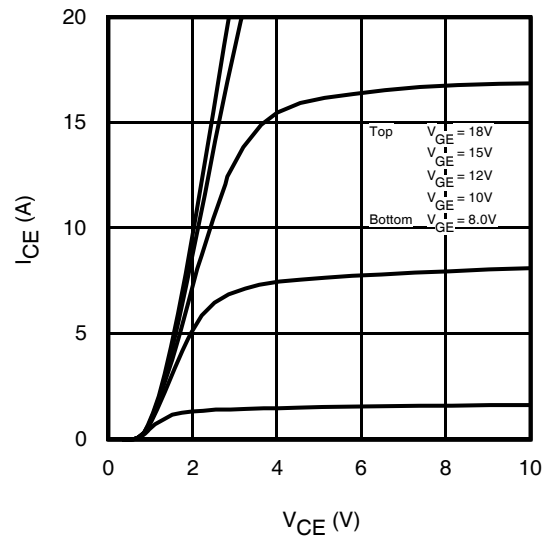

Fig. 6 - Typ. IGBT Output Characteristics
 $T_J = 25^\circ\text{C}$; $t_p = 80\mu\text{s}$

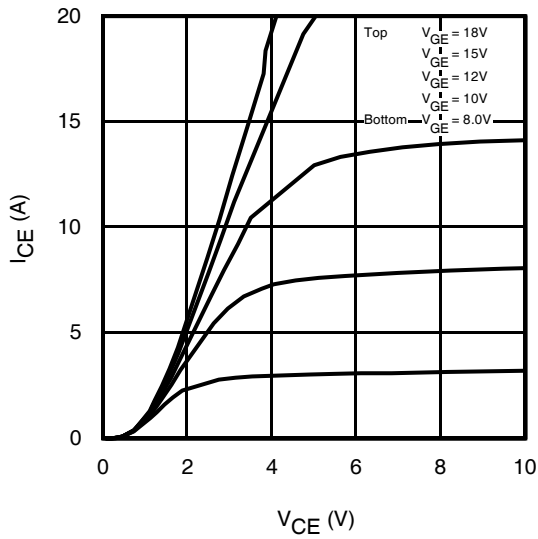

Fig. 7 - Typ. IGBT Output Characteristics
 $T_J = 175^\circ\text{C}$; $t_p = 80\mu\text{s}$

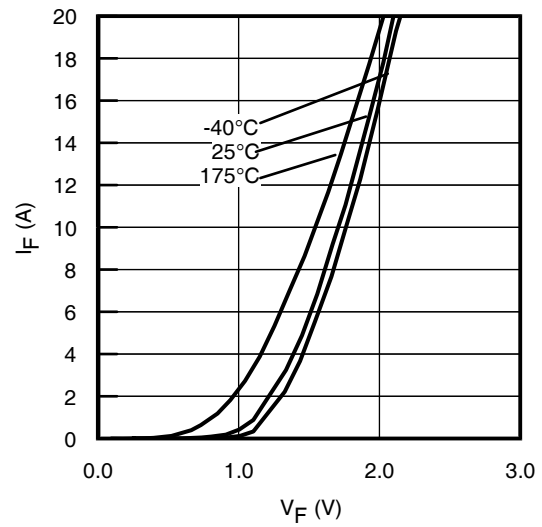

Fig. 8 - Typ. Diode Forward Characteristics
 $t_p = 80\mu\text{s}$

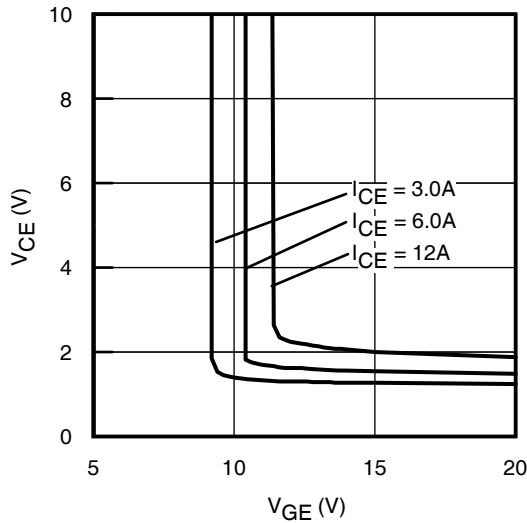

Fig. 9 - Typical V_{CE} vs. V_{GE}
 $T_J = -40^\circ\text{C}$

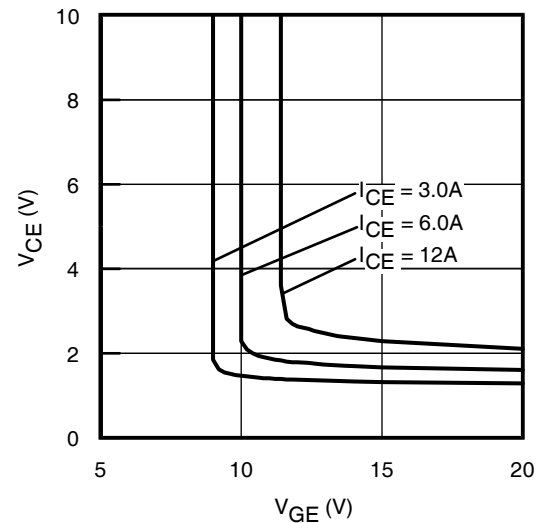

Fig. 10 - Typical V_{CE} vs. V_{GE}
 $T_J = 25^\circ\text{C}$

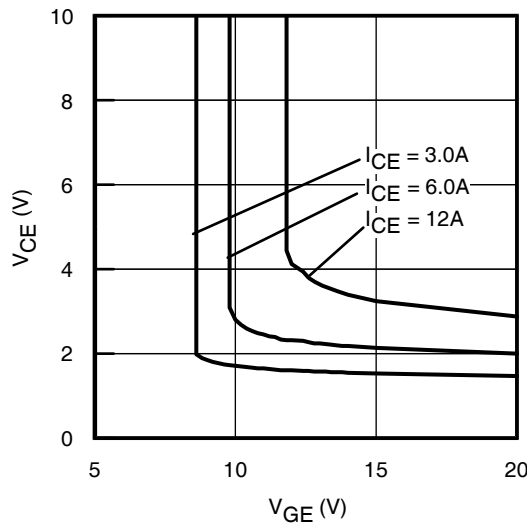

Fig. 11 - Typical V_{CE} vs. V_{GE}
 $T_J = 175^\circ\text{C}$

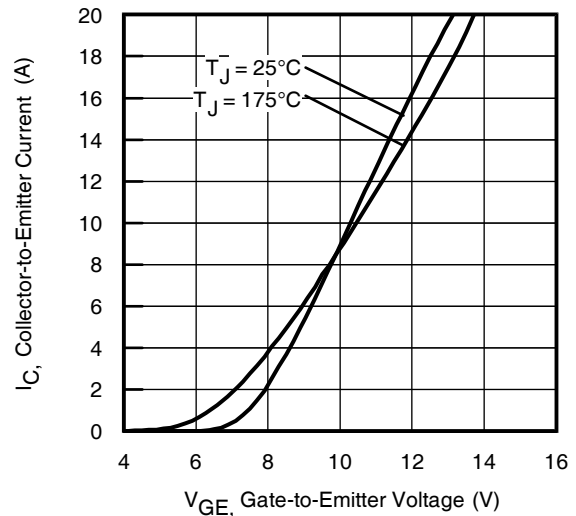

Fig. 12 - Typ. Transfer Characteristics
 $V_{CE} = 50\text{V}$; $t_p = 10\mu\text{s}$

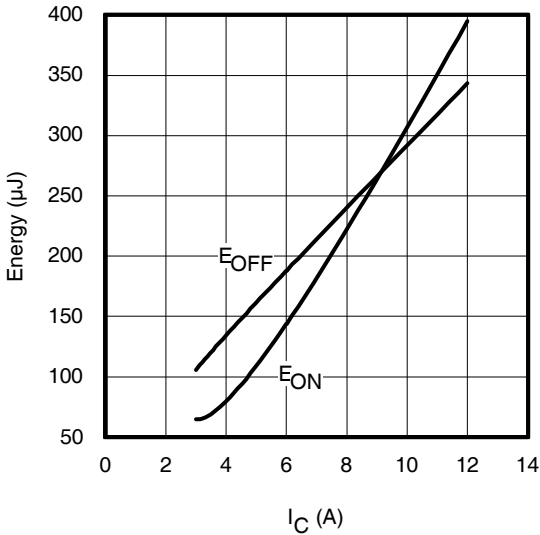

Fig. 13 - Typ. Energy Loss vs. I_C
 $T_J = 175^\circ\text{C}$; $L = 1\text{mH}$; $V_{CE} = 400\text{V}$; $R_G = 47\Omega$; $V_{GE} = 15\text{V}$.

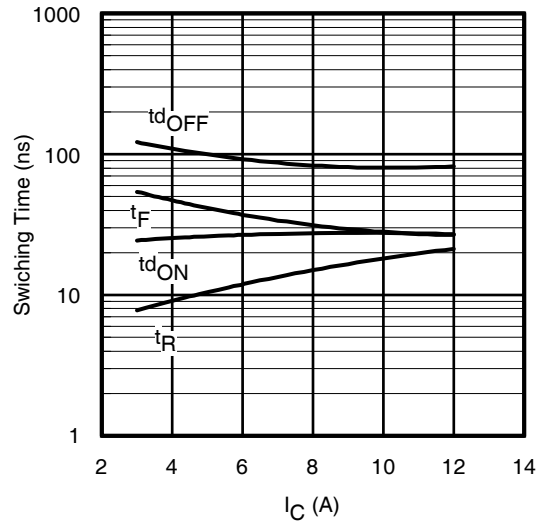

Fig. 14 - Typ. Switching Time vs. I_C
 $T_J = 175^\circ\text{C}$; $L = 1\text{mH}$; $V_{CE} = 400\text{V}$
 $R_G = 47\Omega$; $V_{GE} = 15\text{V}$

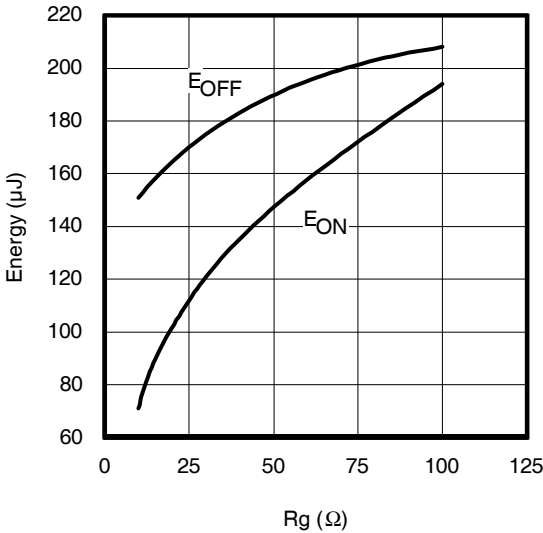

Fig. 15 - Typ. Energy Loss vs. R_G
 $T_J = 175^\circ\text{C}$; $L = 1\text{mH}$; $V_{CE} = 400\text{V}$; $I_{CE} = 6.0\text{A}$; $V_{GE} = 15\text{V}$

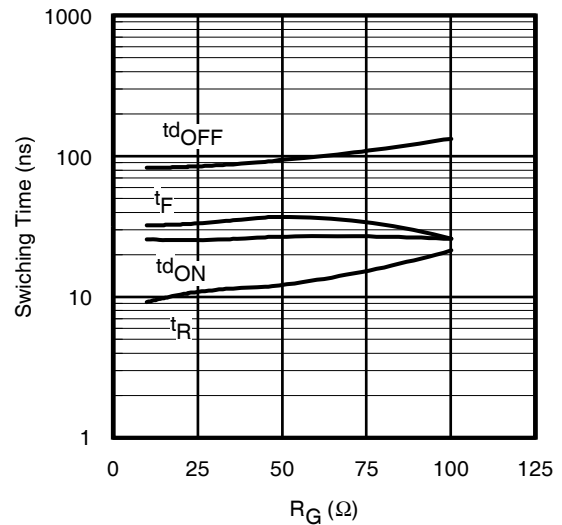

Fig. 16 - Typ. Switching Time vs. R_G
 $T_J = 175^\circ\text{C}$; $L = 1\text{mH}$; $V_{CE} = 400\text{V}$
 $I_{CE} = 6.0\text{A}$; $V_{GE} = 15\text{V}$

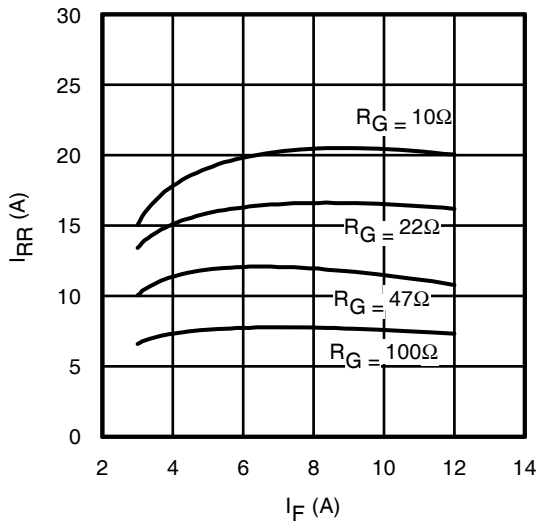

Fig. 17 - Typical Diode I_{RR} vs. I_F
 $T_J = 175^\circ\text{C}$

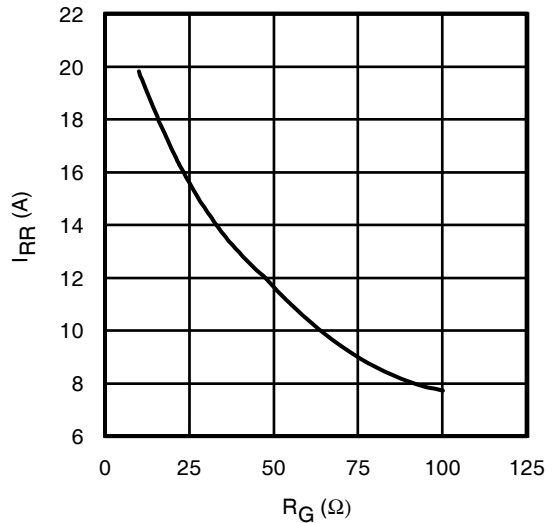

Fig. 18 - Typical Diode I_{RR} vs. R_G
 $T_J = 175^\circ\text{C}$; $I_F = 6.0\text{A}$

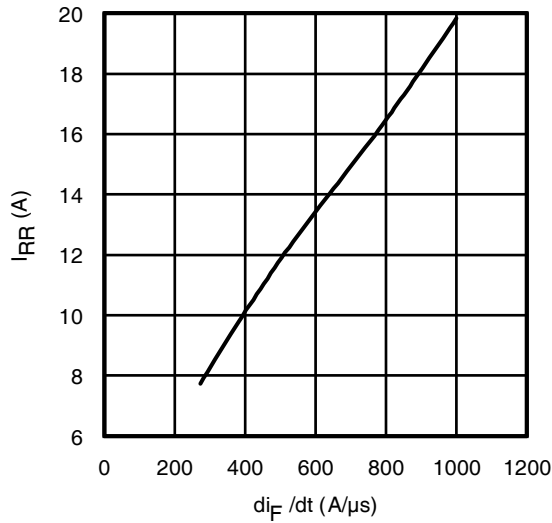

Fig. 19- Typical Diode I_{RR} vs. di_F/dt
 $V_{CC}=400V$; $V_{GE}=15V$;
 $I_{CE}=6.0A$; $T_J=175^\circ C$

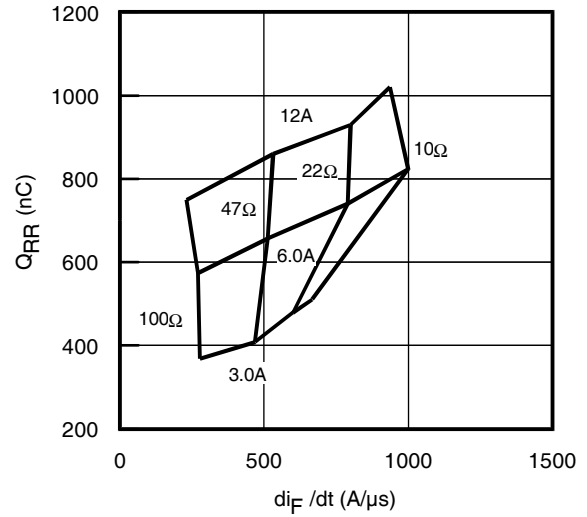

Fig. 20 - Typical Diode Q_{RR}
 $V_{CC}=400V$; $V_{GE}=15V$; $T_J=175^\circ C$

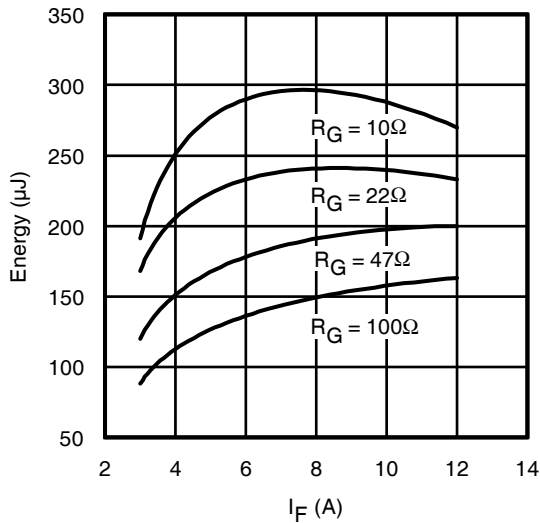

Fig. 21 - Typical Diode E_{RR} vs. I_F
 $T_J=175^\circ C$

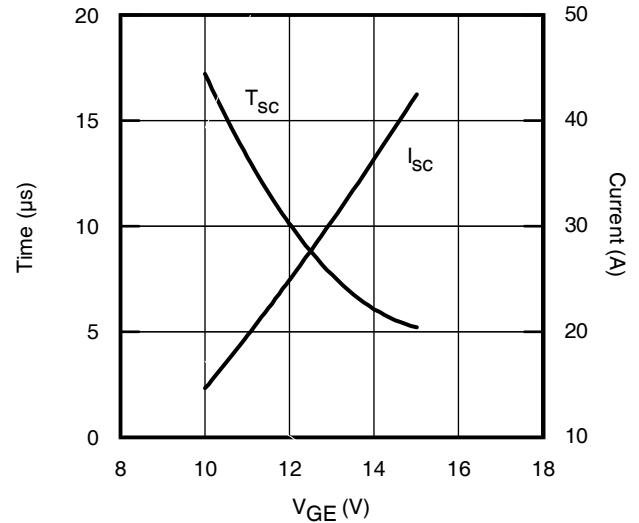

Fig. 22- Typ. V_{GE} vs. Short Circuit Time
 $V_{CC}=400V$, $T_C=25^\circ C$

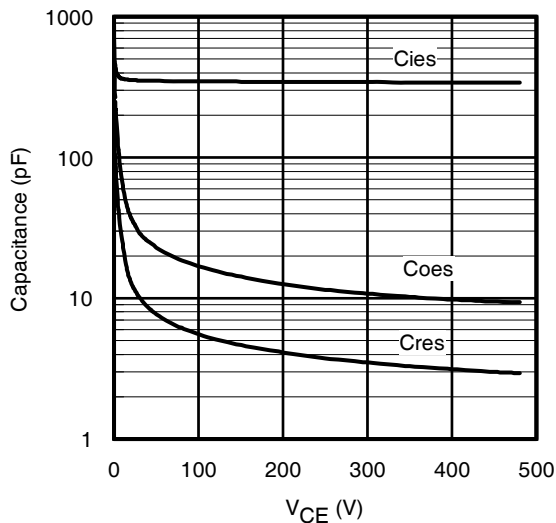

Fig. 23- Typ. Capacitance vs. V_{CE}
 $V_{GE}=0V$; $f=1MHz$

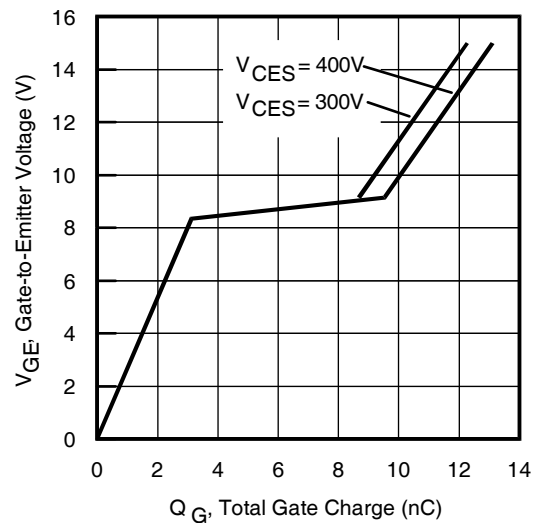

Fig. 24 - Typical Gate Charge vs. V_{GE}
 $I_{CE}=6.0A$, $L=600\mu H$

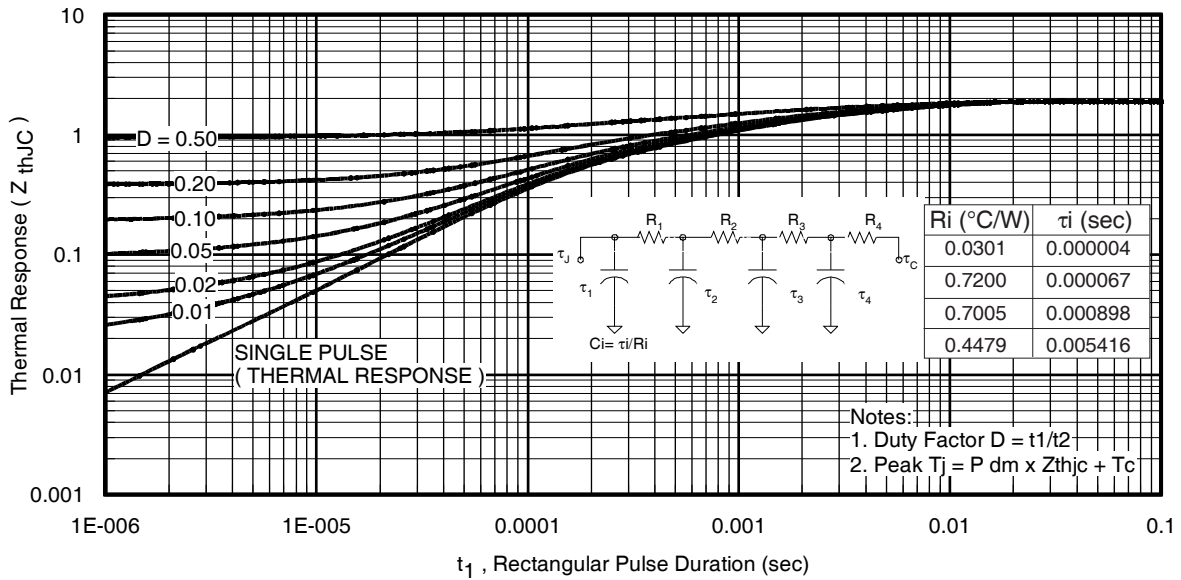

Fig 25. Maximum Transient Thermal Impedance, Junction-to-Case (IGBT)

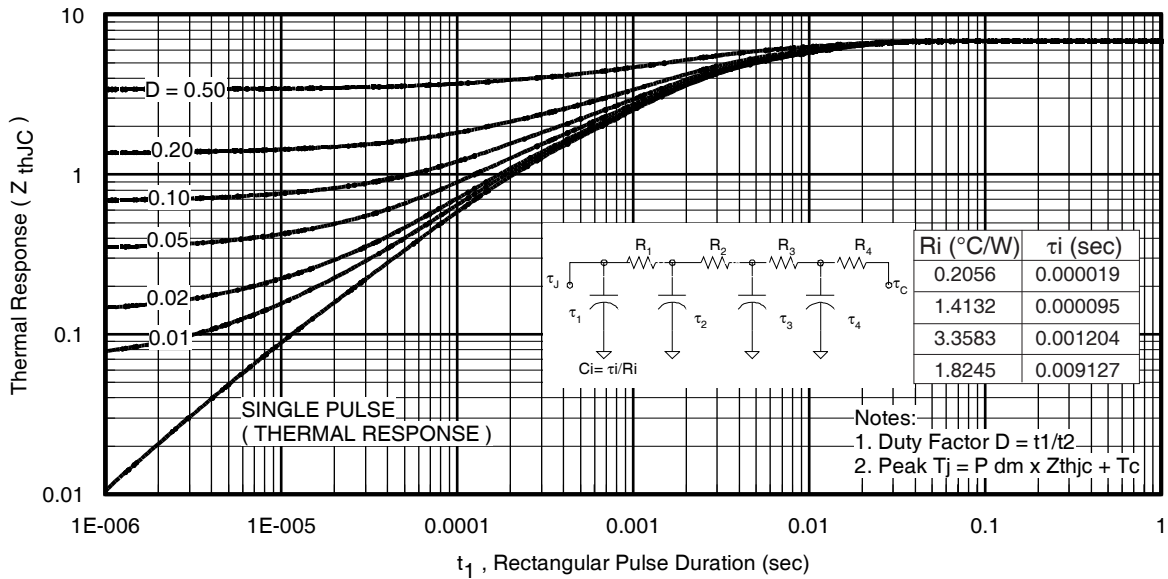

Fig. 26. Maximum Transient Thermal Impedance, Junction-to-Case (DIODE)

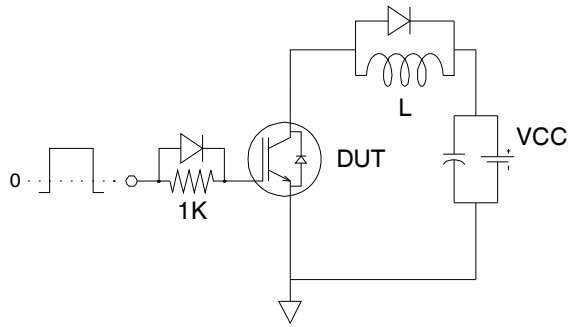

Fig.C.T.1 - Gate Charge Circuit (turn-off)

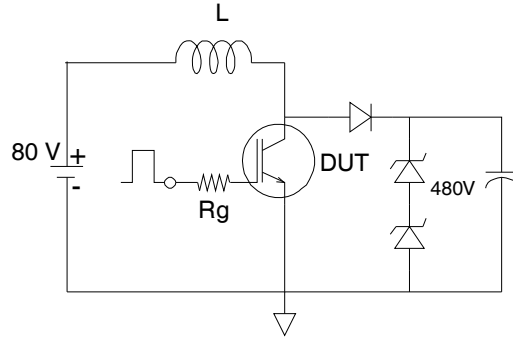

Fig.C.T.2 - RBSOA Circuit

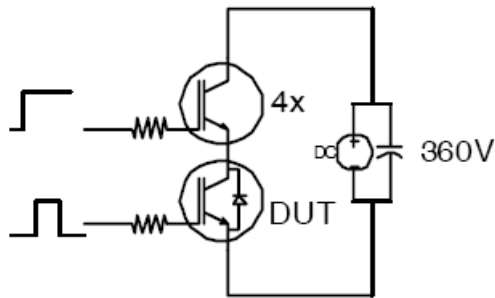

Fig.C.T.3 - S.C.SOA Circuit

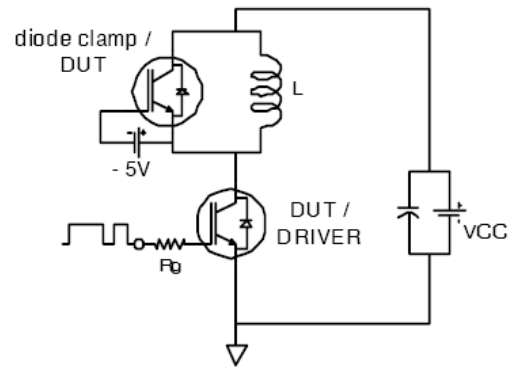

Fig.C.T.4 - Switching Loss Circuit

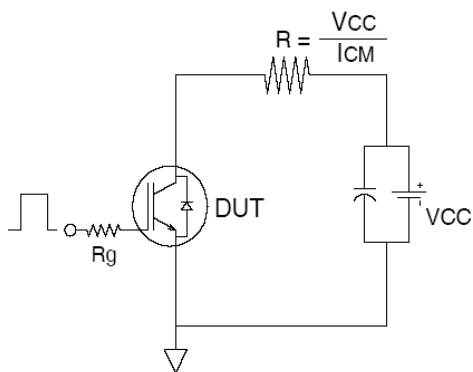

Fig.C.T.5 - Resistive Load Circuit

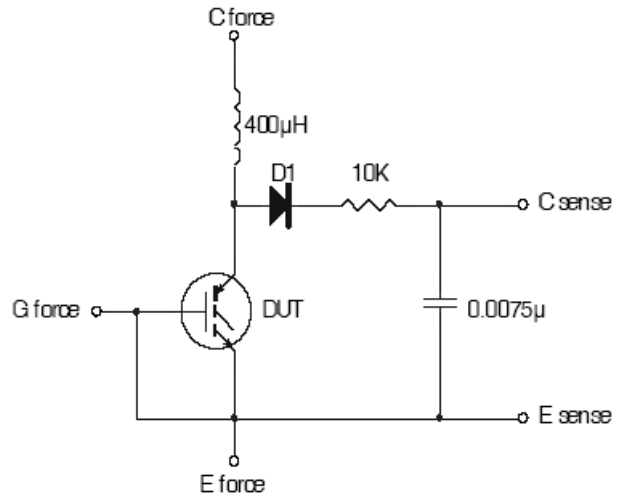

Fig.C.T.6 - Typical Filter Circuit for $V_{(BR)CES}$ Measurement

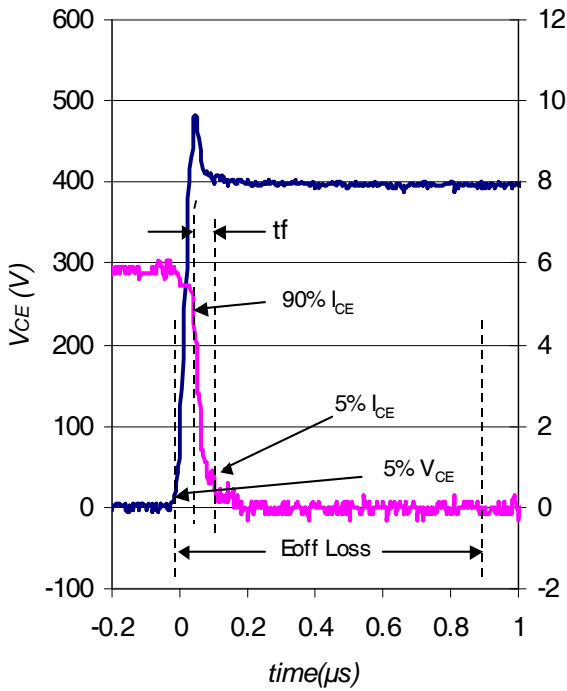

Fig. WF1 - Typ. Turn-off Loss Waveform
@ $T_J = 175^\circ\text{C}$ using Fig. CT.4

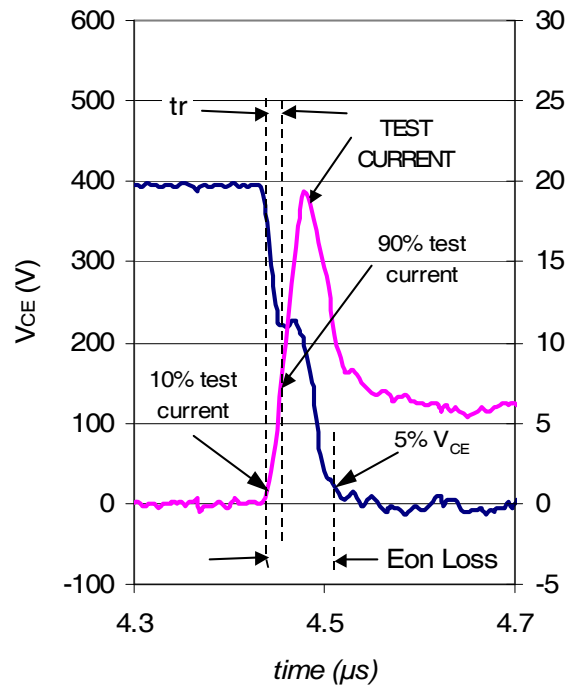
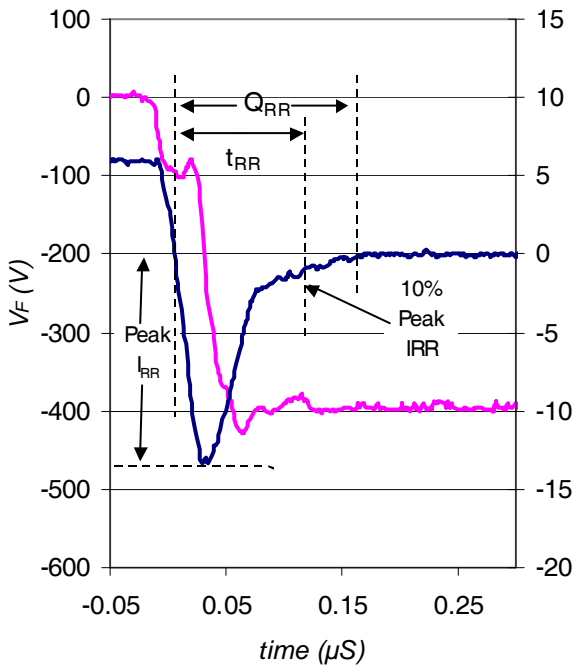
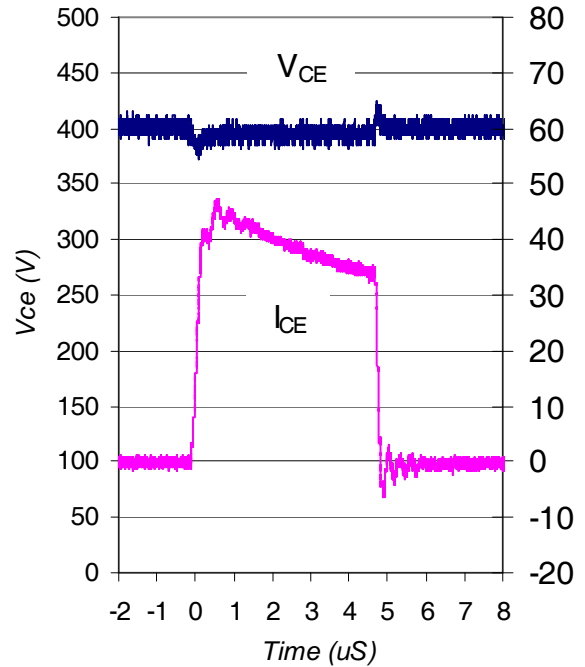

Fig. WF2 - Typ. Turn-on Loss Waveform
@ $T_J = 175^\circ\text{C}$ using Fig. CT.4



WF.3- Typ. Diode Recovery Waveform
@ $T_J = 175^\circ\text{C}$ using CT.4



WF.4- Typ. Short Circuit Waveform
@ $T_J = 25^\circ\text{C}$ using CT.3

D-Pak (TO-252AA) Package Outline

Dimensions are shown in millimeters (inches)

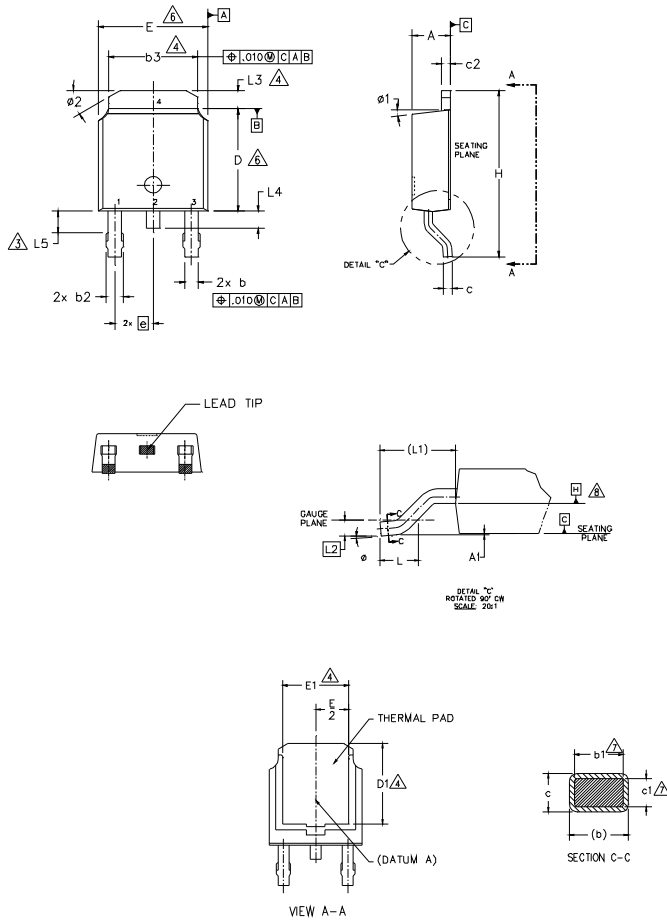

NOTES:

- 1.- DIMENSIONING AND TOLERANCING PER ASME Y14.5M-1994
- 2.- DIMENSION ARE SHOWN IN INCHES [MILLIMETERS]
- △- LEAD DIMENSION UNCONTROLLED IN L5.
- △- DIMENSION D1, E1, L3 & b3 ESTABLISH A MINIMUM MOUNTING SURFACE FOR THERMAL PAD.
- 5.- SECTION C-C DIMENSIONS APPLY TO THE FLAT SECTION OF THE LEAD BETWEEN .005 AND 0.10 [0.13 AND 0.25] FROM THE LEAD TIP.
- △- DIMENSION D & E DO NOT INCLUDE MOLD FLASH. MOLD FLASH SHALL NOT EXCEED .005 [0.13] PER SIDE. THESE DIMENSIONS ARE MEASURED AT THE OUTMOST EXTREMES OF THE PLASTIC BODY.
- △- DIMENSION b1 & c1 APPLIED TO BASE METAL ONLY.
- △- DATUM A & B TO BE DETERMINED AT DATUM PLANE H.
- 9.- OUTLINE CONFORMS TO JEDEC OUTLINE TO-252AA.

SYMBOL	DIMENSIONS				NOTES
	MILLIMETERS		INCHES		
	MIN.	MAX.	MIN.	MAX.	
A	2.18	2.39	.086	.094	
A1	-	0.13	-	.005	
b	0.64	0.89	.025	.035	
b1	0.65	0.79	.025	.031	7
b2	0.76	1.14	.030	.045	
b3	4.95	5.46	.195	.215	4
c	0.46	0.61	.018	.024	
c1	0.41	0.56	.016	.022	7
c2	0.46	0.89	.018	.035	
D	5.97	6.22	.235	.245	6
D1	5.21	-	.205	-	4
E	6.35	6.73	.250	.265	6
E1	4.32	-	.170	-	4
e	2.29 BSC		.090 BSC		
H	9.40	10.41	.370	.410	
L	1.40	1.78	.055	.070	
L1	2.74 BSC		.108 REF.		
L2	0.51 BSC		.020 BSC		
L3	0.89	1.27	.035	.050	4
L4	-	1.02	-	.040	
L5	1.14	1.52	.045	.060	3
φ	0"	10"	0"	10"	
φ1	0"	15"	0"	15"	
φ2	25"	35"	25"	35"	

LEAD ASSIGNMENTS

HEXFET

- 1.- GATE
- 2.- DRAIN
- 3.- SOURCE
- 4.- DRAIN

IGBT & CoPAK

- 1.- GATE
- 2.- COLLECTOR
- 3.- EMITTER
- 4.- COLLECTOR

D-Pak (TO-252AA) Part Marking Information

Notes: This part marking information applies to devices produced before 02/26/2001

EXAMPLE: THIS IS AN IRFR120
WITH ASSEMBLY
LOT CODE 9U1P

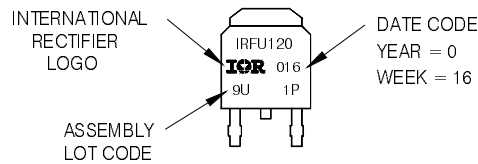

Notes: This part marking information applies to devices produced after 02/26/2001

EXAMPLE: THIS IS AN IRFR120
WITH ASSEMBLY
LOT CODE 1234
ASSEMBLED ON WW 16, 1999
IN THE ASSEMBLY LINE 'A'

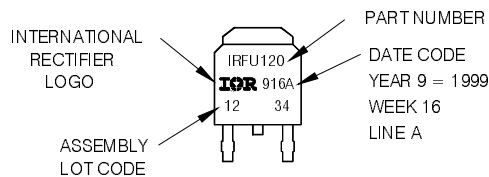

Note: For the most current drawing please refer to IR website at <http://www.irf.com/package/>

D-Pak (TO-252AA) Tape & Reel Information

Dimensions are shown in millimeters (inches)

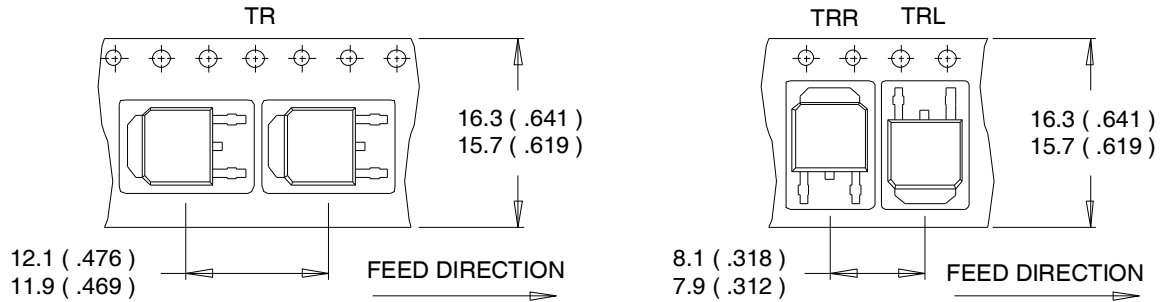

NOTES :

1. CONTROLLING DIMENSION : MILLIMETER.
2. ALL DIMENSIONS ARE SHOWN IN MILLIMETERS (INCHES).
3. OUTLINE CONFORMS TO EIA-481 & EIA-541.

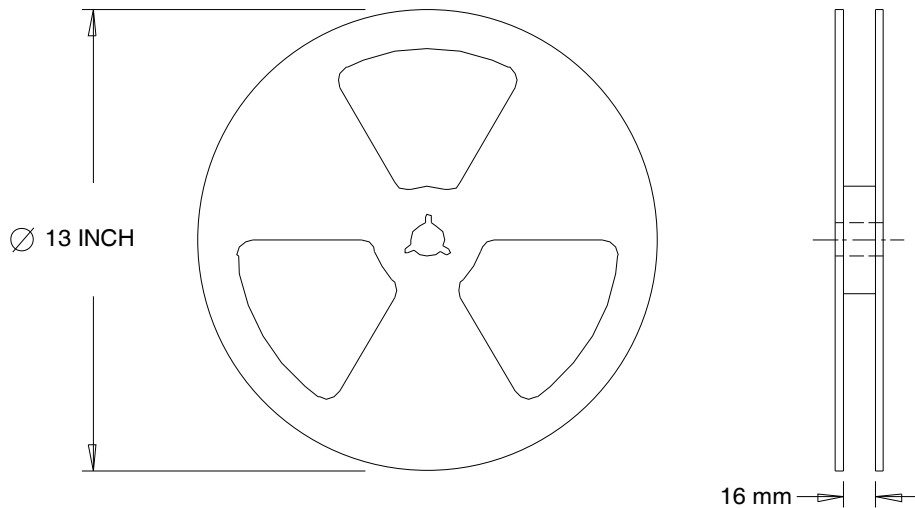

NOTES :

1. OUTLINE CONFORMS TO EIA-481.

Data and specifications subject to change without notice.
 This product has been designed and qualified for the Industrial market.
 Qualification Standards can be found on IR's Web site.