

T496 Space Grade High Reliability Alternative (HRA) Fail-Safe Fused MnO₂

Overview

KEMET's Space Grade capacitors are suitable for use by the defense/aerospace customers in high reliability space applications. These capacitors meet the requirements of MIL-PRF-55365 as well as MIL-STD-1580. These capacitors incorporate an intensive testing and screening protocol which is customizable depending upon customer's specific needs.

The full part number allows for designation of surge current level (10 cycles -55°C and +85°C before and/or after Weibull grading, 10 cycles +25°C), performance testing level (see chart for details on available options), ESR (low and standard), and termination finish (see description in each series). Fused versions are available for built-in circuit protection, as well as multi-anode designs for very low ESR values.

Benefits

- Internal fuse protects against damaging short circuit failure mode
- Standard case sizes B, C, D, X per EIA 535BAAC
- 100% surge current test available
- Optional gold-plated terminations
- Fuse activation, 25°C: within 1 second at fault currents of 4 amps and higher
- Continuous current capability: 0.75 amps
- Post actuation resistance, 25°C: 10 MΩ, minimum
- Test tabs on side of case bypass the capacitor element to allow direct testing of the fuse assembly
- Weibull Grading C (0.01%/1,000 hours)

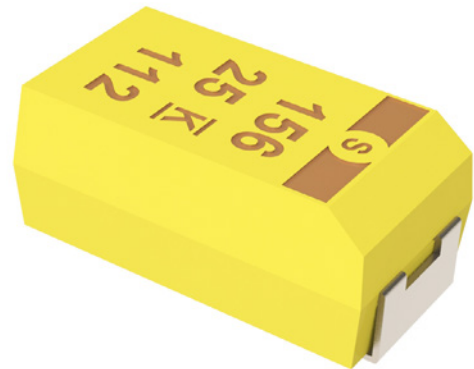

Environmental Compliance

- Halogen-free
- Epoxy compliant with UL94 V-0
- Molded Epoxy complies for outgassing testing under ASTM E 595.

K-SIM

For a detailed analysis of specific part numbers, please visit ksim.kemet.com to access KEMET's K-SIM software. KEMET K-SIM is designed to simulate behavior of components with respect to frequency, ambient temperature, and DC bias levels.

Ordering Information

T	496	X	227	K	010	C	H	63	2	A	
Capacitor Class	Series	Case Size	Capacitance Code (pF)	Capacitance Tolerance	Voltage (V)	Failure Rate/Design	Lead Material	Surge	ESR	Testing	Packaging (C-Spec)
T = Tantalum	Fail safe - Space grade	B C D X	First two digits represent significant figures. Third digit specifies number of zeros.	K = ±10% M = ±20%	004 = 4 006 = 6.3 010 = 10 016 = 16 020 = 20 025 = 25 035 = 35 050 = 50	C = 0.01% /1,000 hours	C = Hot solder dipped H = Standard solder-coated (SnPb 5% Pb minimum) T = 100% Matte Tin (Sn) plated	61 = No Surge 62 = 10 Cycles after Weibull, 25°C 63 = 10 Cycles, after Weibull, -55°C and 85°C 64 = 10 Cycles before Weibull, -55°C and 85°C 65 = 10 Cycles before and after Weibull, -55°C and 85°C	1 = ESR - standard 2 = ESR - low	A = Option A B = Option B C = Option C	Blank = 7" Reel 7280 = 13" Reel 7610 = Bulk bag 7640 = Bulk plastic box WAFI = Waffle pack

Performance Characteristics

Item	Performance Characteristics
Operating Temperature	-55°C to 125°C
Rated Capacitance Range	0.15 – 470 µF at 120 Hz/25°C
Capacitance Tolerance	K Tolerance (10%), M Tolerance (20%)
Rated Voltage Range	4 – 50 V
DF (120 Hz)	Refer to Part Number Electrical Specification Table
ESR (100 kHz)	Refer to Part Number Electrical Specification Table
Leakage Current	≤ 0.01 CV (µA) at rated voltage after 5 minutes

Qualification

Test	Condition	Characteristics				
Endurance	85°C at rated voltage, 2,000 hours 125°C at 2/3 rated voltage, 2,000 hours	Δ C/C	Within ±10% of initial value			
		DF	Within initial limits			
		DCL	Within 1.25 x initial limit			
		ESR	Within initial limits			
Storage Life	125°C at 0 Volts, 2,000 hours	Δ C/C	Within ±10% of initial value			
		DF	Within initial limits			
		DCL	Within 1.25 x initial limit			
		ESR	Within initial limits			
Thermal Shock	MIL-STD-202, Method 107, Condition B, mounted, -55°C to 125°C, 1,000 cycles	Δ C/C	Within ±5% of initial value			
		DF	Within initial limits			
		DCL	Within 1.25 x initial limit			
		ESR	Within initial limits			
Temperature Stability	Extreme temperature exposure at a succession of continuous steps at +25°C, -55°C, +25°C, +85°C, +125°C, +25°C		+25°C	-55°C	+85°C	+125°C
		Δ C/C	IL*	±10%	±10%	±20%
		DF	IL	IL	1.5 x IL	1.5 x IL
		DCL	IL	n/a	10 x IL	12 x IL
Surge Voltage	25°C and 85°C, 1.32 x rated voltage 1,000 cycles. (125°C, 1.2 x rated voltage)	Δ C/C	Within ±5% of initial value			
		DF	Within initial limits			
		DCL	Within initial limits			
		ESR	Within initial limits			
Mechanical Shock/ Vibration	MIL-STD-202, Method 213, Condition I, 100 G peak. MIL-STD-202, Method 204, Condition D, 10 Hz to 2,000 Hz, 20 G peak	Δ C/C	Within ±10% of initial value			
		DF	Within initial limits			
		DCL	Within initial limits			

*IL = Initial Limit

Certification

DSCC Drawing 04053

Test Methods

Test Sequence	Test Method	Option A	Option B	Option C
100% Serialization	KEMET Standard			X
100% IR Reflow	MIL-PRF-55365	X	X	X
100% Thermal Shock	MIL-PRF-55365	X	X	X
100% Electrical Verification	KEMET Standard			X
Read and Record Attributes/Variables Data	KEMET Standard			X
100% Surge Current, Option C with 5% PDA Calculation	MIL-PRF-55365 with 5% PDA Calculation	X	X	X
100% Electrical Verification	KEMET Standard	X	X	X
Read and Record Attributes/Variables Data	KEMET Standard			X
100% Voltage Aging, 10 hours at 1.32 Vr	MIL-PRF-55365	X	X	X
100% Electrical Verification	KEMET Standard	X	X	X
100% Weibull Grading C	MIL-PRF-55365	X	X	X
100% Electrical Verification	KEMET Standard	X	X	X
Read and Record Attributes/Variables Data	KEMET Standard			X
100% Surge Current, Option A or B with 5% PDA Calculation	MIL-PRF-55365 with 5% PDA Calculation	X	X	X
100% Electrical Verification	KEMET Standard	X	X	X
Read and Record Attributes/Variables Data	KEMET Standard			X
3 Sigma Screening – All Electricals	KEMET Standard	X	X	X
Read and Record Attributes/Variables Data	KEMET Standard			X
Destructive Physical Analysis (DPA) (5 pieces- each lot)	MIL-PRF-55365	X	X	X
Group B Testing (22 pieces – each lot)	* See Note Below		X	X
Temperature Stability – sample	MIL-PRF-55365	X	X	X
Solderability – Sample	MIL-PRF-55365	X	X	X
Group C Testing (57 pieces - each Lot)**	MIL-PRF-55365		X	X
100% X-ray	MIL-PRF-55365	X		
100% X-ray – 2 Plane***	MIL-PRF-55365 and KEMET Standard		X	X
100% Physical Dimension Verification	MIL-PRF-55365	X	X	X
Data Pack				
Group A and C Summaries			X	X
2 Plane X-ray JPEG photos			X	X
DPA Report			X	X
Attributes/Variables Data for Cap/Df/DCL/ESR				X

X = Included in test option

* Group B Testing = 10,000 Cycles Surge Current, 85°C, 40% Vr

** Group C Post Moisture ESR limit = 1.25 initial limit

*** 2 Plane X-ray = Top and side views, molded case wall thickness minimum 0.005" on all sides, negative/positive termination attachment criteria per MIL-STD-1580

Electrical Characteristics

ESR vs. Frequency

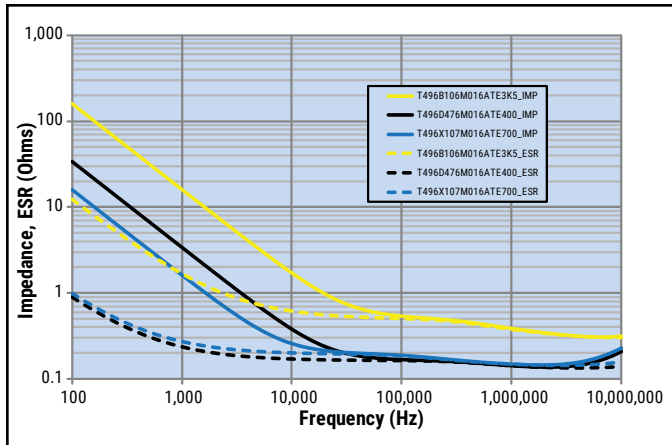

Capacitance vs. Frequency

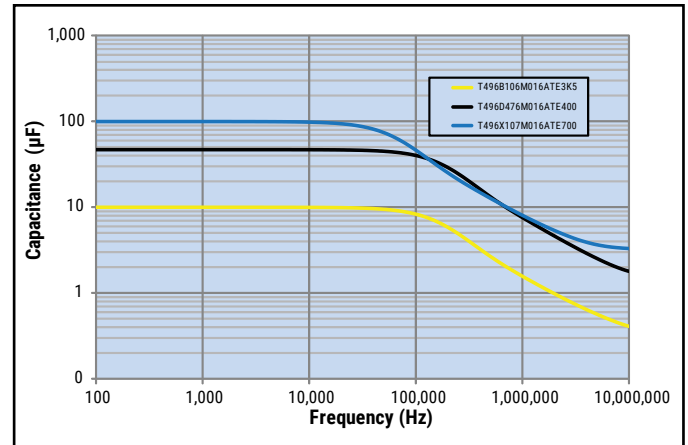

Dimensions – Millimeters (Inches)

Metric will govern

CATHODE (-) END VIEW

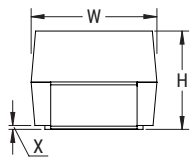

SIDE VIEW

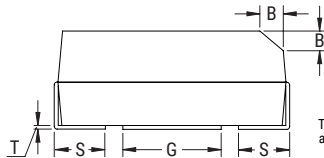

ANODE (+) END VIEW

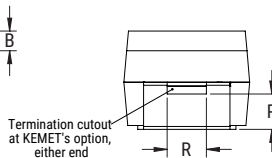

ANODE (+)/CATHODE (-) END VIEW B case Only

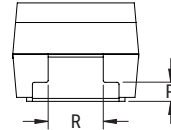

BOTTOM VIEW

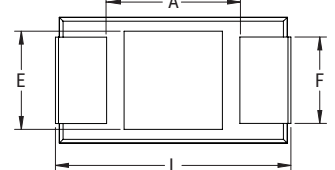

Case Size		Component													
KEMET	EIA	L	W	H	F±0.1 ±(0.004)	S±0.3 ±(0.012)	B±0.15 (Ref) ±0.006	X (Ref)	P (Ref)	R (Ref)	T (Ref)	A (Min)	G (Ref)	E (Ref)	Net Weight (mg)
B	3528-21	3.5±0.2 (0.138±0.008)	2.8±0.2 (0.110±0.008)	1.9±0.2 (0.075±0.008)	2.2 (0.087)	0.8 (0.031)	0.4 (0.016)	0.10±0.10 (0.004±0.004)	0.4 (0.016)	1.5 (0.059)	0.13 (0.005)	1.1 (0.043)	1.8 (0.071)	2.2 (0.087)	107.45
C	6032-28	6.0±0.3 (0.236±0.012)	3.2±0.3 (0.126±0.012)	2.5±0.3 (0.098±0.012)	2.2 (0.087)	1.3 (0.051)	0.5 (0.020)	0.10±0.10 (0.004±0.004)	0.9 (0.035)	1.0 (0.039)	0.13 (0.005)	2.5 (0.098)	2.8 (0.110)	2.4 (0.094)	224.48
D	7343-31	7.3±0.3 (0.287±0.012)	4.3±0.3 (0.169±0.012)	2.8±0.3 (0.110±0.012)	2.4 (0.094)	1.3 (0.051)	0.5 (0.020)	0.10±0.10 (0.004±0.004)	0.9 (0.035)	1.0 (0.039)	0.13 (0.005)	3.8 (0.150)	3.5 (0.138)	3.5 (0.138)	446.84
X	7343-43	7.3±0.3 (0.287±0.012)	4.3±0.3 (0.169±0.012)	4.0±0.3 (0.157±0.012)	2.4 (0.094)	1.3 (0.051)	0.5 (0.020)	0.10±0.10 (0.004±0.004)	1.7 (0.067)	1.0 (0.039)	0.13 (0.005)	3.8 (0.150)	3.5 (0.138)	3.5 (0.138)	652.04

Notes: (Ref) – Dimensions provided for reference only. No dimensions provided for B, P or R because low profile cases do not have a bevel or a notch. These weights are provided as a reference. If exact weights are needed, please contact your KEMET Sales Representative.

Table 1 – Ratings & Part Number Reference

Rated Voltage	Rated Capacitance	Case Code/ Case Size	KEMET Part Number	DC Leakage	DF	Standard ESR	Low ESR	Maximum Operating Temp	MSL
VDC @ 85°C	µF	KEMET/EIA	(See below for part options)	µA @ +20°C Maximum/5 Min	% @ +20°C 120 Hz Maximum	Ω @ +20°C 100 kHz Maximum	Ω @ +20°C 100 kHz Maximum	°C	Reflow Temp ≤ 260°C
4	68	C/6032-28	T496C686(1)004C(2)(3)(4)(5)	2.7	6	1.6	0.4	125	1
4	100	C/6032-28	T496C107(1)004C(2)(3)(4)(5)	4	8	1.2	N/A	125	1
4	150	C/6032-28	T496C157(1)004C(2)(3)(4)(5)	6	8	1.2	N/A	125	1
4	150	D/7343-31	T496D157(1)004C(2)(3)(4)(5)	6	8	0.8	N/A	125	1
4	220	D/7343-31	T496D227(1)004C(2)(3)(4)(5)	8.8	8	0.7	0.4	125	1
4	330	D/7343-31	T496D337(1)004C(2)(3)(4)(5)	13.2	8	0.7	0.4	125	1
4	330	X/7343-43	T496X337(1)004C(2)(3)(4)(5)	13.2	8	0.7	N/A	125	1
4	470	X/7343-43	T496X477(1)004C(2)(3)(4)(5)	18.8	8	0.5	N/A	125	1
6.3	4.7	B/3528-21	T496B475(1)006C(2)(3)(4)(5)	0.5	6	3.5	N/A	125	1
6.3	6.8	B/3528-21	T496B685(1)006C(2)(3)(4)(5)	0.5	6	3.5	N/A	125	1
6.3	10	B/3528-21	T496B106(1)006C(2)(3)(4)(5)	0.6	6	3.5	N/A	125	1
6.3	22	B/3528-21	T496B226(1)006C(2)(3)(4)(5)	1.3	6	3.5	1.5	125	1
6.3	15	C/6032-28	T496C156(1)006C(2)(3)(4)(5)	0.9	6	2	N/A	125	1
6.3	22	C/6032-28	T496C226(1)006C(2)(3)(4)(5)	1.4	6	2	N/A	125	1
6.3	33	C/6032-28	T496C336(1)006C(2)(3)(4)(5)	2	6	2	0.6	125	1
6.3	47	C/6032-28	T496C476(1)006C(2)(3)(4)(5)	2.9	6	1.6	0.6	125	1
6.3	47	D/7343-31	T496D476(1)006C(2)(3)(4)(5)	2.9	6	1	N/A	125	1
6.3	68	C/6032-28	T496C686(1)006C(2)(3)(4)(5)	4.1	6	1.2	N/A	125	1
6.3	68	D/7343-31	T496D686(1)006C(2)(3)(4)(5)	4.1	6	1	N/A	125	1
6.3	100	C/6032-28	T496C107(1)006C(2)(3)(4)(5)	6	8	0.4	N/A	125	1
6.3	100	D/7343-31	T496D107(1)006C(2)(3)(4)(5)	6	8	0.8	0.4	125	1
6.3	100	X/7343-43	T496X107(1)006C(2)(3)(4)(5)	6	8	0.9	0.3	125	1
6.3	150	D/7343-31	T496D157(1)006C(2)(3)(4)(5)	9	8	0.7	0.3	125	1
6.3	150	X/7343-43	T496X157(1)006C(2)(3)(4)(5)	9	8	0.3	N/A	125	1
6.3	220	X/7343-43	T496X227(1)006C(2)(3)(4)(5)	13.2	8	0.7	0.3	125	1
6.3	220	D/7343-31	T496D227(1)006C(2)(3)(4)(5)	13.2	8	0.7	0.3	125	1
6.3	330	X/7343-43	T496X337(1)006C(2)(3)(4)(5)	19.8	8	0.5	0.3	125	1
10	3.3	B/3528-21	T496B335(1)010C(2)(3)(4)(5)	0.5	6	3.5	N/A	125	1
10	4.7	B/3528-21	T496B475(1)010C(2)(3)(4)(5)	0.5	6	3.5	N/A	125	1
10	6.8	B/3528-21	T496B685(1)010C(2)(3)(4)(5)	0.7	6	3.5	N/A	125	1
10	10	C/6032-28	T496C106(1)010C(2)(3)(4)(5)	1	6	2	N/A	125	1
10	15	B/3528-21	T496B156(1)010C(2)(3)(4)(5)	1.5	6	3.5	N/A	125	1
10	15	C/6032-28	T496C156(1)010C(2)(3)(4)(5)	1.5	6	2	0.6	125	1
10	22	C/6032-28	T496C226(1)010C(2)(3)(4)(5)	2.2	6	2	0.5	125	1
10	33	C/6032-28	T496C336(1)010C(2)(3)(4)(5)	3.3	6	1.6	0.4	125	1
10	33	D/7343-31	T496D336(1)010C(2)(3)(4)(5)	3.3	6	1	0.4	125	1
10	47	C/6032-28	T496C476(1)010C(2)(3)(4)(5)	4.7	6	1.2	0.4	125	1
10	47	D/7343-31	T496D476(1)010C(2)(3)(4)(5)	4.7	6	1	0.4	125	1
10	68	D/7343-31	T496D686(1)010C(2)(3)(4)(5)	6.8	6	0.8	0.4	125	1
10	68	X/7343-43	T496X686(1)010C(2)(3)(4)(5)	6.8	6	0.9	N/A	125	1
10	100	D/7343-31	T496D107(1)010C(2)(3)(4)(5)	10	8	0.7	0.4	125	1
10	100	X/7343-43	T496X107(1)010C(2)(3)(4)(5)	10	8	0.4	N/A	125	1
10	150	D/7343-31	T496D157(1)010C(2)(3)(4)(5)	15	8	0.7	0.4	125	1
10	150	X/7343-43	T496X157(1)010C(2)(3)(4)(5)	15	8	0.7	0.4	125	1
VDC @ 85°C	µF	KEMET/EIA	(See below for part options)	µA @ +20°C Maximum/5 Min	% @ +20°C 120 Hz Maximum	Ω @ +20°C 100 kHz Maximum	Ω @ +20°C 100 kHz Maximum	°C	Reflow Temp ≤ 260°C
Rated Voltage	Rated Capacitance	Case Code/ Case Size	KEMET Part Number	DC Leakage	DF	Standard ESR	Low ESR	Maximum Operating Temp	MSL

(1) To complete KEMET part number, insert M for ± 20%, K for ± 10%. Designates Capacitance tolerance.
 (2) To complete KEMET part number, insert C = Hot Solder Dipped or H = Solder Plated. Designates Termination Finish.
 (3) To complete KEMET part number, insert 62 = 10 cycles +25°C, 63 = 10 cycles -55°C +85°C after Weibull, 64 = 10 cycles -55°C +85°C before Weibull or 65 = Both. Designates Surge Current option.
 (4) To complete KEMET part number, insert 1 = Standard ESR, 2 = Low ESR. Designates ESR option.
 (5) To complete KEMET part number, insert A = Option 1, B = Option 2 or C = Option 3. Designates Test Option. See Space Grade Test Methods chart for more information.
 Refer to Ordering Information for additional detail.

Table 1 – Ratings & Part Number Reference cont.

Rated Voltage	Rated Capacitance	Case Code/ Case Size	KEMET Part Number	DC Leakage	DF	Standard ESR	Low ESR	Maximum Operating Temp	MSL
VDC @ 85°C	µF	KEMET/EIA	(See below for part options)	µA @ +20°C Maximum/5 Min	% @ +20°C 120 Hz Maximum	Ω @ +20°C 100 kHz Maximum	Ω @ +20°C 100 kHz Maximum	°C	Reflow Temp ≤ 260°C
10	220	X/7343-43	T496X227(1)010C(2)(3)(4)(5)	22	8	0.5	0.3	125	1
16	2.2	B/3528-21	T496B225(1)016C(2)(3)(4)(5)	0.5	6	3.5	3.5	125	1
16	3.3	B/3528-21	T496B335(1)016C(2)(3)(4)(5)	0.5	6	3.5	2.1	125	1
16	4.7	B/3528-21	T496B475(1)016C(2)(3)(4)(5)	0.8	6	3.5	1.6	125	1
16	6.8	C/6032-28	T496C685(1)016C(2)(3)(4)(5)	1.1	6	2	0.6	125	1
16	10	C/6032-28	T496C106(1)016C(2)(3)(4)(5)	1.6	6	2	0.7	125	1
16	15	C/6032-28	T496C156(1)016C(2)(3)(4)(5)	2.4	6	2	0.6	125	1
16	22	C/6032-28	T496C226(1)016C(2)(3)(4)(5)	3.6	6	1.6	1	125	1
16	22	D/7343-31	T496D226(1)016C(2)(3)(4)(5)	3.6	6	1	0.5	125	1
16	33	D/7343-31	T496D336(1)016C(2)(3)(4)(5)	5.3	6	1	0.4	125	1
16	47	D/7343-31	T496D476(1)016C(2)(3)(4)(5)	7.5	6	0.8	0.4	125	1
16	47	X/7343-43	T496X476(1)016C(2)(3)(4)(5)	7.5	6	0.9	0.4	125	1
16	68	D/7343-31	T496D686(1)016C(2)(3)(4)(5)	10.9	8	0.4	N/A	125	1
20	1.5	B/3528-21	T496B155(1)020C(2)(3)(4)(5)	0.5	6	5	N/A	125	1
20	2.2	B/3528-21	T496B225(1)020C(2)(3)(4)(5)	0.5	6	3.5	1.6	125	1
20	4.7	C/6032-28	T496C475(1)020C(2)(3)(4)(5)	1	6	2	N/A	125	1
20	6.8	C/6032-28	T496C685(1)020C(2)(3)(4)(5)	1.4	6	2	0.6	125	1
20	10	C/6032-28	T496C106(1)020C(2)(3)(4)(5)	2	6	2	0.8	125	1
20	15	C/6032-28	T496C156(1)020C(2)(3)(4)(5)	3	6	0.5	N/A	125	1
20	15	D/7343-31	T496D156(1)020C(2)(3)(4)(5)	3	6	1	0.5	125	1
20	22	D/7343-31	T496D226(1)020C(2)(3)(4)(5)	4.4	6	1	0.5	125	1
20	33	D/7343-31	T496D336(1)020C(2)(3)(4)(5)	6.6	6	0.4	0.4	125	1
20	33	X/7343-43	T496X336(1)020C(2)(3)(4)(5)	6.6	6	0.9	0.4	125	1
25	0.68	B/3528-21	T496B684(1)025C(2)(3)(4)(5)	0.5	4	6.5	N/A	125	1
25	1	B/3528-21	T496B105(1)025C(2)(3)(4)(5)	0.5	4	5	3.5	125	1
25	1.5	B/3528-21	T496B155(1)025C(2)(3)(4)(5)	0.5	6	5	1.6	125	1
25	2.2	C/6032-28	T496C225(1)025C(2)(3)(4)(5)	0.6	6	3.5	N/A	125	1
25	3.3	C/6032-28	T496C335(1)025C(2)(3)(4)(5)	0.9	6	2.5	2.1	125	1
25	4.7	B/3528-21	T496B475(1)025C(2)(3)(4)(5)	1.2	6	4	N/A	125	1
25	4.7	C/6032-28	T496C475(1)025C(2)(3)(4)(5)	1.2	6	2.5	1.3	125	1
25	6.8	C/6032-28	T496C685(1)025C(2)(3)(4)(5)	1.7	6	2	0.6	125	1
25	10	D/7343-31	T496D106(1)025C(2)(3)(4)(5)	2.5	6	1.2	0.6	125	1
25	15	C/6032-28	T496C156(1)025C(2)(3)(4)(5)	3.8	6	0.75	N/A	125	1
25	15	D/7343-31	T496D156(1)025C(2)(3)(4)(5)	3.8	6	1	0.5	125	1
25	22	D/7343-31	T496D226(1)025C(2)(3)(4)(5)	5.5	6	0.8	0.4	125	1
25	22	X/7343-43	T496X226(1)025C(2)(3)(4)(5)	5.5	6	0.9	0.4	125	1
35	0.47	B/3528-21	T496B474(1)035C(2)(3)(4)(5)	0.5	4	8	2.6	125	1
35	0.68	B/3528-21	T496B684(1)035C(2)(3)(4)(5)	0.5	4	6.5	N/A	125	1
35	1	B/3528-21	T496B105(1)035C(2)(3)(4)(5)	0.5	4	5	3.1	125	1
35	1.5	C/6032-28	T496C155(1)035C(2)(3)(4)(5)	0.5	6	4.5	2.6	125	1
35	2.2	C/6032-28	T496C225(1)035C(2)(3)(4)(5)	0.8	6	3.5	1.6	125	1
35	3.3	C/6032-28	T496C335(1)035C(2)(3)(4)(5)	1.2	6	2.5	0.9	125	1
35	4.7	D/7343-31	T496D475(1)035C(2)(3)(4)(5)	1.7	6	1.5	0.7	125	1
VDC @ 85°C	µF	KEMET/EIA	(See below for part options)	µA @ +20°C Maximum/5 Min	% @ +20°C 120 Hz Maximum	Ω @ +20°C 100 kHz Maximum	Ω @ +20°C 100 kHz Maximum	°C	Reflow Temp ≤ 260°C
Rated Voltage	Rated Capacitance	Case Code/ Case Size	KEMET Part Number	DC Leakage	DF	Standard ESR	Low ESR	Maximum Operating Temp	MSL

- (1) To complete KEMET part number, insert M for ± 20%, K for ± 10%. Designates Capacitance tolerance.
 (2) To complete KEMET part number, insert C= Hot Solder Dipped or H = Solder Plated. Designates Termination Finish.
 (3) To complete KEMET part number, insert 62 = 10 cycles +25°C, 63 = 10 cycles -55°C +85°C after Weibull, 64 = 10 cycles -55°C +85°C before Weibull or 65 = Both. Designates Surge Current option.
 (4) To complete KEMET part number, insert 1 = Standard ESR, 2 = Low ESR. Designates ESR option.
 (5) To complete KEMET part number, insert A = Option 1, B = Option 2 or C = Option 3. Designates Test Option. See Space Grade Test Methods chart for more information.
 Refer to Ordering Information for additional detail.

Table 1 – Ratings & Part Number Reference cont.

Rated Voltage	Rated Capacitance	Case Code/ Case Size	KEMET Part Number	DC Leakage	DF	Standard ESR	Low ESR	Maximum Operating Temp	MSL
VDC @ 85°C	µF	KEMET/EIA	(See below for part options)	µA @ +20°C Maximum/5 Min	% @ +20°C 120 Hz Maximum	Ω @ +20°C 100 kHz Maximum	Ω @ +20°C 100 kHz Maximum	°C	Reflow Temp ≤ 260°C
35	6.8	D/7343-31	T496D685(1)035C(2)(3)(4)(5)	2.4	6	1.3	0.75	125	1
35	10	D/7343-31	T496D106(1)035C(2)(3)(4)(5)	3.5	6	0.5	N/A	125	1
35	10	X/7343-43	T496X106(1)035C(2)(3)(4)(5)	3.5	6	1	0.5	125	1
35	15	D/7343-31	T496D156(1)035C(2)(3)(4)(5)	5.3	6	0.5	N/A	125	1
35	15	X/7343-43	T496X156(1)035C(2)(3)(4)(5)	5.3	6	0.9	0.9	125	1
50	0.15	B/3528-21	T496B154(1)050C(2)(3)(4)(5)	0.5	4	16	N/A	125	1
50	0.22	B/3528-21	T496B224(1)050C(2)(3)(4)(5)	0.5	4	14	10	125	1
50	0.33	B/3528-21	T496B334(1)050C(2)(3)(4)(5)	0.5	4	10	2.6	125	1
50	0.47	C/6032-28	T496C474(1)050C(2)(3)(4)(5)	0.5	4	8	1.9	125	1
50	0.68	C/6032-28	T496C684(1)050C(2)(3)(4)(5)	0.5	4	7	1.7	125	1
50	1	C/6032-28	T496C105(1)050C(2)(3)(4)(5)	0.5	4	5.5	2.7	125	1
50	1.5	C/6032-28	T496C155(1)050C(2)(3)(4)(5)	0.8	6	5	2	125	1
50	2.2	D/7343-31	T496D225(1)050C(2)(3)(4)(5)	1.1	6	2.5	0.9	125	1
50	3.3	D/7343-31	T496D335(1)050C(2)(3)(4)(5)	1.7	6	2	1	125	1
50	4.7	D/7343-31	T496D475(1)050C(2)(3)(4)(5)	2.4	6	0.4	N/A	125	1
50	4.7	X/7343-43	T496X475(1)050C(2)(3)(4)(5)	2.4	6	1.5	0.4	125	1
VDC @ 85°C	µF	KEMET/EIA	(See below for part options)	µA @ +20°C Maximum/5 Min	% @ +20°C 120 Hz Maximum	Ω @ +20°C 100 kHz Maximum	Ω @ +20°C 100 kHz Maximum	°C	Reflow Temp ≤ 260°C
Rated Voltage	Rated Capacitance	Case Code/ Case Size	KEMET Part Number	DC Leakage	DF	Standard ESR	Low ESR	Maximum Operating Temp	MSL

- (1) To complete KEMET part number, insert M for ± 20%, K for ± 10%. Designates Capacitance tolerance.
(2) To complete KEMET part number, insert C= Hot Solder Dipped or H = Solder Plated. Designates Termination Finish.
(3) To complete KEMET part number, insert 62 = 10 cycles +25°C, 63 = 10 cycles -55°C +85°C after Weibull, 64 = 10 cycles -55°C +85°C before Weibull or 65 = Both. Designates Surge Current option.
(4) To complete KEMET part number, insert 1 = Standard ESR, 2 = Low ESR. Designates ESR option.
(5) To complete KEMET part number, insert A = Option 1, B = Option 2 or C = Option 3. Designates Test Option. See Space Grade Test Methods chart for more information.
Refer to Ordering Information for additional detail.

Recommended Voltage Derating Guidelines

	-55°C to 85°C	85°C to 125°C
% Change in Working DC Voltage with Temperature	V _R	67% of V _R
Recommended Maximum Application Voltage	50% of V _R	33% of V _R

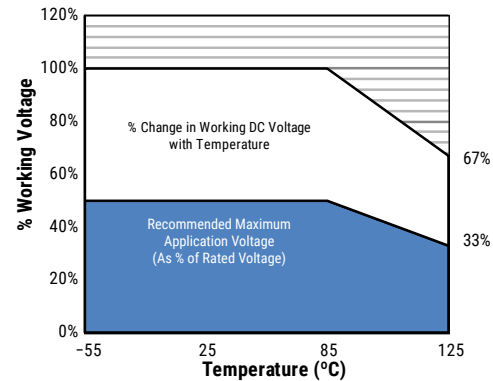

Ripple Current/Ripple Voltage

Permissible AC ripple voltage and current are related to equivalent series resistance (ESR) and the power dissipation capabilities of the device. Permissible AC ripple voltage which may be applied is limited by two criteria:

1. The positive peak AC voltage plus the DC bias voltage, if any, must not exceed the DC voltage rating of the capacitor.
2. The negative peak AC voltage in combination with bias voltage, if any, must not exceed the allowable limits specified for reverse voltage. See the Reverse Voltage section for allowable limits.

The maximum power dissipation by case size can be determined using the table at right. The maximum power dissipation rating stated in the table must be reduced with increasing environmental operating temperatures. Refer to the table below for temperature compensation requirements.

KEMET Case Code	EIA Case Code	Maximum Power Dissipation (P _{max}) mWatts at 25°C with +20°C Rise
B	3528-21	85
C	6032-28	110
D	7343-31	150
X	7343-43	165

Using the P_{max} of the device, the maximum allowable rms ripple current or voltage may be determined.

$$I(max) = \sqrt{P_{max}/R}$$

$$E(max) = Z \sqrt{P_{max}/R}$$

I = rms ripple current (amperes)

E = rms ripple voltage (volts)

P_{max} = maximum power dissipation (watts)

R = ESR at specified frequency (ohms)

Z = Impedance at specified frequency (ohms)

Temperature Compensation Multipliers for Maximum Ripple Current		
T ≤ 25°C	T ≤ 85°C	T ≤ 125°C
1.00	0.90	0.40

T = Environmental Temperature

The maximum power dissipation rating must be reduced with increasing environmental operating temperatures. Refer to the Temperature Compensation Multiplier table for details.

Reverse Voltage

Solid tantalum capacitors are polar devices and may be permanently damaged or destroyed if connected with the wrong polarity. The positive terminal is identified on the capacitor body by a stripe plus in some cases a beveled edge. A small degree of transient reverse voltage is permissible for short periods per the table. The capacitors should not be operated continuously in reverse mode, even within these limits.

Temperature	Permissible Transient Reverse Voltage
25°C	15% of Rated Voltage
85°C	5% of Rated Voltage
125°C	1% of Rated Voltage

Table 2 – Land Dimensions/Courtyard

KEMET	Metric Size Code	Density Level A: Maximum (Most) Land Protrusion (mm)					Density Level B: Median (Nominal) Land Protrusion (mm)					Density Level C: Minimum (Least) Land Protrusion (mm)				
		W	L	S	V1	V2	W	L	S	V1	V2	W	L	S	V1	V2
B	3528-21	2.35	2.21	0.92	6.32	4.00	2.23	1.80	1.12	5.22	3.50	2.13	1.42	1.28	4.36	3.24
C	6032-28	2.35	2.77	2.37	8.92	4.50	2.23	2.37	2.57	7.82	4.00	2.13	1.99	2.73	6.96	3.74
D	7343-31	2.55	2.77	3.67	10.22	5.60	2.43	2.37	3.87	9.12	5.10	2.33	1.99	4.03	8.26	4.84
X ¹	7343-43	2.55	2.77	3.67	10.22	5.60	2.43	2.37	3.87	9.12	5.10	2.33	1.99	4.03	8.26	4.84

Density Level A: For low-density product applications. Recommended for wave solder applications and provides a wider process window for reflow solder processes.

Density Level B: For products with a moderate level of component density. Provides a robust solder attachment condition for reflow solder processes.

Density Level C: For high component density product applications. Before adapting the minimum land pattern variations the user should perform qualification testing based on the conditions outlined in IPC Standard 7351 (IPC-7351).

¹ Height of these chips may create problems in wave soldering.

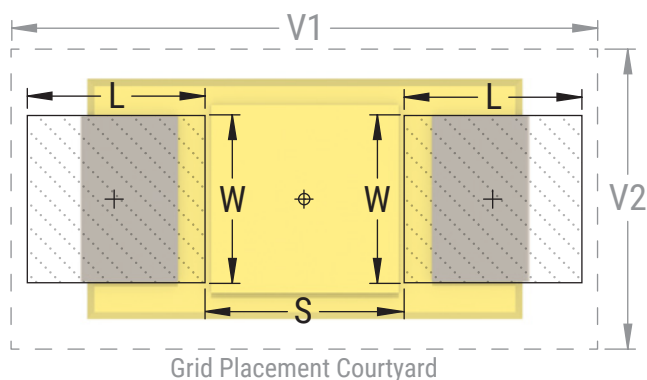

Soldering Process

KEMET’s families of surface mount capacitors are compatible with wave (single or dual), convection, IR, or vapor phase reflow techniques. Preheating of these components is recommended to avoid extreme thermal stress. KEMET’s recommended profile conditions for convection and IR reflow reflect the profile conditions of the IPC/J–STD–020D standard for moisture sensitivity testing. The devices can safely withstand a maximum of three reflow passes at these conditions.

Please note that although the X/7343–43 case size can withstand wave soldering, the tall profile (4.3 mm maximum) dictates care in wave process development.

Hand soldering should be performed with care due to the difficulty in process control. If performed, care should be taken to avoid contact of the soldering iron to the molded case. The iron should be used to heat the solder pad, applying solder between the pad and the termination, until reflow occurs. Once reflow occurs, the iron should be removed immediately. “Wiping” the edges of a chip and heating the top surface is not recommended.

During typical reflow operations, a slight darkening of the gold-colored epoxy may be observed. This slight darkening is normal and not harmful to the product. Marking permanency is not affected by this change.

Profile Feature	SnPb Assembly	Pb-Free Assembly
Preheat/Soak		
Temperature Minimum (T_{smin})	100°C	150°C
Temperature Maximum (T_{smax})	150°C	200°C
Time (t_s) from T_{smin} to T_{smax}	60 – 120 seconds	60 – 120 seconds
Ramp-up Rate (T_L to T_P)	3°C/seconds maximum	3°C/seconds maximum
Liquidous Temperature (T_L)	183°C	217°C
Time Above Liquidous (t_L)	60 – 150 seconds	60 – 150 seconds
Peak Temperature (T_P)	220°C* 235°C**	250°C* 260°C**
Time within 5°C of Maximum Peak Temperature (t_p)	20 seconds maximum	30 seconds maximum
Ramp-down Rate (T_P to T_L)	6°C/seconds maximum	6°C/seconds maximum
Time 25°C to Peak Temperature	6 minutes maximum	8 minutes maximum

Note: All temperatures refer to the center of the package, measured on the package body surface that is facing up during assembly reflow.

* For Case Size height > 2.5 mm

** For Case Size height ≤ 2.5 mm

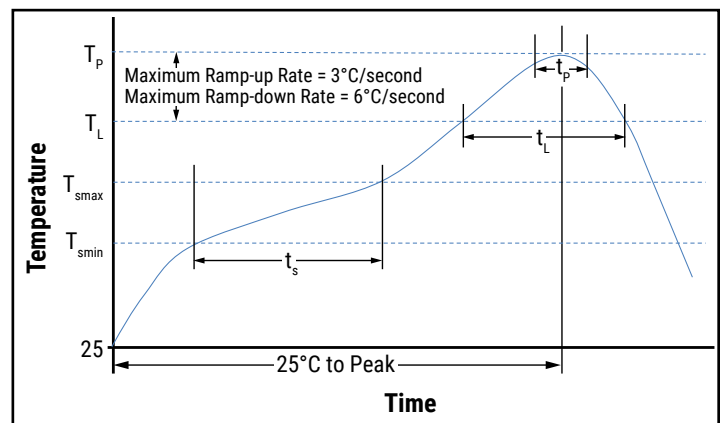

Storage

Tantalum chip capacitors should be stored in normal working environments. While the chips themselves are quite robust in other environments, solderability will be degraded by exposure to high temperatures, high humidity, corrosive atmospheres, and long term storage. In addition, packaging materials will be degraded by high temperature—reels may soften or warp and tape peel force may increase. KEMET recommends that maximum storage temperature not exceed 40°C and maximum storage humidity not exceed 60% relative humidity. Temperature fluctuations should be minimized to avoid condensation on the parts and atmospheres should be free of chlorine and sulphur bearing compounds. For optimized solderability chip stock should be used promptly, preferably within three years of receipt.

Construction

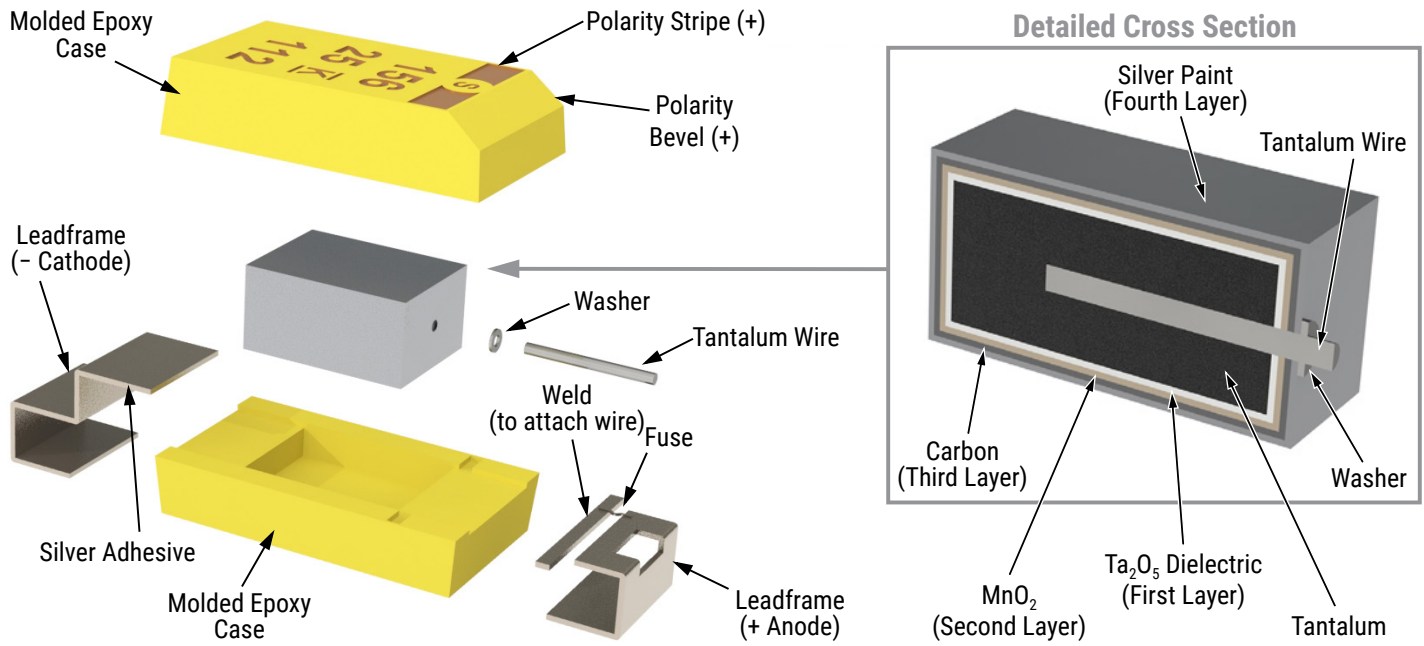

Capacitor Marking

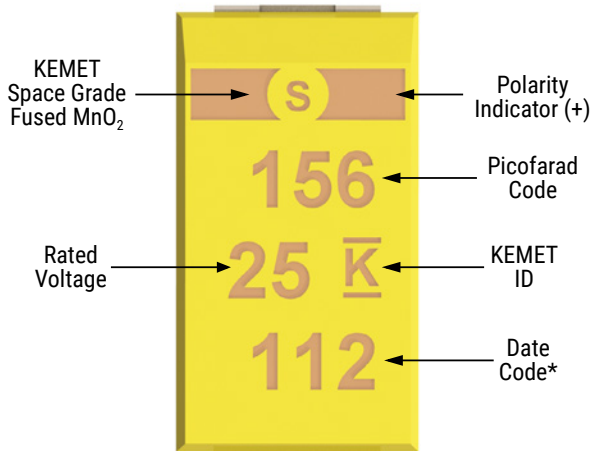

* 112 = 12th week of 2021

Date Code *	
1 st digit = Last number of Year	8 = 2018 9 = 2019 0 = 2020 1 = 2021
2 nd and 3 rd digit = Week of the Year	01 = 1 st week of the Year to 52 = 52 nd week of the Year

Parts screened with Option C are marked with a serial number below date code characters.

Tape & Reel Packaging Information

KEMET’s molded tantalum and aluminum chip capacitor families are packaged in 8 and 12 mm plastic tape on 7” and 13” reels in accordance with *EIA Standard 481: Embossed Carrier Taping of Surface Mount Components for Automatic Handling*. This packaging system is compatible with all tape-fed automatic pick-and-place systems.

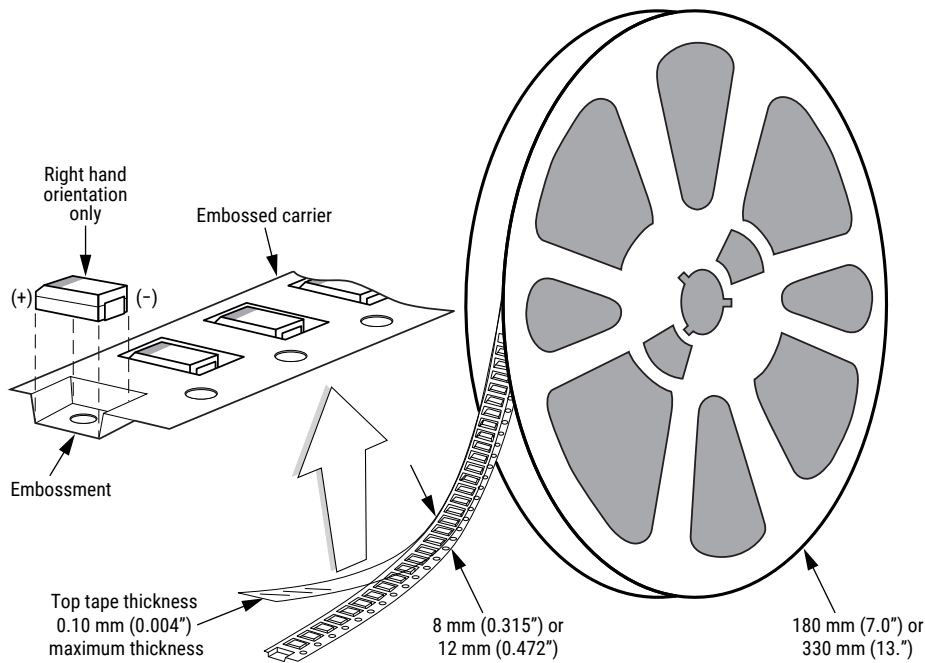

Table 3 – Packaging Quantity

Case Code		Tape Width (mm)	7" Reel*
KEMET	EIA		
B	3528-21	8	2,000
C	6032-28	12	500
D	7343-31	12	500
X	7343-43	12	500

Figure 1 – Embossed (Plastic) Carrier Tape Dimensions



Table 4 – Embossed (Plastic) Carrier Tape Dimensions

Metric will govern

Constant Dimensions – Millimeters (Inches)									
Tape Size	D ₀	D ₁ Minimum Note 1	E ₁	P ₀	P ₂	R Reference Note 2	S ₁ Minimum Note 3	T Maximum	T ₁ Maximum
8 mm	1.5 +0.10/-0.0 (0.059 +0.004/-0.0)	1.0 (0.039)	1.75 ±0.10 (0.069 ±0.004)	4.0 ±0.10 (0.157 ±0.004)	2.0 ±0.05 (0.079 ±0.002)	25.0 (0.984)	0.600 (0.024)	0.600 (0.024)	0.100 (0.004)
12 mm		1.5 (0.059)							

Variable Dimensions – Millimeters (Inches)									
Tape Size	Pitch	B ₁ Maximum Note 4	E ₂ Minimum	F	P ₁	T ₂ Maximum	W Maximum	A ₀ , B ₀ & K ₀	
8 mm	Single (4 mm)	4.35 (0.171)	6.25 (0.246)	3.5 ±0.05 (0.138 ±0.002)	2.0 ±0.05 or 4.0 ±0.10 (0.079 ±0.002 or 0.157 ±0.004)	2.5 (0.098)	8.3 (0.327)	Note 5	
12 mm	Single (4 mm) and Double (8 mm)	8.2 (0.323)	10.25 (0.404)	5.5 ±0.05 (0.217 ±0.002)	2.0 ±0.05 (0.079 ±0.002) or 4.0 ±0.10 (0.157 ±0.004) or 8.0 ±0.10 (0.315 ±0.004)	4.6 (0.181)	12.3 (0.484)		

1. The embossment hole location shall be measured from the sprocket hole controlling the location of the embossment. Dimensions of embossment location and hole location shall be applied independent of each other.
2. The tape, with or without components, shall pass around R without damage (see Figure 4).
3. If S₁ < 1.0 mm, there may not be enough area for cover tape to be properly applied (see EIA Standard 481-D, paragraph 4.3, section b).
4. B₁ dimension is a reference dimension for tape feeder clearance only.
5. The cavity defined by A₀, B₀ and K₀ shall surround the component with sufficient clearance that:
 - (a) the component does not protrude above the top surface of the carrier tape.
 - (b) the component can be removed from the cavity in a vertical direction without mechanical restriction, after the top cover tape has been removed.
 - (c) rotation of the component is limited to 20° maximum for 8 and 12 mm tapes (see Figure 2).
 - (d) lateral movement of the component is restricted to 0.5 mm maximum for 8 mm and 12 mm wide tape (see Figure 3).
 - (e) see Addendum in EIA Standard 481-D for standards relating to more precise taping requirements.

Packaging Information Performance Notes

- Cover tape break force:** 1.0 kg minimum.
- Cover tape peel strength:** The total peel strength of the cover tape from the carrier tape shall be:

Tape Width	Peel Strength
8 mm	0.1 to 1.0 newton (10 to 100 gf)
12 mm	0.1 to 1.3 newton (10 to 130 gf)

The direction of the pull shall be opposite the direction of the carrier tape travel. The pull angle of the carrier tape shall be 165° to 180° from the plane of the carrier tape. During peeling, the carrier and/or cover tape shall be pulled at a velocity of 300 ±10 mm/minute.

- Labeling:** Bar code labeling (standard or custom) shall be on the side of the reel opposite the sprocket holes. Refer to EIA Standards 556 and 624.

Figure 2 – Maximum Component Rotation

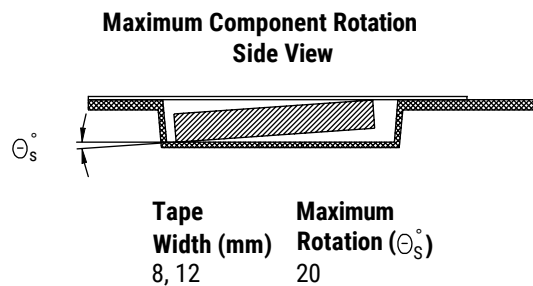
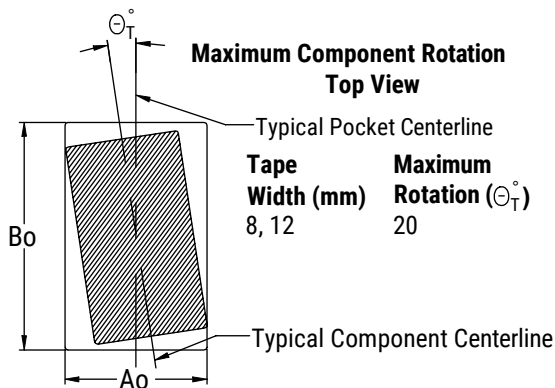

Figure 3 – Maximum Lateral Movement

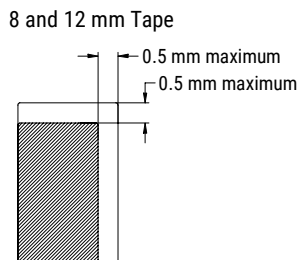

Figure 4 – Bending Radius

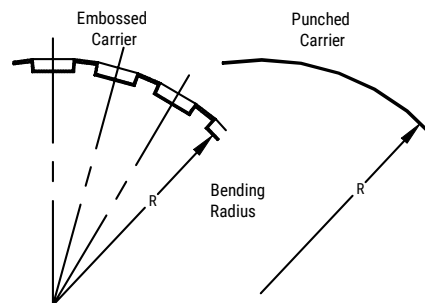
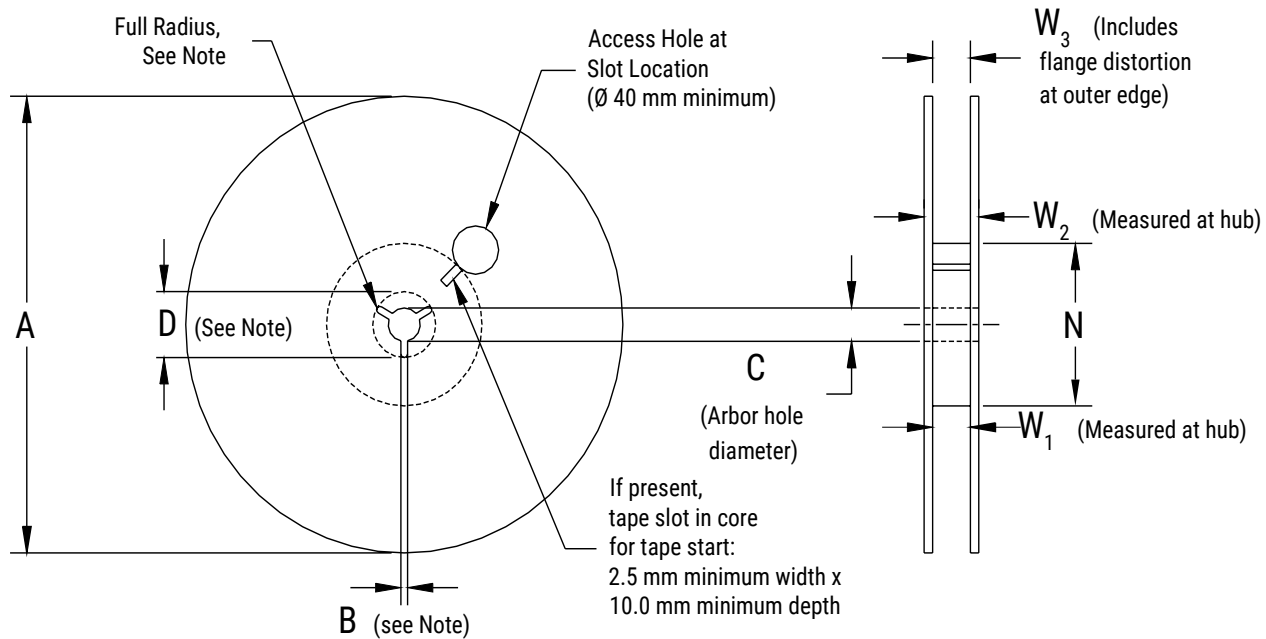

Figure 5 – Reel Dimensions



Note: Drive spokes optional; if used, dimensions B and D shall apply.

Table 5 – Reel Dimensions

Metric will govern

Constant Dimensions – Millimeters (Inches)				
Tape Size	A	B Minimum	C	D Minimum
8 mm	178 ±0.20 (7.008 ±0.008)	1.5 (0.059)	13.0 +0.5/-0.2 (0.521 +0.02/-0.008)	20.2 (0.795)
12 mm	330 ±0.20 (13.000 ±0.008)			
Variable Dimensions – Millimeters (Inches)				
Tape Size	N Minimum	W_1	W_2 Maximum	W_3
8 mm	50 (1.969)	8.4 +1.5/-0.0 (0.331 +0.059/-0.0)	14.4 (0.567)	Shall accommodate tape width without interference
12 mm		12.4 +2.0/-0.0 (0.488 +0.078/-0.0)	18.4 (0.724)	

Figure 6 – Tape Leader & Trailer Dimensions

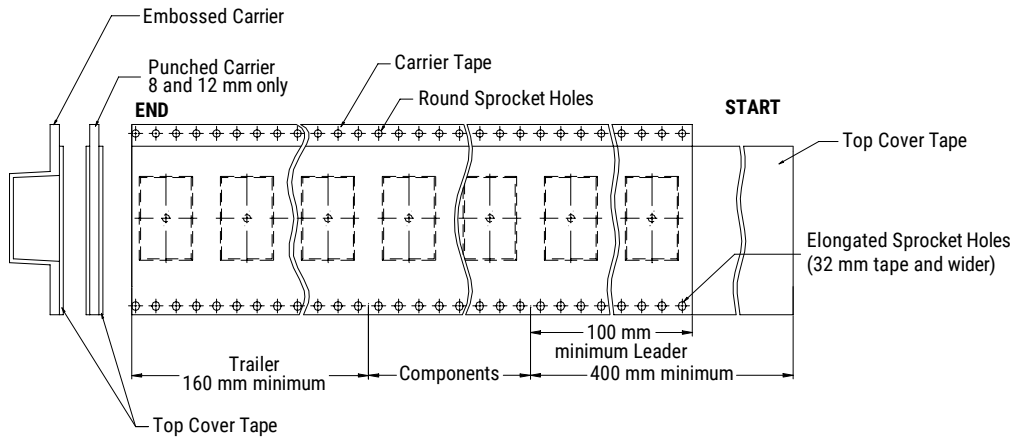
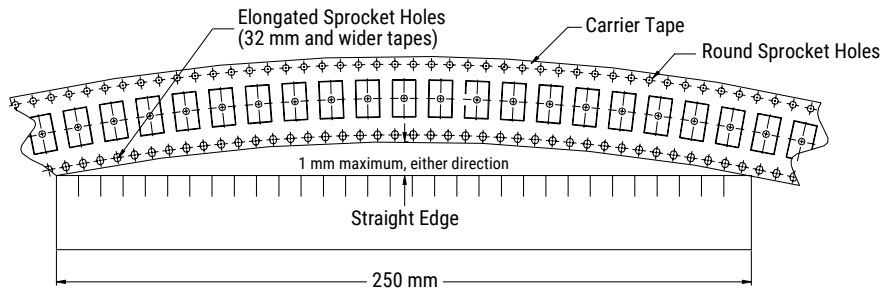

Figure 7 – Maximum Camber



KEMET Electronics Corporation Sales Offices

For a complete list of our global sales offices, please visit www.kemet.com/sales.

Disclaimer

All product specifications, statements, information and data (collectively, the "Information") in this datasheet are subject to change. The customer is responsible for checking and verifying the extent to which the Information contained in this publication is applicable to an order at the time the order is placed. All Information given herein is believed to be accurate and reliable, but it is presented without guarantee, warranty, or responsibility of any kind, expressed or implied.

Statements of suitability for certain applications are based on KEMET Electronics Corporation's ("KEMET") knowledge of typical operating conditions for such applications, but are not intended to constitute – and KEMET specifically disclaims – any warranty concerning suitability for a specific customer application or use. The Information is intended for use only by customers who have the requisite experience and capability to determine the correct products for their application. Any technical advice inferred from this Information or otherwise provided by KEMET with reference to the use of KEMET's products is given gratis, and KEMET assumes no obligation or liability for the advice given or results obtained.

Although KEMET designs and manufactures its products to the most stringent quality and safety standards, given the current state of the art, isolated component failures may still occur. Accordingly, customer applications which require a high degree of reliability or safety should employ suitable designs or other safeguards (such as installation of protective circuitry or redundancies) in order to ensure that the failure of an electrical component does not result in a risk of personal injury or property damage.

Although all product-related warnings, cautions and notes must be observed, the customer should not assume that all safety measures are indicated or that other measures may not be required.

KEMET is a registered trademark of KEMET Electronics Corporation.