

# NCP4586

## Voltage Regulator - Low Noise, Low Dropout

### 150 mA

The NCP4586 is a CMOS 150 mA low dropout linear with low noise, high ripple rejection, low dropout, high output voltage accuracy and low supply current. The device is available in three configurations: enable high, enable low and enable high plus auto-discharge. Small packages allow mounting on high density PCBs. This is an excellent general purpose regulator, well suited to many applications.

#### Features

- Operating Input Voltage Range: 1.7 V to 6.5 V
- Output Voltage Range: 1.2 to 5.0 V (available in 0.1 V steps)
- Very Low Dropout: 320 mV Typ. at 150 mA
- $\pm 1\%$  Output Voltage Accuracy ( $V_{OUT} > 2\text{ V}$ ,  $T_J = 25^\circ\text{C}$ )
- High PSRR: 80 dB at 1 kHz
- Current Fold Back Protection
- Stable with a 0.47  $\mu\text{F}$  Ceramic Capacitors
- Available in 1.0 x 1.0 UDFN, SC-82AB and SOT23-5 Package
- These are Pb-Free Devices

#### Typical Applications

- Battery Powered Equipment
- Portable Communication Equipment
- Cameras, MP3 Players and Camcorder
- High Stability Voltage Reference

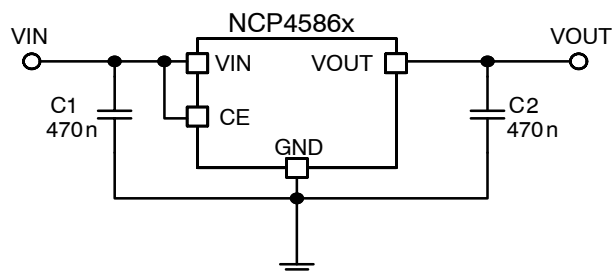

Figure 1. Typical Application Schematic



ON Semiconductor™

<http://onsemi.com>

#### MARKING DIAGRAMS

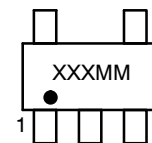
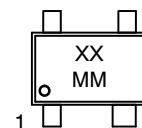

SOT-23-5  
CASE 1212

XX, XXX = Specific Product Code  
MM = Lot Number

#### ORDERING INFORMATION

See detailed ordering and shipping information in the package dimensions section on page 15 of this data sheet.

# NCP4586

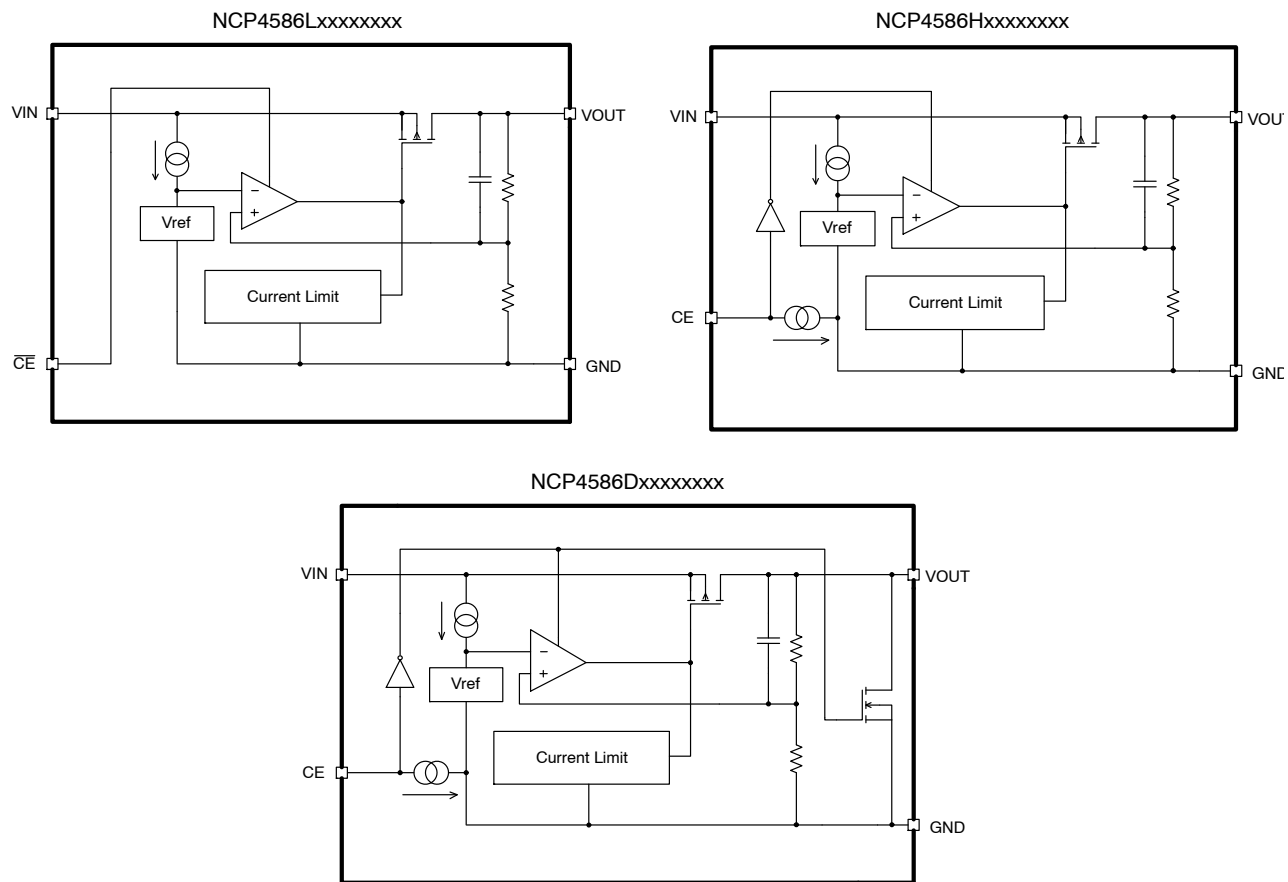

Figure 2. Simplified Schematic Block Diagram

## PIN FUNCTION DESCRIPTION

Pin No. UDFN4	Pin No. SC82-AB	Pin No. SOT23-5	Pin Name	Description
4	4	1	VIN	Input pin
2	2	2	GND	Ground
3	1	3	$\overline{\text{CE}}$ /CE	Chip enable pin ("L" active / "H" active)
1	3	5	VOUT	Output pin
-	-	4	NC	No connection

# NCP4586

## ABSOLUTE MAXIMUM RATINGS

Rating	Symbol	Value	Unit
Input Voltage (Note 1)	$V_{IN}$	7	V
Output Voltage	$V_{OUT}$	-0.3 to $V_{IN} + 0.3$	V
Chip Enable Input	$V_{CE}$	-0.3 to 7	V
Output Current	$I_{OUT}$	200	mA
Power Dissipation UDFN4	$P_D$	400	mW
Power Dissipation SC-82AB		380	
Power Dissipation SOT23-5		420	
Maximum Junction Temperature	$T_{J(MAX)}$	+150	°C
Operating Ambient Temperature	$T_A$	-40 to +85	°C
Storage Temperature	$T_{STG}$	-55 to +125	°C
ESD Capability, Human Body Model (Note 2)	$ESD_{HBM}$	2000	V
ESD Capability, Machine Model (Note 2)	$ESD_{MM}$	200	V

Stresses exceeding Maximum Ratings may damage the device. Maximum Ratings are stress ratings only. Functional operation above the Recommended Operating Conditions is not implied. Extended exposure to stresses above the Recommended Operating Conditions may affect device reliability.

1. Refer to ELECTRICAL CHARACTERISTICS and APPLICATION INFORMATION for Safe Operating Area.
2. This device series incorporates ESD protection and is tested by the following methods:  
 ESD Human Body Model tested per AEC-Q100-002 (EIA/JESD22-A114)  
 ESD Machine Model tested per AEC-Q100-003 (EIA/JESD22-A115)  
 Latchup Current Maximum Rating tested per JEDEC standard: JESD78.

## THERMAL CHARACTERISTICS

Rating	Symbol	Value	Unit
Thermal Characteristics, UDFN4 Thermal Resistance, Junction-to-Air	$R_{\theta JA}$	250	°C/W
Thermal Characteristics, SOT23-5 Thermal Resistance, Junction-to-Air	$R_{\theta JA}$	238	°C/W
Thermal Characteristics, SC 82AB Thermal Resistance, Junction-to-Air	$R_{\theta JA}$	263	°C/W

# NCP4586

**ELECTRICAL CHARACTERISTICS**  $-40^{\circ}\text{C} \leq T_A \leq 85^{\circ}\text{C}$ ;  $V_{\text{IN}} = V_{\text{OUT(NOM)}} + 1\text{ V}$  or  $2.5\text{ V}$ , whichever is greater;  $I_{\text{OUT}} = 1\text{ mA}$ ,  $C_{\text{IN}} = C_{\text{OUT}} = 0.47\text{ }\mu\text{F}$ , unless otherwise noted. Typical values are at  $T_A = +25^{\circ}\text{C}$ .

Parameter	Test Conditions		Symbol	Min	Typ	Max	Unit
Operating Input Voltage			$V_{\text{IN}}$	1.7		6.5	V
Output Voltage	$T_A = +25^{\circ}\text{C}$	$V_{\text{OUT}} > 2\text{ V}$	$V_{\text{OUT}}$	x0.99		x1.01	V
		$V_{\text{OUT}} \leq 2\text{ V}$		-20		20	mV
	$-40^{\circ}\text{C} \leq T_A \leq 85^{\circ}\text{C}$	$V_{\text{OUT}} > 2\text{ V}$		x0.985		x1.015	V
		$V_{\text{OUT}} \leq 2\text{ V}$		-30		30	mV
Output Voltage Temp. Coefficient	$T_A = -40\text{ to }85^{\circ}\text{C}$				$\pm 20$		ppm/ $^{\circ}\text{C}$
Line Regulation	$V_{\text{IN}} = V_{\text{OUT}} + 0.5\text{ V to }5\text{ V}$		$\text{LineReg}$		0.02	0.10	%/V
Load Regulation	$I_{\text{OUT}} = 1\text{ mA to }150\text{ mA}$		$\text{LoadReg}$		10	30	mV
Dropout Voltage	$I_{\text{OUT}} = 150\text{ mA}$	$1.2\text{ V} \leq V_{\text{OUT}} < 1.5\text{ V}$	$V_{\text{DO}}$		0.67	1.00	V
		$1.5\text{ V} \leq V_{\text{OUT}} < 1.7\text{ V}$			0.54	0.81	
		$1.7\text{ V} \leq V_{\text{OUT}} < 2.0\text{ V}$			0.46	0.68	
		$2.0\text{ V} \leq V_{\text{OUT}} < 2.5\text{ V}$			0.41	0.60	
		$2.5\text{ V} \leq V_{\text{OUT}} < 4.0\text{ V}$			0.32	0.51	
		$4.0\text{ V} \leq V_{\text{OUT}}$			0.24	0.37	
Output Current			$I_{\text{OUT}}$	150			mA
Short Current Limit	$V_{\text{OUT}} = 0\text{ V}$		$I_{\text{SC}}$		40		mA
Quiescent Current	$I_{\text{OUT}} = 0\text{ mA}$		$I_{\text{Q}}$		38	58	$\mu\text{A}$
Standby Current	$V_{\text{CE}} = V_{\text{IN}}$ (L version), $V_{\text{CE}} = 0\text{ V}$ (H and D version), $T_A = 25^{\circ}\text{C}$		$I_{\text{STB}}$		0.1	1	$\mu\text{A}$
$\overline{\text{CE}}/\text{CE}$ Pin Threshold Voltage	$\overline{\text{CE}} / \text{CE}$ Input Voltage "H"		$V_{\text{CEH}}$	1.0			V
	$\overline{\text{CE}} / \text{CE}$ Input Voltage "L"		$V_{\text{CEL}}$			0.4	
CE Pull Down Current	H and D version		$I_{\text{PD}}$		0.4		$\mu\text{A}$
Power Supply Rejection Ratio	$V_{\text{IN}} = V_{\text{OUT}} + 1\text{ V}$ or $3.0\text{ V}$ whichever is higher, $I_{\text{OUT}} = 30\text{ mA}$ , $f = 1\text{ kHz}$		PSRR		80		dB
Output Noise Voltage	$V_{\text{OUT}} = 1.2\text{ V}$ , $I_{\text{OUT}} = 30\text{ mA}$ , $f = 10\text{ Hz to }100\text{ kHz}$		$V_{\text{N}}$		30		$\mu\text{V}_{\text{rms}}$
Low Output N-ch Tr. On Resistance	D Version only, $V_{\text{IN}} = 4\text{ V}$ , $V_{\text{CE}} = 0\text{ V}$		$R_{\text{LOW}}$		30		$\Omega$

TYPICAL CHARACTERISTICS

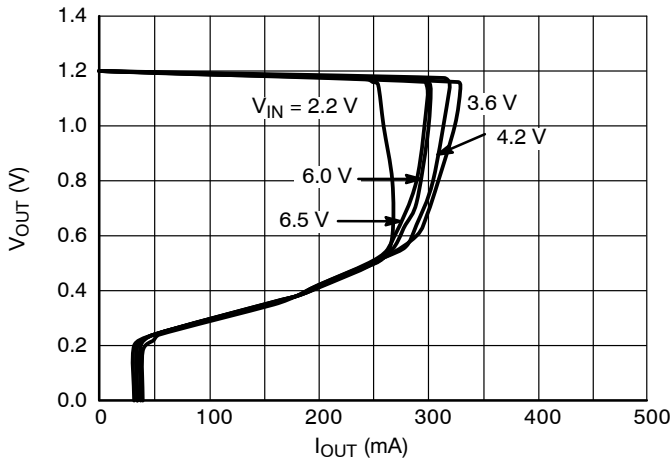

Figure 3. Output Voltage vs. Output Current  
1.2 V Version ( $T_A = 25^\circ\text{C}$ )

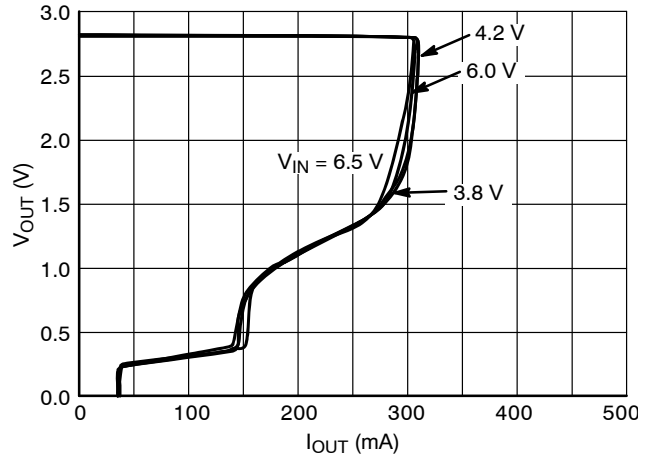

Figure 4. Output Voltage vs. Output Current  
2.8 V Version ( $T_A = 25^\circ\text{C}$ )

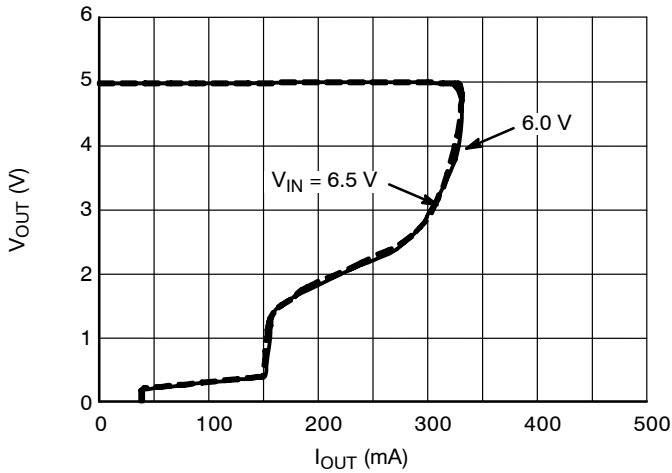

Figure 5. Output Voltage vs. Output Current  
5.0 V version ( $T_A = 25^\circ\text{C}$ )

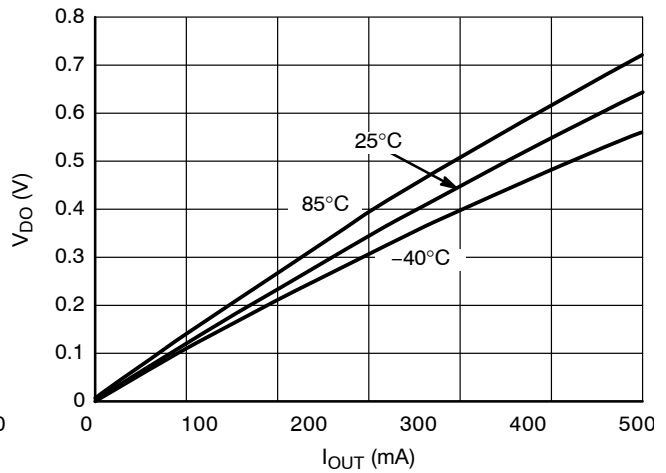

Figure 6. Dropout Voltage vs. Output Current  
1.2 V version

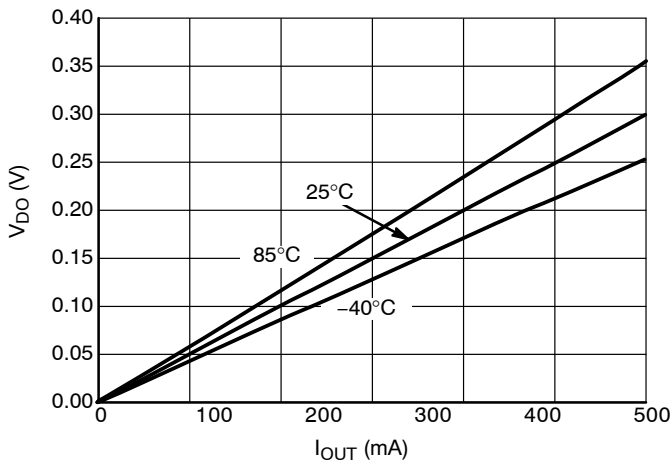

Figure 7. Dropout Voltage vs. Output Current  
2.8 V Version

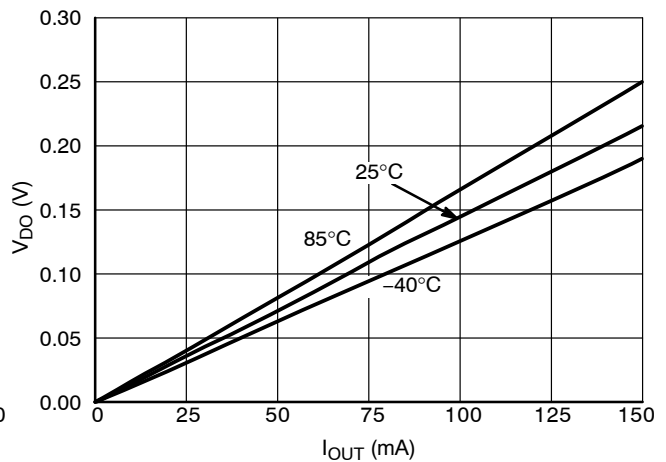

Figure 8. Dropout Voltage vs. Output Current  
5.0 V Version

TYPICAL CHARACTERISTICS

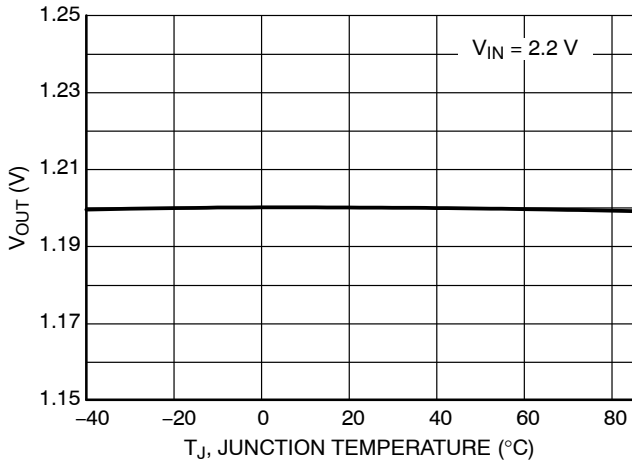

Figure 9. Output Voltage vs. Temperature, 1.2 V Version

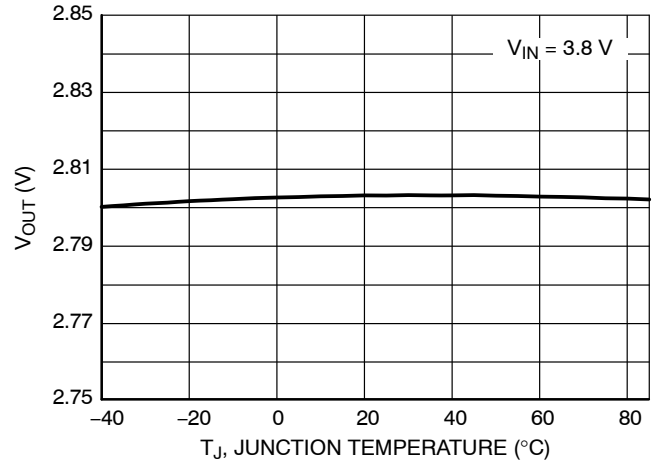

Figure 10. Output Voltage vs. Temperature, 2.8 V version

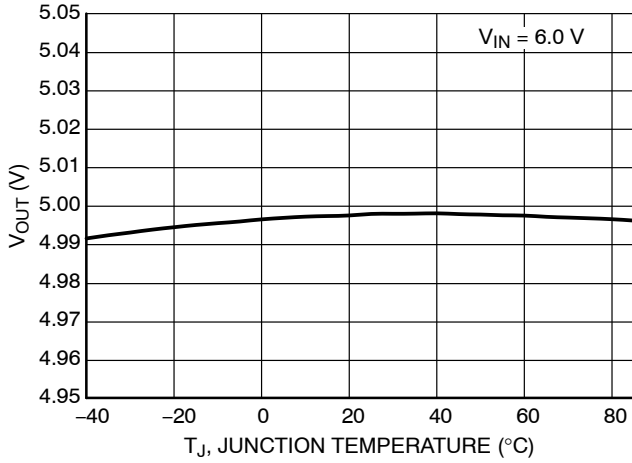

Figure 11. Output Voltage vs. Temperature, 5.0 V Version

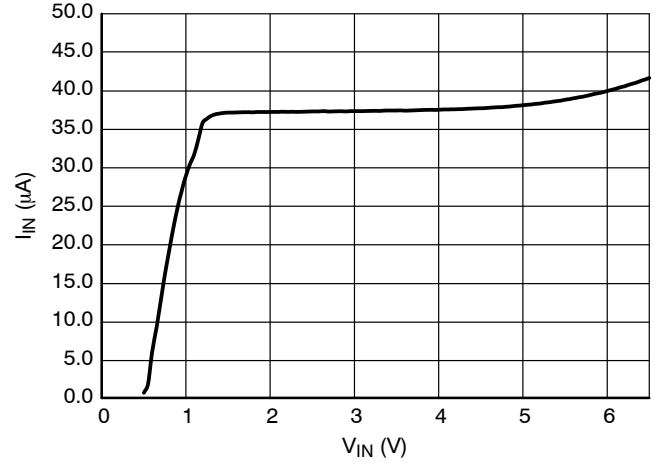

Figure 12. Supply Current vs. Input Voltage, 1.2 V Version

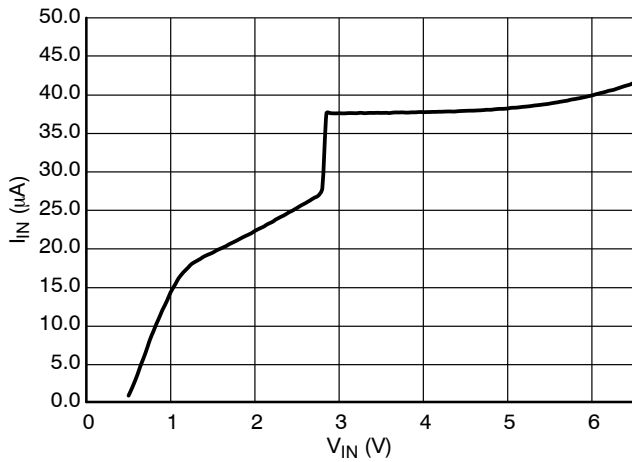

Figure 14. Supply Current vs. Input Voltage, 2.8 V Version

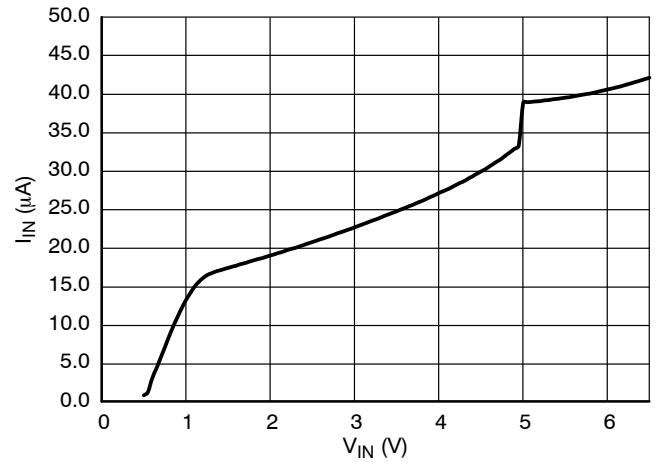

Figure 13. Supply Current vs. Input Voltage, 5.0 V version

TYPICAL CHARACTERISTICS

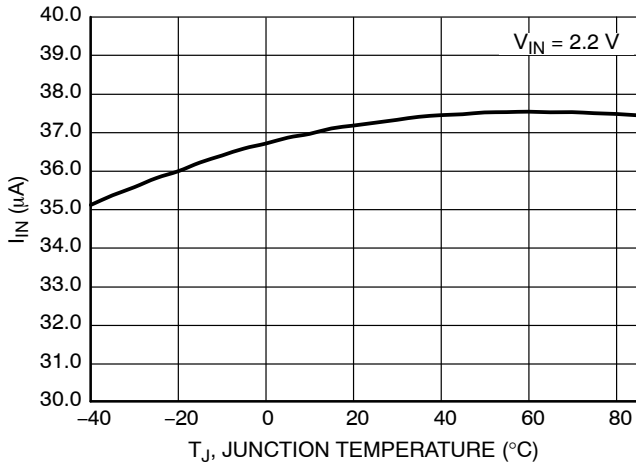

Figure 15. Supply Current vs. Temperature, 1.2 V Version

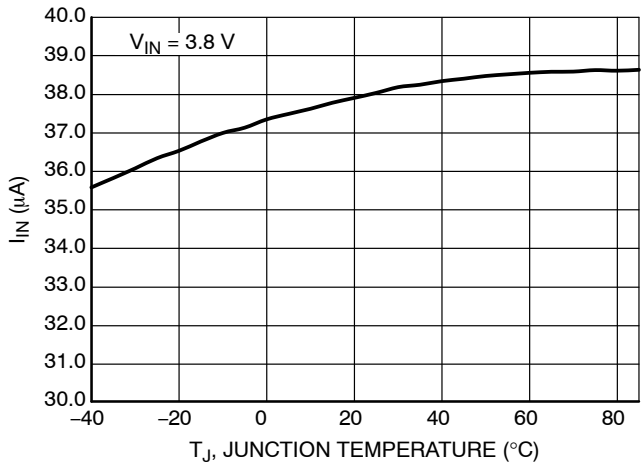

Figure 16. Supply Current vs. Temperature, 2.8 V Version

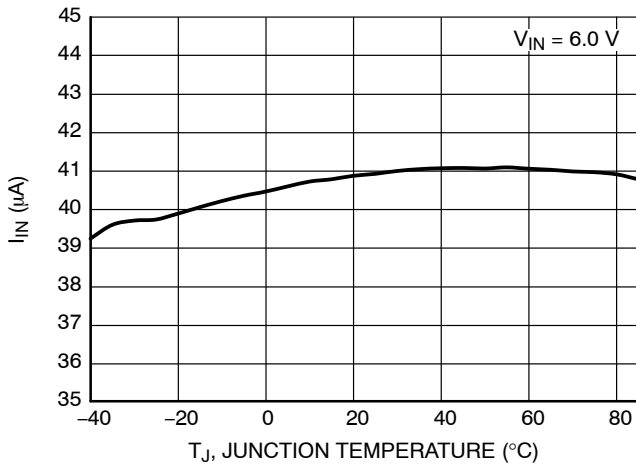

Figure 17. Supply Current vs. Temperature, 5.0 V Version

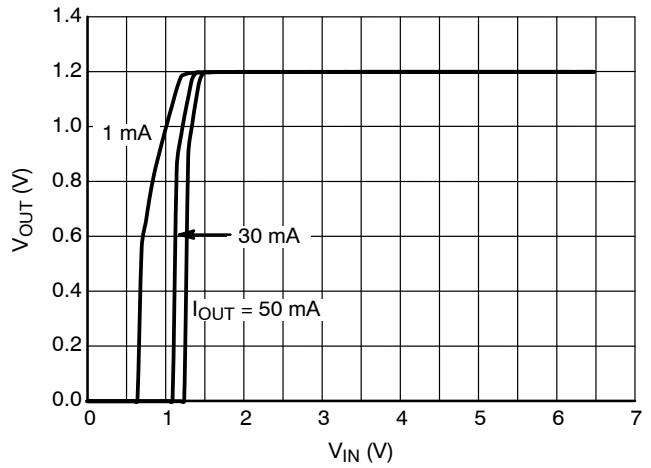

Figure 18. Output Voltage vs. Input Voltage, 1.2 V Version

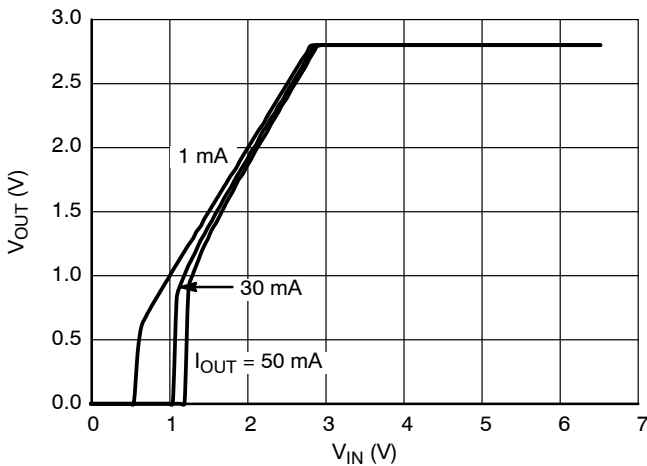

Figure 19. Output Voltage vs. Input Voltage, 2.8 V Version

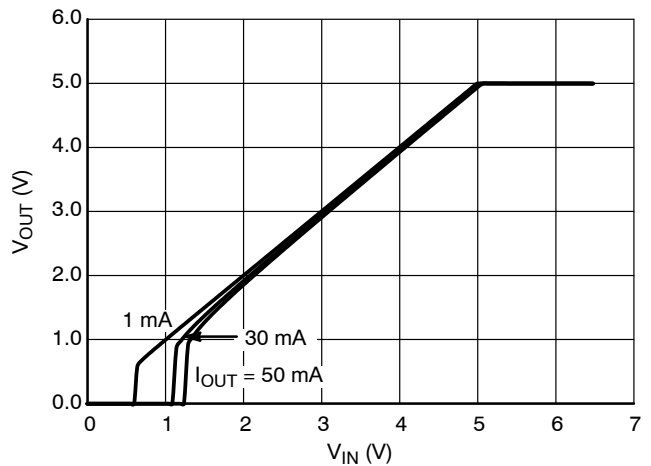

Figure 20. Output Voltage vs. Input Voltage, 5.0 V Version

TYPICAL CHARACTERISTICS

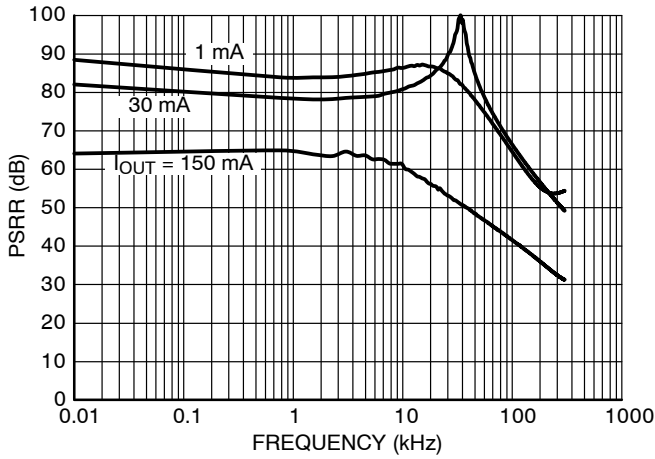

Figure 21. PSRR, 1.2 V Version

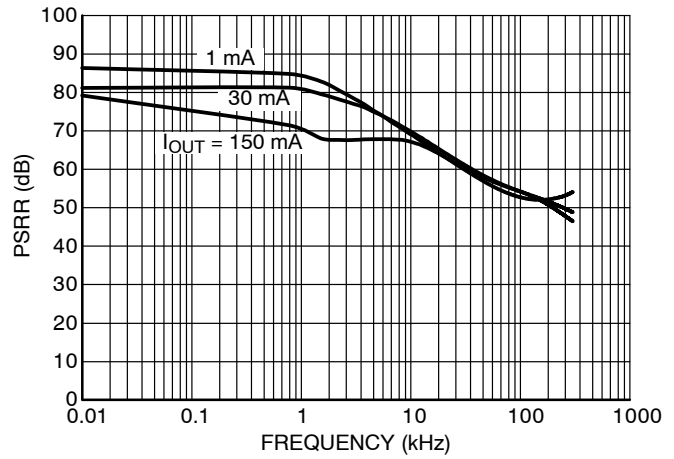

Figure 22. PSRR, 2.8 V Version

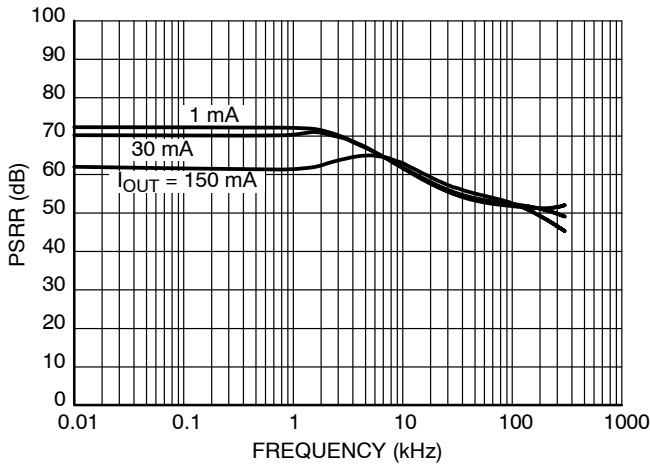

Figure 23. PSRR, 5.0 V Version

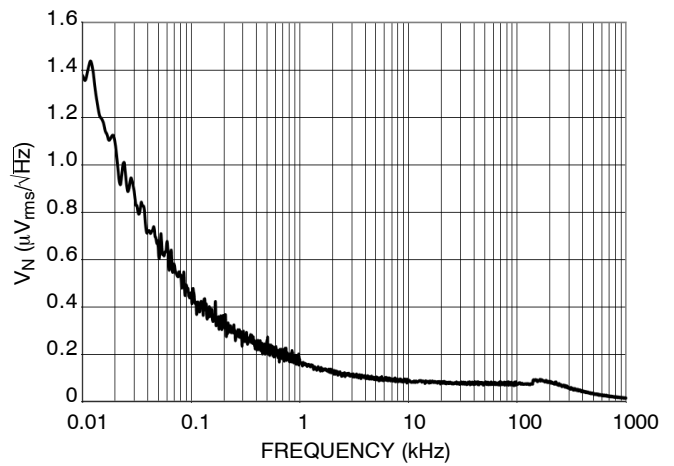

Figure 24. Output Voltage Noise, 1.2 V Version

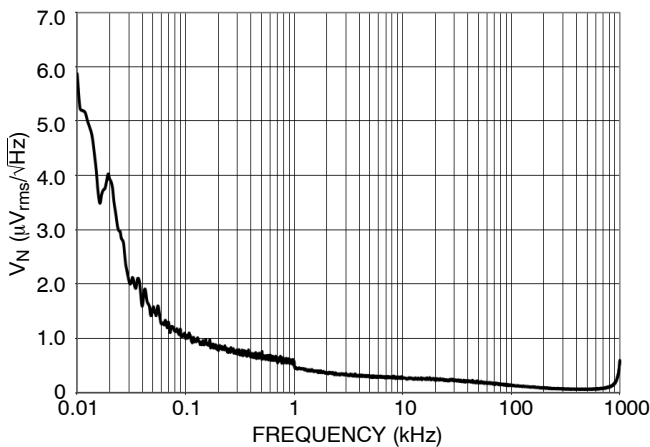

Figure 25. Output Voltage Noise, 2.8 V Version

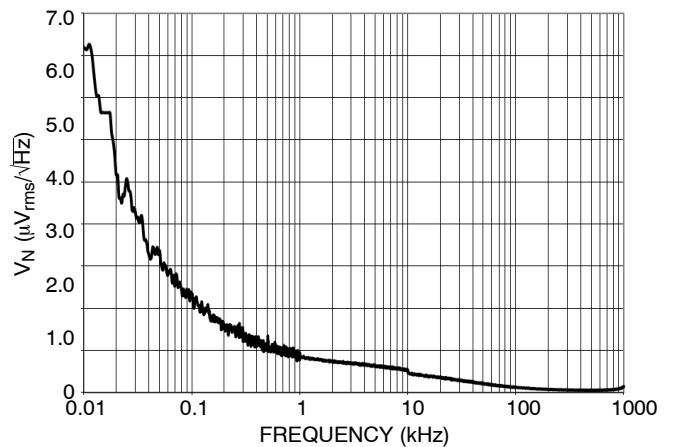
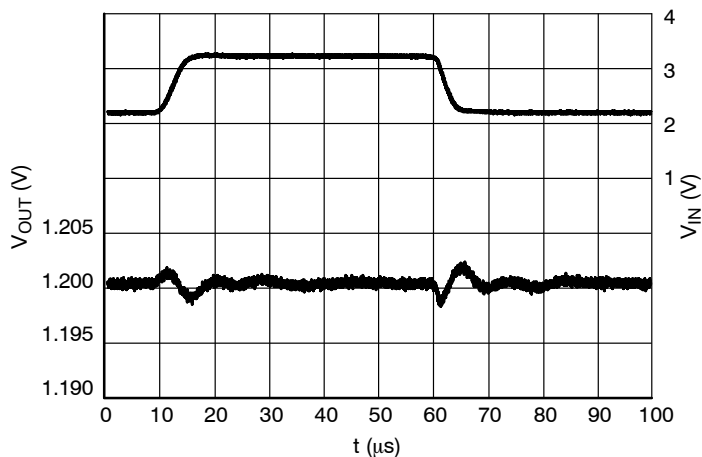

Figure 26. Output Voltage Noise, 5.0 V Version



# NCP4586

## TYPICAL CHARACTERISTICS



**Figure 27. Line Transients, 1.2 V Version,  
 $t_R = t_F = 5 \mu\text{s}$ ,  $I_{OUT} = 30 \text{ mA}$**

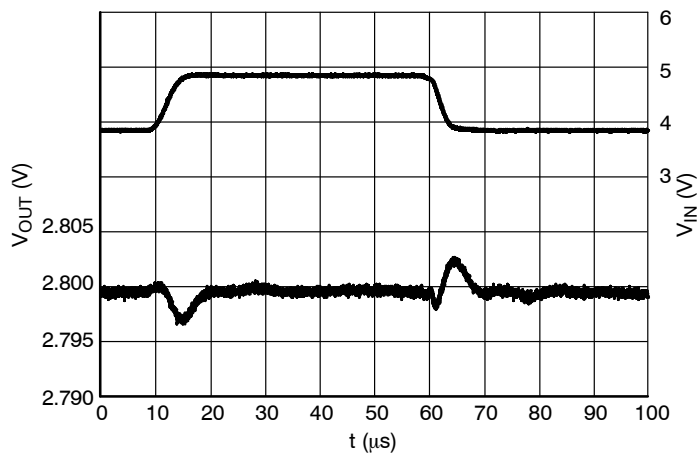

**Figure 28. Line Transients, 2.8 V Version,  
 $t_R = t_F = 5 \mu\text{s}$ ,  $I_{OUT} = 30 \text{ mA}$**

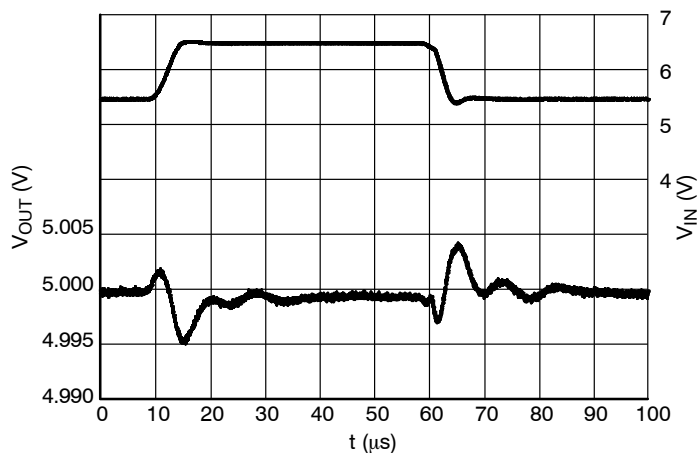

**Figure 29. Line Transients, 5.0 V Version,  $t_R =$   
 $t_F = 5 \mu\text{s}$ ,  $I_{OUT} = 30 \text{ mA}$**

# NCP4586

## TYPICAL CHARACTERISTICS

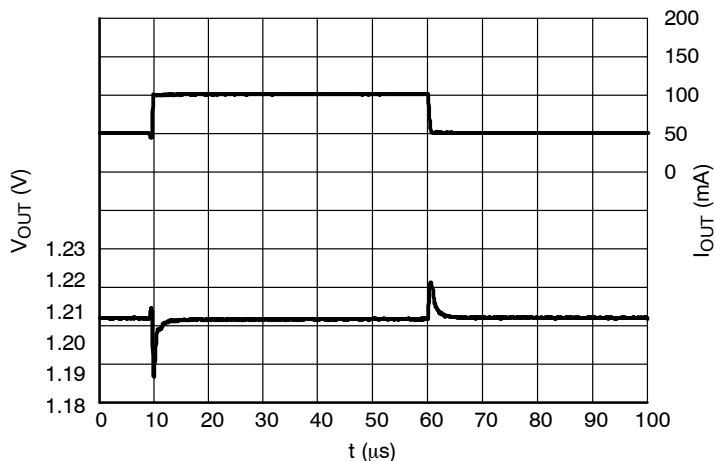

**Figure 30. Load Transients, 1.2 V Version,  
 $I_{OUT} = 50 - 100 \text{ mA}$ ,  $t_R = t_F = 0.5 \mu\text{s}$ ,  $V_{IN} = 2.2 \text{ V}$**

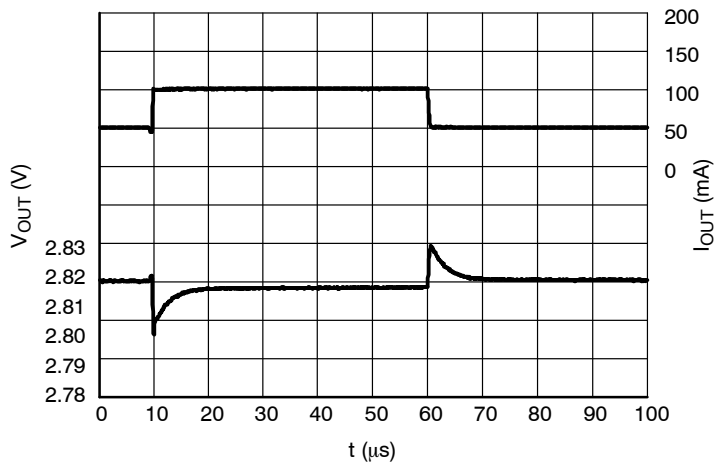

**Figure 31. Load Transients, 2.8 V Version,  
 $I_{OUT} = 50 - 100 \text{ mA}$ ,  $t_R = t_F = 0.5 \mu\text{s}$ ,  $V_{IN} = 3.8 \text{ V}$**

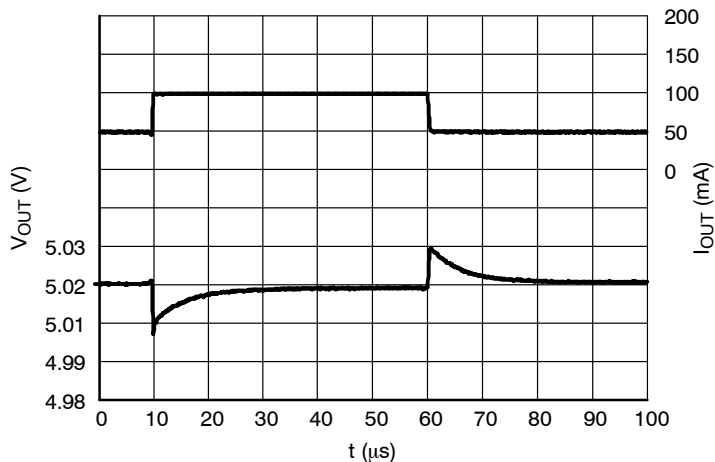

**Figure 32. Load Transients, 5.0 V Version,  
 $I_{OUT} = 50 - 100 \text{ mA}$ ,  $t_R = t_F = 0.5 \mu\text{s}$ ,  $V_{IN} = 6.0 \text{ V}$**

# NCP4586

## TYPICAL CHARACTERISTICS

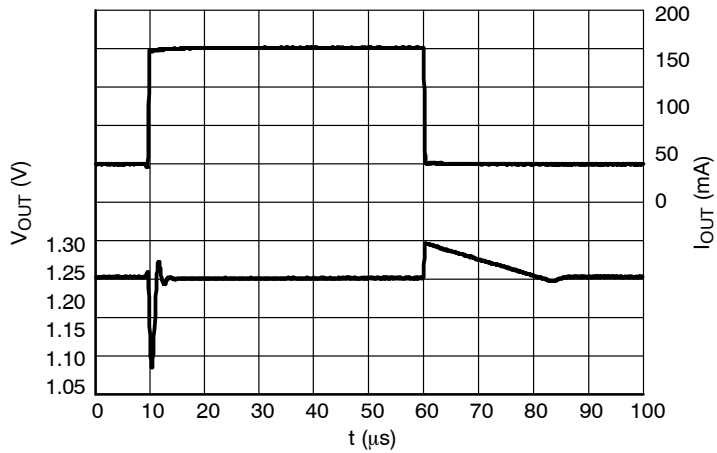

**Figure 33. Load Transients, 1.2 V Version,  
 $I_{OUT} = 1 - 150$  mA,  $t_R = t_F = 0.5 \mu$ s,  $V_{IN} = 2.2$  V**

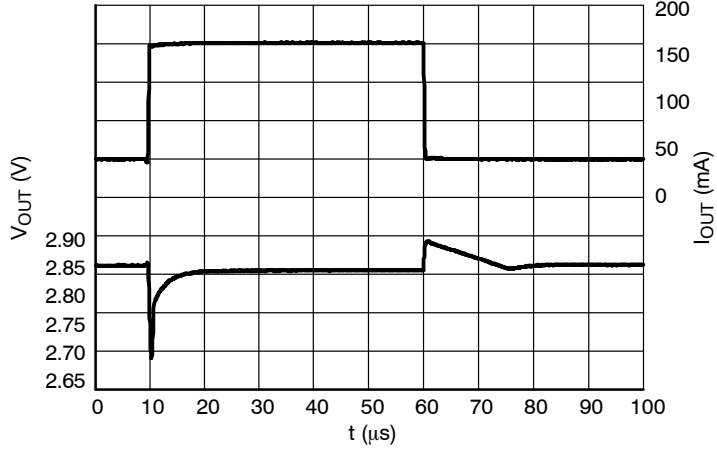

**Figure 34. Load Transients, 2.8 V Version,  
 $I_{OUT} = 1 - 150$  mA,  $t_R = t_F = 0.5 \mu$ s,  $V_{IN} = 3.8$  V**

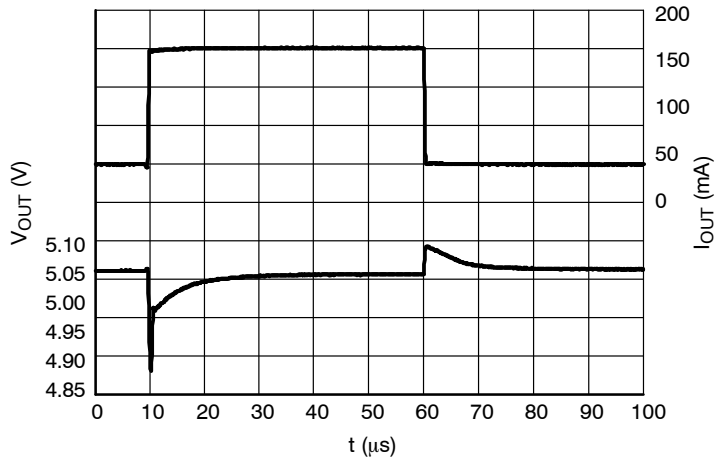

**Figure 35. Load Transients, 5.0 V Version,  
 $I_{OUT} = 1 - 150$  mA,  $t_R = t_F = 0.5 \mu$ s,  $V_{IN} = 6.0$  V**

# NCP4586

## TYPICAL CHARACTERISTICS

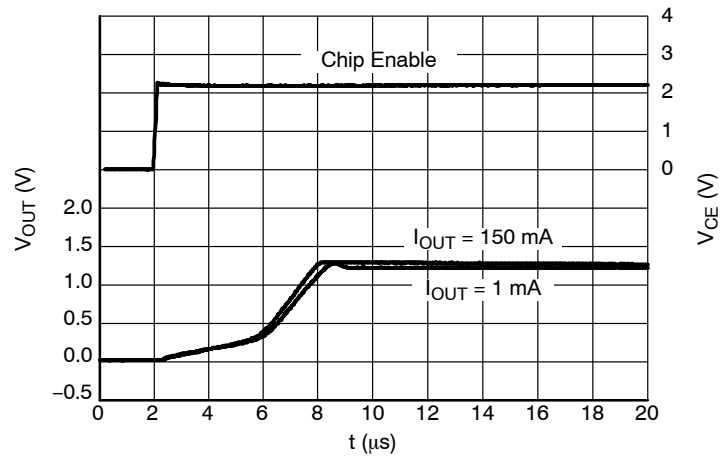

Figure 36. Start-up, 1.2 V Version,  $V_{IN} = 2.2 \text{ V}$

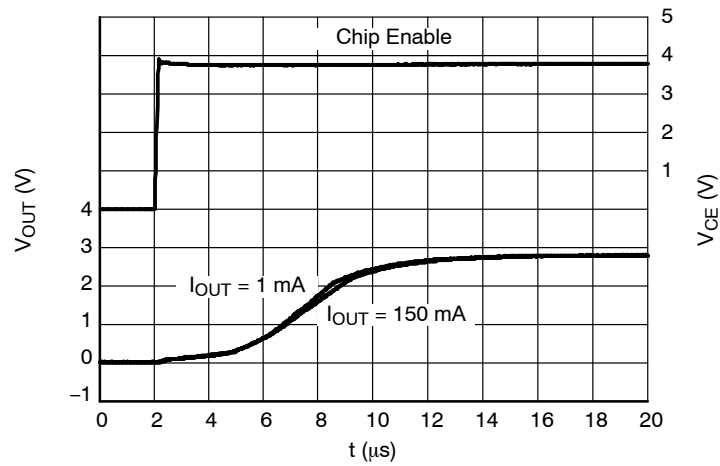

Figure 37. Start-up, 2.8 V Version,  $V_{IN} = 3.8 \text{ V}$

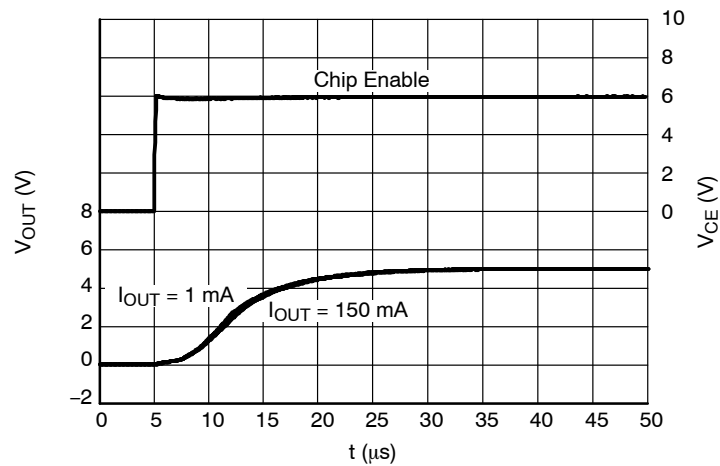

Figure 38. Start-up, 5.0 V Version,  $V_{IN} = 6.0 \text{ V}$

# NCP4586

## TYPICAL CHARACTERISTICS

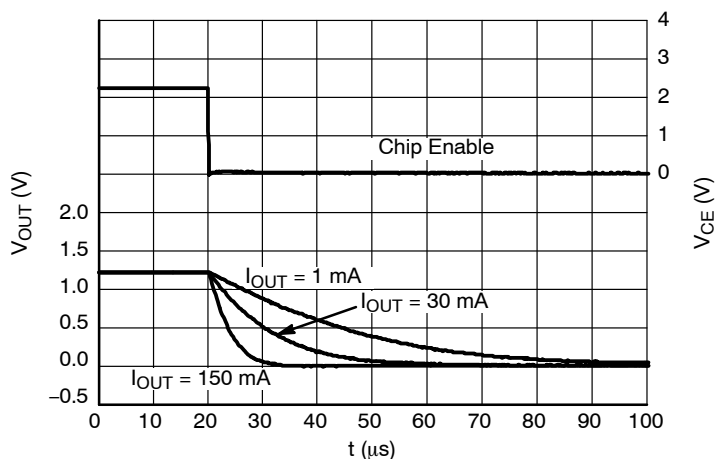

Figure 39. Shutdown, 1.2 V Version D,  
 $V_{IN} = 2.2 \text{ V}$

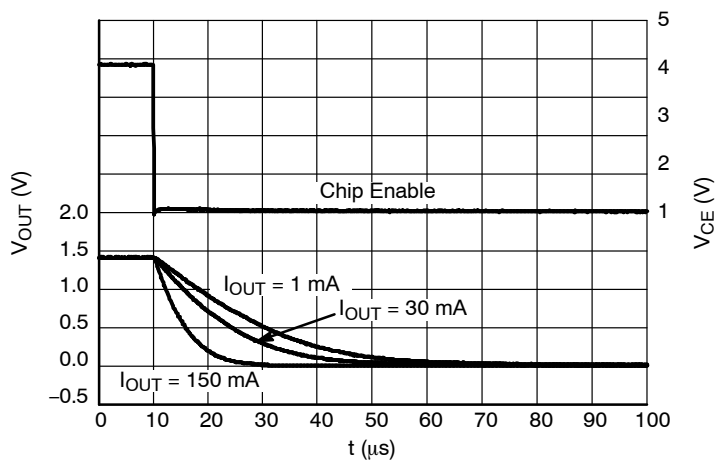

Figure 40. Shutdown, 2.8 V Version D,  
 $V_{IN} = 3.8 \text{ V}$

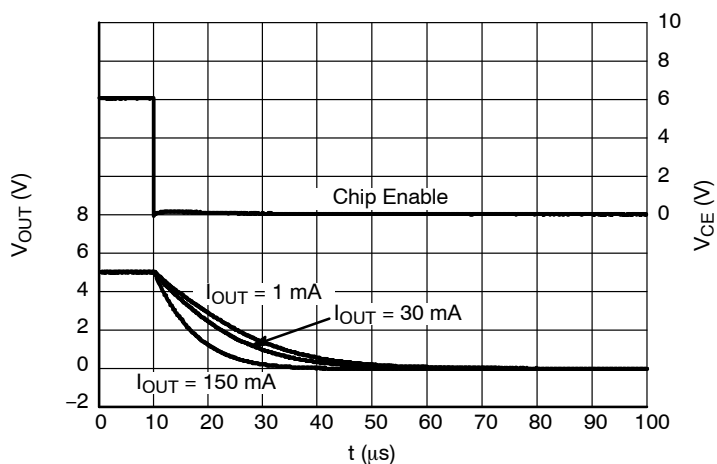

Figure 41. Shutdown, 5.0 V version D,  
 $V_{IN} = 6.0 \text{ V}$

## APPLICATION INFORMATION

A typical application circuit for NCP4586 series is shown in Figure 42.

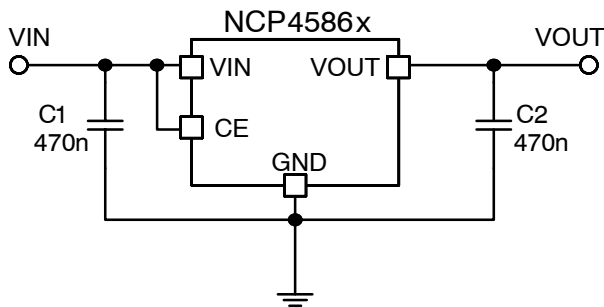

Figure 42. Typical Application Schematic

#### Input Decoupling Capacitor (C1)

A 470 nF ceramic input decoupling capacitor should be connected as close as possible to the input and ground pin of the NCP4586. Higher values and lower ESR improves line transient response.

#### Output Decoupling Capacitor (C2)

A 470 nF or larger ceramic output decoupling capacitor is sufficient to achieve stable operation of the IC. If a tantalum capacitor is used, and its ESR is high, loop oscillation may result. The capacitors should be connected as close as possible to the output and ground pins. Larger values and lower ESR improves dynamic parameters.

#### Enable Operation

The Enable pin  $\overline{CE}$  or CE may be used for turning the regulator on and off. Control polarity is dependent on

version of IC. Active high or low versions are available; please see the ordering information table. The Enable pin has an internal pull down current source for versions H and D. If the enable function is not needed connect the  $\overline{CE}$  pin to ground for version L or connect the CE pin to VIN for versions H and D.

#### Output Discharger

The D version includes a transistor between VOUT and GND that is used for faster discharging of the output capacitor. This function is activated when the IC goes into disable mode.

#### Thermal

As power across the IC increases, it might become necessary to provide some thermal relief. The maximum power dissipation supported by the device is dependent upon board design and layout. Mounting pad configuration on the PCB, the board material, and also the ambient temperature affect the rate of temperature rise for the part. That is to say, when the device has good thermal conductivity through the PCB, the junction temperature will be relatively low with high power dissipation applications.

#### PCB Layout

Make VIN and GND line sufficient. If their impedance is high, noise pickup or unstable operation may result. Connect capacitors C1 and C2 as close as possible to the IC, and make wiring as short as possible.

# NCP4586

## ORDERING INFORMATION

Device	Nominal Output Voltage	Description	Marking	Package	Shipping <sup>†</sup>
NCP4586DSQ12T1G	1.2 V	Enable High, Auto discharge	LA	SC82AB (Pb-Free)	3000 / Tape & Reel
NCP4586DSQ18T1G	1.8 V		LG		
NCP4586DSQ28T1G	2.8 V		MH		
NCP4586DSQ30T1G	3.0 V		NA		
NCP4586DSQ33T1G	3.3 V		ND		
NCP4586DSQ50T1G	5.0 V		QA		
NCP4586DMU12TCG	1.2 V		VA	UDFN4 (Pb-Free)	10000 / Tape & Reel
NCP4586DMU14TCG	1.4 V		VC		
NCP4586DMU15TCG	1.5 V		VD		
NCP4586DMU18TCG	1.8 V		VG		
NCP4586DMU25TCG	2.5 V		VQ		
NCP4586DMU28TCG	2.8 V		VT		
NCP4586DMU30TCG	3.0 V		VW		
NCP4586DMU33TCG	3.3 V		VZ		
NCP4586DMU50TCG	5.0 V		WS		
NCP4586DSN12T1G	1.2 V		H2A		
NCP4586DSN18T1G	1.8 V		H2G		
NCP4586DSN28T1G	2.8 V		H2T		
NCP4586DSN30T1G	3.0 V		H2W		
NCP4586DSN33T1G	3.3 V		H2Z		
NCP4586DSN50T1G	5.0 V		J2S		

<sup>†</sup>For information on tape and reel specifications, including part orientation and tape sizes, please refer to our Tape and Reel Packaging Specifications Brochure, BRD8011/D.

NOTE: To order other package and voltage variants, please contact your ON Semiconductor sales representative.

# MECHANICAL CASE OUTLINE

## PACKAGE DIMENSIONS

ON Semiconductor®



SCALE 2:1

### SOT-23 5-LEAD CASE 1212-01 ISSUE A

DATE 28 JAN 2011

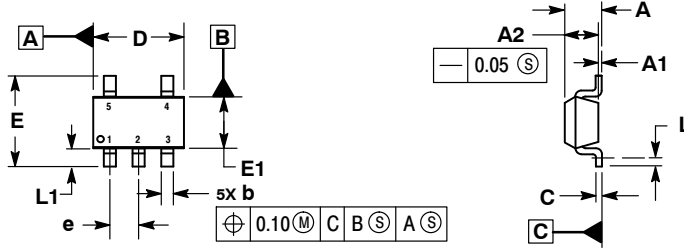

NOTES:

1. DIMENSIONING AND TOLERANCING PER ASME Y14.5M, 1994.
2. CONTROLLING DIMENSIONS: MILLIMETERS.
3. DATUM C IS THE SEATING PLANE.

MILLIMETERS		
DIM	MIN	MAX
A	---	1.45
A1	0.00	0.10
A2	1.00	1.30
b	0.30	0.50
c	0.10	0.25
D	2.70	3.10
E	2.50	3.10
E1	1.50	1.80
e	0.95 BSC	
L	0.20	---
L1	0.45	0.75

### RECOMMENDED SOLDERING FOOTPRINT\*

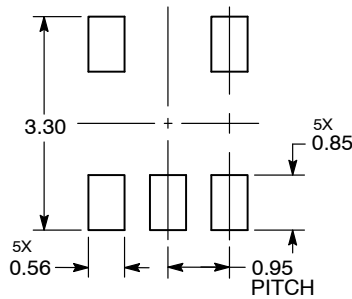

DIMENSIONS: MILLIMETERS

\*For additional information on our Pb-Free strategy and soldering details, please download the ON Semiconductor Soldering and Mounting Techniques Reference Manual, SOLDERRM/D.

### GENERIC MARKING DIAGRAM\*

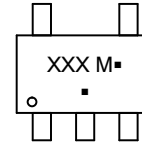

XXX = Specific Device Code

M = Date Code

▪ = Pb-Free Package

(Note: Microdot may be in either location)

\*This information is generic. Please refer to device data sheet for actual part marking. Pb-Free indicator, "G" or microdot "▪", may or may not be present.

<b>DOCUMENT NUMBER:</b>	<b>98ASH70518A</b>	Electronic versions are uncontrolled except when accessed directly from the Document Repository. Printed versions are uncontrolled except when stamped "CONTROLLED COPY" in red.
<b>DESCRIPTION:</b>	<b>SOT-23 5-LEAD</b>	<b>PAGE 1 OF 1</b>

ON Semiconductor and are trademarks of Semiconductor Components Industries, LLC dba ON Semiconductor or its subsidiaries in the United States and/or other countries. ON Semiconductor reserves the right to make changes without further notice to any products herein. ON Semiconductor makes no warranty, representation or guarantee regarding the suitability of its products for any particular purpose, nor does ON Semiconductor assume any liability arising out of the application or use of any product or circuit, and specifically disclaims any and all liability, including without limitation special, consequential or incidental damages. ON Semiconductor does not convey any license under its patent rights nor the rights of others.



# MECHANICAL CASE OUTLINE

## PACKAGE DIMENSIONS

ON Semiconductor®

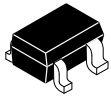

**SC-82AB**  
CASE 419C-02  
ISSUE F

DATE 22 JUN 2012

SCALE 4:1

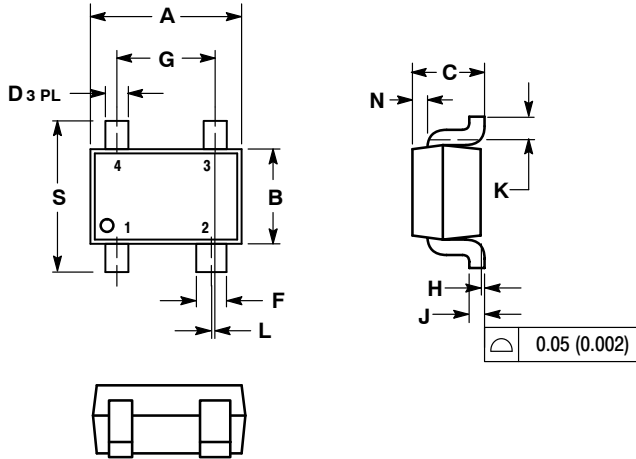

**NOTES:**

1. DIMENSIONING AND TOLERANCING PER ANSI Y14.5M, 1982.
2. CONTROLLING DIMENSION: MILLIMETER.
3. 419C-01 OBSOLETE. NEW STANDARD IS 419C-02.
4. DIMENSIONS A AND B DO NOT INCLUDE MOLD FLASH, PROTRUSIONS, OR GATE BURRS.

DIM	MILLIMETERS		INCHES	
	MIN	MAX	MIN	MAX
A	1.80	2.20	0.071	0.087
B	1.15	1.35	0.045	0.053
C	0.80	1.10	0.031	0.043
D	0.20	0.40	0.008	0.016
F	0.30	0.50	0.012	0.020
G	1.10	1.50	0.043	0.059
H	0.00	0.10	0.000	0.004
J	0.10	0.26	0.004	0.010
K	0.10	---	0.004	---
L	0.05 BSC		0.002 BSC	
N	0.20 REF		0.008 REF	
S	1.80	2.40	0.07	0.09

**SOLDERING FOOTPRINT\***

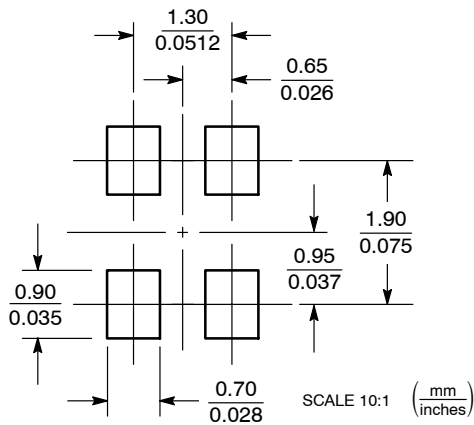

**GENERIC MARKING DIAGRAM\***

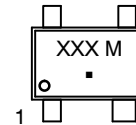

- XXX = Specific Device Code
- M = Month Code
- = Pb-Free Package

\*This information is generic. Please refer to device data sheet for actual part marking. Pb-Free indicator, "G" or microdot "▪", may or may not be present.

\*For additional information on our Pb-Free strategy and soldering details, please download the ON Semiconductor Soldering and Mounting Techniques Reference Manual, SOLDERRM/D.

<b>DOCUMENT NUMBER:</b>	<b>98ARB18939C</b>	Electronic versions are uncontrolled except when accessed directly from the Document Repository. Printed versions are uncontrolled except when stamped "CONTROLLED COPY" in red.
<b>DESCRIPTION:</b>	<b>SC-82AB</b>	<b>PAGE 1 OF 1</b>

ON Semiconductor and are trademarks of Semiconductor Components Industries, LLC dba ON Semiconductor or its subsidiaries in the United States and/or other countries. ON Semiconductor reserves the right to make changes without further notice to any products herein. ON Semiconductor makes no warranty, representation or guarantee regarding the suitability of its products for any particular purpose, nor does ON Semiconductor assume any liability arising out of the application or use of any product or circuit, and specifically disclaims any and all liability, including without limitation special, consequential or incidental damages. ON Semiconductor does not convey any license under its patent rights nor the rights of others.

# MECHANICAL CASE OUTLINE

## PACKAGE DIMENSIONS

ON Semiconductor®



SCALE 4:1

UDFN4 1.0x1.0, 0.65P  
CASE 517BR-01  
ISSUE O

DATE 27 OCT 2010

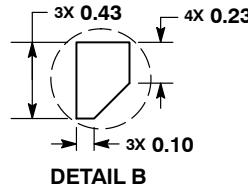
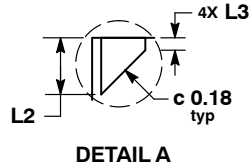
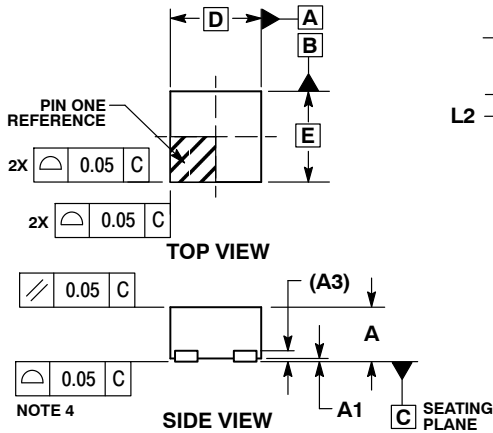

NOTES:

1. DIMENSIONING AND TOLERANCING PER ASME Y14.5M, 1994.
2. CONTROLLING DIMENSION: MILLIMETERS.
3. DIMENSION b APPLIES TO PLATED TERMINAL AND IS MEASURED BETWEEN 0.15 AND 0.20 mm FROM TERMINAL.
4. COPLANARITY APPLIES TO THE EXPOSED PAD AS WELL AS THE TERMINALS.

MILLIMETERS		
DIM	MIN	MAX
A	---	0.60
A1	0.00	0.05
A3	0.10	REF
b	0.20	0.30
D	1.00	BSC
D2	0.43	0.53
E	1.00	BSC
e	0.65	BSC
L	0.20	0.30
L2	0.27	0.37
L3	0.02	0.12

GENERIC MARKING DIAGRAM\*

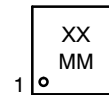

XX = Specific Device Code  
MM = Date Code

\*This information is generic. Please refer to device data sheet for actual part marking.  
Pb-Free indicator, "G" or microdot "▪", may or may not be present.

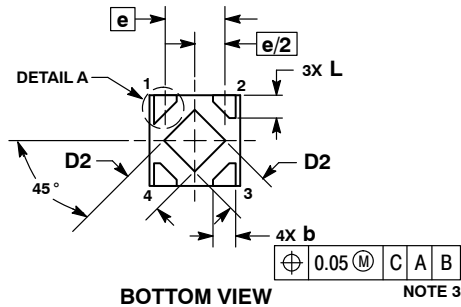

RECOMMENDED MOUNTING FOOTPRINT\*

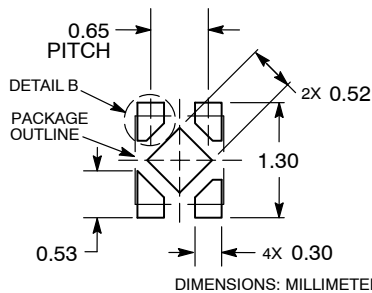

\*For additional information on our Pb-Free strategy and soldering details, please download the ON Semiconductor Soldering and Mounting Techniques Reference Manual, SOLDERRM/D.

DOCUMENT NUMBER:	98AON53254E	Electronic versions are uncontrolled except when accessed directly from the Document Repository. Printed versions are uncontrolled except when stamped "CONTROLLED COPY" in red.
DESCRIPTION:	UDFN4, 1.0X1.0, 0.65P	PAGE 1 OF 1

ON Semiconductor and are trademarks of Semiconductor Components Industries, LLC dba ON Semiconductor or its subsidiaries in the United States and/or other countries. ON Semiconductor reserves the right to make changes without further notice to any products herein. ON Semiconductor makes no warranty, representation or guarantee regarding the suitability of its products for any particular purpose, nor does ON Semiconductor assume any liability arising out of the application or use of any product or circuit, and specifically disclaims any and all liability, including without limitation special, consequential or incidental damages. ON Semiconductor does not convey any license under its patent rights nor the rights of others.

ON Semiconductor and  are trademarks of Semiconductor Components Industries, LLC dba ON Semiconductor or its subsidiaries in the United States and/or other countries. ON Semiconductor owns the rights to a number of patents, trademarks, copyrights, trade secrets, and other intellectual property. A listing of ON Semiconductor's product/patent coverage may be accessed at [www.onsemi.com/site/pdf/Patent-Marking.pdf](http://www.onsemi.com/site/pdf/Patent-Marking.pdf). ON Semiconductor reserves the right to make changes without further notice to any products herein. ON Semiconductor makes no warranty, representation or guarantee regarding the suitability of its products for any particular purpose, nor does ON Semiconductor assume any liability arising out of the application or use of any product or circuit, and specifically disclaims any and all liability, including without limitation special, consequential or incidental damages. Buyer is responsible for its products and applications using ON Semiconductor products, including compliance with all laws, regulations and safety requirements or standards, regardless of any support or applications information provided by ON Semiconductor. "Typical" parameters which may be provided in ON Semiconductor data sheets and/or specifications can and do vary in different applications and actual performance may vary over time. All operating parameters, including "Typicals" must be validated for each customer application by customer's technical experts. ON Semiconductor does not convey any license under its patent rights nor the rights of others. ON Semiconductor products are not designed, intended, or authorized for use as a critical component in life support systems or any FDA Class 3 medical devices or medical devices with a same or similar classification in a foreign jurisdiction or any devices intended for implantation in the human body. Should Buyer purchase or use ON Semiconductor products for any such unintended or unauthorized application, Buyer shall indemnify and hold ON Semiconductor and its officers, employees, subsidiaries, affiliates, and distributors harmless against all claims, costs, damages, and expenses, and reasonable attorney fees arising out of, directly or indirectly, any claim of personal injury or death associated with such unintended or unauthorized use, even if such claim alleges that ON Semiconductor was negligent regarding the design or manufacture of the part. ON Semiconductor is an Equal Opportunity/Affirmative Action Employer. This literature is subject to all applicable copyright laws and is not for resale in any manner.

## PUBLICATION ORDERING INFORMATION

### LITERATURE FULFILLMENT:

Email Requests to: [orderlit@onsemi.com](mailto:orderlit@onsemi.com)

ON Semiconductor Website: [www.onsemi.com](http://www.onsemi.com)

### TECHNICAL SUPPORT

North American Technical Support:  
Voice Mail: 1 800-282-9855 Toll Free USA/Canada  
Phone: 011 421 33 790 2910

### Europe, Middle East and Africa Technical Support:

Phone: 00421 33 790 2910

For additional information, please contact your local Sales Representative

